



Physics Area - PhD course in Theoretical Particle Physics

SISSA, Trieste

**ASPECTS OF SUPERSYMMETRY:
DUALITY, SYMMETRY ENHANCEMENT AND
(SUPER)-POWER OF DECONFINEMENT**

Supervisor:
Sergio Benvenuti

Candidate:
Stéphane Bajet

ACADEMIC YEAR 2022/2023

*Une erreur peut être juste si celui qui l'a
commise s'est trompé*

— Marcel Premat, *dit Bozon*

Acknowledgments

Let's start this thesis by, probably, the most important things, the acknowledgments (for sure it is the case for my family). These acknowledgments will be written in English, in French and in Italian but mostly in the two Latin languages. I would say it is emblematic of my evolution during these four years in SISSA.

La prima persona che voglio ringraziare per la mia avventura è il mio advisor Sergio Benvenuti. Sergio è stata la migliore scelta possibile, sia a livello della fisica che a livello umano. Lavorare con lui è stata una grande esperienza. Sergio ha un'intuizione incredibile e le sue previsioni sono quasi sempre corrette, è stupefacente. Fuori della fisica, è interessato a molte cose e ha sempre una opinione interessante. Ho sempre imparato qualcosa parlando con lui. Ho forse un piccolo rimpianto per non averne approfittato abbastanza. Sergio, ti ringrazio per la tua disponibilità, la tua gentilezza e la tua pazienza con me. Non ho dubbi che il mio dottorato sarebbe stata un'esperienza più difficile con un altro advisor.

Continuando con il lavoro, ringrazio Matteo Sacchi. È stato un piacere lavorare con te. Sei super bravo e ti auguro il meglio per il resto della tua carriera.

I would like now to thank Antonio Amariti, Riccardo Argurio, Noppadol Mekareeya and Sara Pasquetti to kindly accept to be my referees.

Ringrazio anche i professori della SISSA per la fantastica formazione che ho ricevuto durante il mio primo anno: Francesco Benini, Giulio Bonelli, Serguey Petcov, Lorianò Bonora, Roberto Percacci, Marco Serone e specialmente Matteo Bertolini per il suo corso di supersimmetria che mi ha fatto venir voglia di continuare in questo campo.

I thank my two office mates Riccardo Ciccone and Niloofar Vardian for having faced the PhD with me (and also having survived three years in let's say not the best office in SISSA). Thank you also to my two TPP peers Eyoab Bahiru and Mehmet Gumus (Mehmet I'm still waiting your Turkish meal you promised me). Enjoy guys!

Thank you also to the Post-Docs of SISSA. In particular, Christian Copetti for his numerous stories and Jesse van Muiden for his kindness (Jesse I promise that we will hang out soon).

Durante questi quattro anni a Trieste ho avuto la fortuna di conoscere persone fantastiche che mi hanno fatto sentire a casa e che desidero ringraziare. È anche grazie a loro che ho imparato a parlare la lingua di Dante¹ (con una tecnica didattica, diciamo, efficace). Cristoforo,

¹Pero non parlo ancora molto bene l'italiano e lo scrivo con ancora più difficoltà. Avrò quindi degli errori e dei modi di parlare un po' strani. Quindi chiedo scusa ai miei amici italiani ma non voglio che venga corretto perché lo trovo più rappresentativo di chi sono in questo preciso momento.

Daniele, Diego, Diego 2, Fra Addari, Fra Garosi, Giovanni Rizi, Mavi, Saman and Vania per aver reso i pranzi alla SISSA e le numerose serate interessanti e divertente.

Alice, Costi, Paola e Valeria per essere delle ottime compagne di ballo di salsa o di swing. Anche a Giulio chi, tra l'altro altre cose è il maestro di swing e me lo ha fatto conoscere.

Davide, Dani, Jacopo, Igor e Valentina per aver scoperto con me le magnifiche montagne intorno a Trieste.

Cristiano per aver condiviso i momenti sportivi tra il calcio e lo sci (e anche per avermi guidato così tante volte).

Stefano Alessandro Baggioni che mi ha fatto capire tante cose su di me.

Andrea, Delpo, Fabi, Francesca, Giua e Max. Abbiamo condiviso e scoperto così tante cose durante questi tre/quattro anni. Passeggiate in montagna con alcuni, lo sci con altri e barca tutti insieme. Grazie anche per aver fatto tutti i ristoranti di Trieste (giuro un giorno andiamo da Harry's) e per essere venuti a casa mia in Francia, è stato proprio bello. Grazie a te, Max per avermi mostrato i posti più belli della Puglia. A te Francesca, chi ha sempre cercato di includermi quando ero l'unico a non parlare italiano (dai anche tu Delpo ti piaceva parlare in inglese). Finalmente a te Fabi. Tu, che per due anni ti sei rifiutato di parlarmi finché hai giudicato il mio livello di italiano abbastanza accettabile (mentre, ironia della sorte, parli molto bene il francese). Sei diventata la persona con cui parlo di più.

Fuori dell'ambiente della SISSA, voglio ringraziare miei amici di pugilato Alberto, Anna, Eleonora, Elton e Nicolo per aver condiviso con me il dolore dell'allenamento. Anche grazie a Andrea per tutti i sparring sotto lo sguardo di coach Rico.

Je peux maintenant revenir dans ma langue maternelle pour remercier mes amis de Thonon (entendu au sens large) et ma famille.

Tout d'abord William, mon pote de l'EPFL. À chaque fois qu'on a eu l'occasion de se revoir, rien n'avait changé comme si on avait quitté SAT la semaine dernière. Je te remercie pour ça. Tu t'es lancé aussi dans un doctorat et je te souhaite de t'éclater en le faisant.

Kévin, c'est toujours un plaisir quand on arrive à se voir. Ne change pas, t'es un super mec. Je te souhaite de continuer à t'épanouir avec ta petite famille et dans ton boulot (en espérant quand même ne pas avoir besoin de tes services prochainement).

Jules et Romain, ça fait maintenant une paille qu'on se connaît. Je vous remercie pour toutes ces années, pour toutes ces soirées, ces rigolades et bons repas partagés. Je vous souhaite le meilleur les mecs, en particulier avec Anastasia pour toi Jules (t'inquiètes Rom, tu vas en retrouver une très rapidement).

Clem, on se connaît depuis la première année de maternelle. Je te remercie pour toutes ces discussions qu'on a eues. Notamment sur le monde de la recherche que tu connais bien toi aussi. C'est toujours inspirant et enrichissant d'échanger avec toi. Je te souhaite de continuer à t'épanouir dans ton travail que tu aimes tant et bonne chance pour ta nouvelle aventure à Zurich (c'est beau, tu te rapproches aussi de chez nous).

Steve, mon acolyte depuis le lycée. Merci pour tous ces fous rires. Merci pour ces conver-

sations qui partaient d'une connerie pour finir sur quelque chose de sérieux et important. Je te remercie pour tous les conseils de vie que tu m'as donnés, je ne les ai peut être pas tous suivis, mais ils m'ont toujours donné le sourire. Continue à bien prendre soin de ta famille mon ami.

Enfin Val. Tu as fait partie pratiquement de tous les moments importants de ma vie ces 15 dernières années et cela va continuer sans aucun doute. Tu m'as toujours soutenu et aidé quand je devais prendre des décisions en faisant preuve d'une honnêteté sans faille. Tu as contribué grandement à celui que je suis devenu aujourd'hui. Je te remercie pour tout. Je te souhaite de continuer à grandir et d'être heureux avec Adeline. Je n'ai pas d'inquiétude pour ça, c'est une fille en or.

Merci de m'avoir toujours rappelé où était chez moi à chaque fois que je rentrais.

Je voulais finir par remercier les membres de ma famille.

Tous mes cousins, Kévin, Céline, Antoine, Julie, Léane et Florian ainsi que mes oncles et tantes Fred, Joëlle, Catherine, Jean-Remy, Jacqueline et Didier pour les bons Noëls passés ensemble aussi bien en Bretagne qu'en Haute-Savoie.

Il y a aussi les Parrish, Denise, Malcolm, Béré, Neil et Oscar. Je vous remercie pour votre joie de vivre et ces bons souvenirs, de Deauville à Monaco en passant par Paris et Lyon. Une pensée pour toi Oscar, mon filleul. Continue comme ça, tu es parti pour être quelqu'un de très intéressant.

Bien sur Renée, pour ta gentillesse. A chaque fois que je suis rentré tu as toujours tenu à nous réunir et faire un magnifique repas. Cela a toujours été des moments importants.

Ma grand-mère Paulette. Tu t'es toujours dévouée pour tes petits enfants, tu nous as gâtés et moi en particulier. Tu m'as toujours fait sentir que j'étais spécial (justifié ou non c'est une autre question). Je te remercie pour ton dévouement durant toutes ces années.

À mon frère Nicolas et ma soeur Anne-Sophie. On a beau être différent et ne pas avoir fait la même chose, vous êtes les personnes dont qui j'ai le plus appris. Vous êtes tous les deux brillants dans vos domaines et avez été, et êtes encore des sources d'inspirations pour moi. Je vous remercie et à nous de préserver ce lien.

À Yannick et Isabelle, mes parents. Vous avez réussi cette prouesse d'être toujours présents tout en me laissant une totale liberté. Vous avez cette qualité incroyable de simplifier la vie des gens que vous côtoyez, quelque chose que j'admire beaucoup. Je vous remercie pour le soutien que vous n'avez cessé de m'apporter dans tous les projets que j'ai entrepris. Je vous remercie peut être encore plus pour la famille que vous avez créée. Je suis le seul responsable de tout ce que j'ai raté, mais dans toutes mes réussites vous avez eu un rôle essentiel et ce doctorat ne fait pas exception.

Une pensée pour toi mamie Hélène qui est partie quelque peu avant la fin de mon aventure italienne. À toi papi Marcel, parti quelques années plus tôt. Enfin à toi, mon frère Sébastien, à jamais dans mon coeur. Je vous dédie cette thèse.

Abstract

This thesis is devoted to the study of different non-perturbative aspects of supersymmetric quantum field theory (SQFT). We analyze SQFTs living in different space-time dimensions and preserving different number of supercharges but with a special emphasis to the minimally supersymmetric theories in $4d$ ($\mathcal{N} = 1$).

In the first part of this thesis, we generalize a technique called sequential deconfinement allowing us to prove various $4d \mathcal{N} = 1$ infrared (IR) dualities by iterative use of more fundamental ones. It includes all the S-confining dualities, meaning gauge theories dual to a Wess-Zumino model, with simple gauge group, vanishing superpotential and matter fields transforming in rank-1 and/or rank-2 representations. As well as the self-duality of the $4d \mathcal{N} = 1$ $USp(2N)$ gauge theory with an antisymmetric field and 8 fundamentals.

In the second part, we consider $5d$ KK-dualities, that is multiple $5d$ gauge theories with the same $6d$ infinite coupling limit. Then we use these KK-theories to construct new non-trivial $4d \mathcal{N} = 1$ IR dualities.

In the last part, we propose new classes of $4d \mathcal{N} = 1$ S-confining gauge theories and discuss some $3d$ reductions. These $3d$ S-confining theories provide an understanding of a recently proposed $4d \mathcal{N} = 1$ theory that flows to the same conformal manifold of $\mathcal{N} = 4$ super Yang-Mills with $SU(2N+1)$ gauge group. The $3d$ perspective allows us to generalize the construction by providing another example of a flow with supersymmetry enhancement.

Declaration

I hereby declare that, except where specific reference is made to the work of others, the contents of this thesis are original and have not been submitted in whole or in part for consideration for any other degree or qualification in this, or any other university.

The discussion is based on the following published works:

- S. Bajet, S. Benvenuti, *S-confinements from deconfinements*, JHEP **11** (2022) 071, [arXiv:2201.11049] [1]
- S. Bajet, S. Benvenuti, *Sequential deconfinement and self-dualities in $4d\mathcal{N} = 1$* , JHEP **10** (2022) 007, [arXiv:2206.11364] [2]
- S. Bajet, S. Benvenuti, *$4d\mathcal{N} = 1$ dualities from $5d$ dualities*, [arXiv:2212.11217] [3]
- S. Bajet, S. Benvenuti, M. Sacchi, *S-confining gauge theories and supersymmetry enhancements*, JHEP **08** (2023) 042, [arXiv:2305.10274] [4]

Contents

1	Introduction	15
2	Basics of supersymmetric quiver gauge theories	27
2.1	Quick review of $4d\mathcal{N} = 1$ and $3d\mathcal{N} = 2$ theories	27
2.1.1	$4d\mathcal{N} = 1$ basics:	27
2.1.2	$3d\mathcal{N} = 2$ basics:	33
2.2	Chiral ring	40
2.3	Notation for quiver gauge theories	40
2.4	Anomalies and t’Hooft anomaly matching	42
2.5	a -maximization	44
2.6	$4d\mathcal{N} = 1$ IR duality	45
2.6.1	Seiberg-like dualities	46
2.6.2	Kutasov–Schwimmer-like dualities	48
2.6.3	Self-dualities modulo flips	50
2.7	$3d\mathcal{N} = 2$ Seiberg-like dualities	51
2.8	Classification S-confining theories	52
2.9	Deconfinement method	55
2.10	$4d\mathcal{N} = 1$ supersymmetric index	59
3	Power of deconfinement	63
3.1	Introduction	63
3.2	Proof of the S-confining theories	64
3.2.1	$USp(2N)$ with $\square + 6\square$ series	64
3.2.2	$SU(M)$ with $\square, \bar{\square} + 3\square + 3\bar{\square}$ series	68
3.2.3	$SU(M)$ with $\square + M\bar{\square} + 4\square$ series	77
3.2.4	Four ‘sporadic’ cases: $SU(5), SU(6), SU(7)$	80
3.3	Sequential deconfinement of $4d\mathcal{N} = 1$ gauge theories	94
3.3.1	Case study: $USp(6)$ with $\square + 8\square$	94
3.3.2	General case: $USp(2N)$ with $\square + 2F\square$	100
3.4	Reconfinement and self-duality for $USp(2N)$ with $\square + 8\square$	105
3.5	Reduction to $3d\mathcal{N} = 2$ sequential deconfinement	110

3.6	Outlook	115
4	$4d \mathcal{N} = 1$ dualities from $5d$ dualities	117
4.1	Introduction	117
4.2	First class: rectangular pq-webs, the $R_{N,k}$ theories	118
4.2.1	A simple class: $R_{N,2}$ and its two duals	118
4.2.2	Generalization: the $R_{N,k}$ theories	124
4.3	Second class: systems with two $O7$ planes, the $A_{n,m}$ theories and its dual	133
4.3.1	A simple class: $A_{n,1}$ theory	133
4.3.2	Generalization: the $A_{n,m}$ theories	139
4.4	Higgsing of $R_{N,k}$	150
4.5	Outlook	153
5	New S-confining theories and supersymmetry enhancement	155
5.1	Introduction	155
5.2	New $4d$ and $3d$ S-confining theories with cubic superpotential	158
5.2.1	Theories with $\mathcal{W} \sim \phi pp$	158
5.2.2	Theories with $\mathcal{W} \sim \phi^3 + \phi qq$	163
5.3	Derivation of the S-confining dualities	167
5.3.1	Derivation of $\mathcal{U}_2[n, h]$	167
5.3.2	Derivation of $\mathcal{A}_2[n, h]$	170
5.3.3	Derivation of $\mathcal{U}_1[n]$	171
5.4	Understanding $4d$ SUSY enhancements using $3d$ S-confining dualities	173
5.4.1	$4d \mathcal{N} = 1$ theory flowing to $\mathcal{N} = 4$ SYM	174
5.4.2	$4d \mathcal{N} = 1$ theory flowing to an $\mathcal{N} = 2$ necklace quiver	177
5.5	Outlook	185
A	Superpotential of Section 3.2.1 in frame \mathcal{T}_k	187
B	R-charges and degenerate holomorphic operator ambiguity in the generic frame \mathcal{T}_k of Section 3.3.2	195
C	Matching of 't Hooft anomaly matching	199
C.1	Matching of 't Hooft anomalies for the duality of Section 4.3.2	199
C.2	Matching of 't Hooft anomalies for the duality of Section 5.2	202
D	Deconfinement derivation for $\mathcal{U}_1[2]$	207
E	$\mathcal{N} = 1$ conformal manifolds of $\mathcal{N} = 2$ necklace quivers	209

Chapter 1

Introduction

Quantum field theory (QFT) is a pillar of theoretical physics. QFT emerges as the unification between quantum mechanics and special relativity. It is by now unavoidable, present in so many domains of physics that we can affirm, without taking too much risk, that it will still be the basis of physics in the 21st century. Let us name a few of these domains

- Particle physics. The field that gave birth to QFT and which culminates with the Standard Model (SM), a particular type of QFT which describes our world with an incredible accuracy. Some of the predictions of the SM have been verified experimentally with the greatest precision in human history. It is still an ongoing quest to study the SM and physics beyond it [5].
- Condensed Matter Physics. The study of symmetry breaking, phase transitions and phases of matter are crucial concepts in condensed matter physics and QFT is well suited to study them.
- Statistical Physics. QFT techniques, contribute to the understanding of universal aspects of critical phenomena and phase transitions in statistical physics. We can give for example the computation of the critical exponents.
- Quantum Gravity (QG). The ultimate quest of unifying all forces of nature including gravity. String theory (ST), the leading candidate for such unification is written in a QFT language. The holography principle also establishes a clear connection between QFT and ST. See the following reports highlighting further this relationship between QFT and ST [6–8].
- Cosmology. QFT is applied in cosmology, particularly in the context of inflationary theory, to model the dynamics of fields during the early universe, explain the origin of cosmic structures, and provide a theoretical framework for understanding the observed features of the cosmos at large scales. QFT in curved background is used to describe the thermodynamics of black holes [9].
- Mathematics. QFT has provided valuable tools for understanding and classifying three-dimensional manifolds, particularly in the field of topology and knot theory [10, 11].

- Finance. At first we can think of it as a joke but quantum finance is an emerging field that explores the mathematical underpinning of QFT to formulate a comprehensive mathematical theory of asset pricing as well as of interest rates [12]. We included this example to illustrate the importance of QFT and its potential use outside of physics.

However QFT has a problem¹ and an obvious one, it is hard to solve. In the generic situation, it is almost impossible to do any exact computation. Usually we can do computations only in some regime of the parameters defining the theory. When one of the parameters is small, we said that we are in a weak coupling regime and we can use perturbation theory to do computations. This has been the most successful strategy to obtain results in QFT. One of the main reasons why it is so hard to do computations in QFT (but at the same time the source of its richness and beauty) is the renormalization group (RG) flow. It is the idea that the couplings of the theory depend on the energy scale. Going to low energy, following the RG flow, usually some coupling becomes strong. Perturbation theory breaks down and we lose computational control. Some remarkable phenomena could occur along this flow like confinement, symmetry enhancements and dualities. This is what we will be the main focus of this thesis.

In order to study these phenomena, we will restrict to a particular class of QFT called supersymmetric quantum field theory (SQFT). Supersymmetry (SUSY) is a symmetry under the exchange of bosons and fermions [13–17]. It is a space-time symmetry and the only possible extension of the Poincaré symmetry [18]. One objection we can immediately rise is the following, our world as we observe now (including all particles experiments that have been done) is non-supersymmetric. We can then ask: why should we study SUSY theories? There are, of course, good reasons to explore them²:

- SUSY is still a viable extension of the SM and not ruled out as a symmetry of nature [19–21].
- SUSY is crucial in string theory to ensure the consistency of the theory [22, 23].
- SUSY as application in mathematics. Most often, when there is a relationship between theoretical physics and pure mathematics SUSY is involved [10, 11]. To give one particular example, by studying some SUSY theories there have been conjectures about some integral identities that have been later proven by mathematicians [24–27].
- SUSY offers tools to study strong coupling phenomena and obtain exact results that are out of reach for ordinary QFTs. Therefore SQFT is a useful playground to study QFT because of this gain of computational power.

Let us expand a little bit on the last point because it is in this spirit that SUSY has been used in this thesis. An important example of the power of SUSY is through localization, see [28] for a review. It is a technique used to compute exactly partition function and others conserved quantities in SUSY theories defined on some compact manifolds (like spheres S^d).

¹Probably here the word problem is not well suited. There is no a priori reason why it should be possible to describe nature in an easy way by humans.

²Therefore good reasons to pay a PhD student to do it.

There are, of course, limitations to this technique. It cannot be applied to correlators of generic local operators and it can be used only to Lagrangian theories. However for the class of observables to which localization works, it offers the opportunity to study the full non-perturbative answer. Therefore it is a precious tool to inspect interacting SQFT. It turns out that some of these observables (for example the partition functions on some compact manifolds like the superconformal index [29, 30]) are invariant along the RG flow. We can therefore use the ultraviolet (UV) description to compute these quantities and have access to some IR properties that are hard to get. It is therefore an extremely valuable tool.

For now on, let us review in turn the phenomena that will play an important role in this thesis.

The first one is confinement. It is an important scenario that can occur in the IR of gauge theories. It is the idea that at low energy the correct set of degrees of freedom (d.o.f) to describe the IR physics should be gauge singlets of the UV gauge theory. This is the phenomenon that is conjectured to happen in real world quantum chromodynamics (QCD) and is generally summarized by saying that quarks are confined inside hadrons. It is a long-standing problem (even a millennial problem [31]) to have a mathematical proof of this conjecture. When adding SUSY, the situation is under better analytical control. Let us review a little bit the situation in $4d$.

For gauge theories with eight supercharges ($4d\mathcal{N} = 2$), Seiberg and Witten [32, 33] found a way to determine the low energy effective action and therefore the IR dynamics of these theories. A remarkable feature of their solution is the presence of massless monopoles or dyons. However these theories are not confining. We can reach confining ones by softly breaking $\mathcal{N} = 2$ SUSY to $\mathcal{N} = 1$ (technically it is done by giving a mass to the adjoint chiral field). By using the Seiberg-Witten solution, we can study this deformation and prove confinement. The upshot is that the magnetic monopoles condense which leads to the screening of the magnetic charges and confinement for the electric ones. It is the electro-magnetic (EM) dual of the Higgs mechanism that is responsible for the Meissner effect (confinement of the magnetic charges) taking place in superconductors. This is a concrete realization of an old idea by 't Hooft and Mandelstam that confinement in non-abelian gauge theories is associated to condensation of magnetic object [34–36].

Theories with four supercharges ($4d\mathcal{N} = 1$) are less constraint but still the IR dynamics can be determined in some cases. It is mainly due to the power of holomorphy [37–39] and was applied by Seiberg to obtain the IR dynamics of $4d\mathcal{N} = 1$ SQCD. For $SU(N)$ with F flavors³, Seiberg argues that the theory confines for $0 \leq F \leq \frac{3}{2}N$. The way the theory confines vary depending on F . Let us briefly state the results, we will come back to $SU(N)$ SQCD in Section 2.1.1. Nice lectures about this subject can be found in [40–42]

- For $F = 0$, we have $\mathcal{N} = 1$ super Yang-Mills (SYM) which enjoys strict confinement⁴ and

³A flavor corresponds to two chiral fields, one in the fundamental representation and one in the anti-fundamental of $SU(N)$.

⁴The word strict means that not only quarks are confined but also the chromoelectric field. It cannot spread out in space over regions larger than about Λ^{-1} (the dynamical scale) in radius. See [43] for a nice explanation of confinement and strict confinement.

generation of a mass gap.

- For $0 < F < N$, the theory does not properly exist because there is a runaway behavior. It means that there is not an absolute minimum, at finite distance in field space, of the non-perturbatively generated superpotential.
- For $F = N, N + 1$, the theory confines with charge screening and no mass gap. The asymptotic states are mesons and baryons. In the $F = N$ case, the origin of the moduli space is removed by a non-perturbatively generated constraint and therefore there is always a chiral symmetry breaking. This situation is referred to *quantum deformed moduli space*. Instead for $F = N + 1$, the origin is part of the moduli space and at this point the global symmetry is not spontaneously broken. This case is called *S-confinement*.
- For $N + 1 < F < \frac{3}{2}N$, the theory confines, the asymptotic states are still mesons and baryons (composite of the elementary electrically charged fields). However the surprising result of Seiberg is that the IR can also be described by freely interacting quarks and gluons magnetically charged under a gauge group that is not visible under the electric description of the theory. This phase is called the *free magnetic phase*. It is an instance of what is now called Seiberg duality. A concept that we will review shortly.
- For $F \geq \frac{3}{2}N$ the theory does not confine.

Let us expand on the *S-confinement* case because it will play an important role in this thesis. The S in *S-confinement* stands for *smooth*. More precisely this terminology has been introduced in [44] for “smooth confinement without chiral symmetry breaking and with a non-vanishing confining superpotential”. The IR behavior of an S-confining gauge theory, by definition, can be captured by a theory with trivial gauge dynamics, that is a Wess-Zumino (WZ) model. The elementary fields of the IR WZ description map with the gauge invariant operators of the UV gauge theory, more precisely they are in one-to-one correspondence with the generators of the chiral ring of the UV gauge theory. In addition, we require that this WZ description is valid everywhere on the moduli space including the origin where therefore all global symmetries are unbroken. The two paradigmatic, and simplest, examples of S-confining gauge theories are [37, 45]

- $SU(N)$ with $N + 1$ flavors, described by a theory of mesons and baryons.
- $USp(2N)$ with $N + 2$ flavors⁵, described by a theory of mesons.

There are also other examples of S-confining gauge theories. In particular, [46] classified all the S-confining gauge theories with a simple gauge group and vanishing tree-level superpotential. These theories were argued to be S-confining by proposing a WZ description and checking that all the 't Hooft anomalies of the UV gauge theory match the 't Hooft anomalies of the WZ description. We review this work in section 2.8.

⁵For USp gauge group, we call a flavor two chiral fields in the fundamental representation.

As anticipated in the last paragraph, duality is an important phenomenon and will be the main protagonist of this thesis. There are a lot of different situations than physicists regroup under the name of duality:

- Exact EM duality as in pure Maxwell theory (free $U(1)$ gauge theory) and the maximally supersymmetric theories $4d\mathcal{N} = 4$ SYM.
- $4d\mathcal{N} = 2$ S-dualities.
- Seiberg duality in $\mathcal{N} = 1$.
- Mirror symmetry in $3d$ and $2d^6$.
- UV duality in $5d$.
- Conformal dualities.
- Holographic duality (AdS/CFT).

Loosely speaking, we talk about duality for situations in which we have two (or more) apparently different theories which, however, agree when computing some physical quantities. We can either search for a proof of the duality statement, it is, however, an extremely rare situation when we can succeed, or we can more modestly gain confidence on the claim by performing non-trivial checks. A duality statement can be extremely useful because some physical quantities could be at strong coupling in one description (therefore impossible to compute usually) but at weak coupling in the dual frame (therefore accessible). We have already discussed one such example in the context of the free magnetic phase of $SU(N)$ SQCD. This is the power of duality [51] and what makes dualities among the most powerful tool to analyze QFT at strong coupling. There is another use of a duality statement worth stating. We can use a duality in order to define precisely one side when such clear definition does not exist. For example, in AdS/CFT we can use the clear CFT definition part in order to define what we mean by quantum gravity in AdS space.

The kind of dualities that will mainly talk about in this thesis is the Seiberg ones. A more proper definition is the following. A given CFT \mathcal{T}_A in the UV deformed by a relevant deformation flow in the IR to a theory that can be obtained starting from a different CFT \mathcal{T}_B and a relevant deformation. The first example [38] involves $SU(N)$ SCQD with F flavors for \mathcal{T}_A and \mathcal{T}_B is given by $SU(F - N)$ SQCD with F flavors (q_i, \tilde{q}^i) , F^2 gauge singlets M_j^i and superpotential $\mathcal{W} = q_i M_j^i \tilde{q}^j$. After this discovery by Seiberg, a lot of other examples have been found for other gauge group, matter content and superpotential [45, 52–67]. Up to now, we have talk about the situation in $4d$. However this kind of duality is not restricted to this dimension and examples have been found in $3d$ and $2d$ [68–79].

One of the main lines of research in this thesis has been to organize and find new dualities. By organizing, we have this specific meaning of which dualities are independent and which ones could be obtained by use of the independent ones. Another way of formulating the problem

⁶See [47–50] for a recent discussion of this class of duality in a $4d$ context.

would be, could we find a basis of dualities? This question is open and it is not clear that we have enough understanding of strong coupling dynamics to give a definitive answer. The best we can do for now is to prove as many dualities as possible among the ones that already exist in the literature. To be clear, by *proving the duality* between theory \mathcal{T}_1 and theory \mathcal{T}_k , we mean constructing a sequence of quiver gauge theories \mathcal{T}_i , $i = 1, \dots, k$, such that \mathcal{T}_i is related to \mathcal{T}_{i+1} by the application of an elementary duality on a single node. So all the theories $\mathcal{T}_1, \dots, \mathcal{T}_k$ are infrared dual. Assuming, as is standard, that the renormalization group flows commute with dualizing a single node, this amounts to a proof of the non-elementary duality $\mathcal{T}_1 \leftrightarrow \mathcal{T}_k$. The recent line of research in this direction is concerned with the derivation of dualities involving rank-two matter applying iteratively known more basic dualities involving gauge theories with fundamental matter, like Seiberg [38], Intriligator-Pouliot [45] in $4d$ and Aharony dualities [68] in $3d$. The strategy we are going to use goes under the name of *sequential deconfinement* [1–3, 58, 60, 63, 80–87].⁷ The idea is to use a confining duality with fundamental matter fields (the S-confining theories that we mentioned previously) to trade the rank-two field for a new gauge node. This gives a quiver gauge theory that can be further dualized using basic dualities so to reach the desired dual frame. In three dimensions, [82, 83] proved a $3d \mathcal{N} = 2$ S-confining duality for $U(N)$ with adjoint and $(1, 1)$ fundamentals [91–93] iterating Aharony duality. [85] proved $3d \mathcal{N} = 2$ self-dualities of $U(N)$ with adjoint and $(2, 2)$ fundamentals and of $USp(2N)$ with antisymmetric and 6 fundamentals [92, 93], iterating Aharony dualities. Iterative application of confining monopole dualities [94] have been proven very useful in $3d$ also in [80, 81, 95, 96]. In this thesis, we will see a proof of the S-confining dualities in the classification of [46] that we mentioned before. The dualities that we use as basic building blocks are the two S-confining dualities discussed above, that is $SU(N + 1)/USp(2N)$ with $N + 2$ flavors. Our strategy is similar to the strategy of [82, 83, 87], implemented in 3 dimensions.⁸ One immediate lesson that can be drawn from these results is that the basic Seiberg dualities, involving only fundamental matter, seem to be strong enough to prove dualities involving more general matter content. Recent results that corroborate this expectation appeared recently in [47–50] where a similar logic of the sequential deconfinement allowed to derive $4d$ and $3d$ mirror symmetry with eight and four supercharges from the Intriligator–Pouliot [45] and the Aharony duality [68], respectively. Interestingly, the deconfinement procedure also has an avatar in the math literature once implemented at the level of some supersymmetric partition function such as the $4d \mathcal{N} = 1$ supersymmetric index, see e.g. [24–27].

Another organizing principle to study QFT phenomena, that is going to play a role in this thesis, is the one of dimensional reduction. The idea of relating theories defining in different dimensions is old, the Kaluza-Klein (KK) original idea of unifying gravity and electromagnetism using a fifth dimension is more than 100 years old [99, 100]. After the intrusion of string theory inside theoretical physics, the study of compactification has received much more attention, see

⁷Similar deconfinements appear in [88, 89] in the study of orientifolded dimer models, and were used in [90] to construct $\mathcal{N} = 1$ Lagrangians for $4d \mathcal{N} = 2$ SCFTs.

⁸Indeed, dimensional reducing $USp(2N)$ with antisymmetric and 6 fundamentals on a circle and turning on appropriate real mass deformations as in [92, 94], it is possible to flow to the S-confining duality of $3d \mathcal{N} = 2$ $U(N)$ with adjoint and $(1, 1)$ fundamentals discussed in [82, 83]. See [97] for a study of $3d \mathcal{N} = 2$ S-confining single node quivers and [98] for a relation between $4d$ and $3d$ S-confinements.

[101] for a recent review and references therein. In more recent years, the idea of compactification has been used to study strong coupling effects like IR dualities in field theory without gravity. The schematic way dimensional reduction of a duality works is the following. We start with a pair of dual theory, \mathcal{T}_1 and \mathcal{T}_2 in d spacetime dimension. Then we compactify both of the dual theories in a $(d - d')$ -dimensional manifold (with characteristic length r) and flow to energy E much smaller than the compactification scale. We obtain two theories in d' spacetime dimension and we want to know if they are dual or not. In this process, two limits are involved: the compactification radius goes to 0 ($r \rightarrow 0$) and the flow to low energy ($E \rightarrow 0$). The subtlety is about the order of the two limits. First order: take first $E \rightarrow 0$ (r fixed) for T_1 and T_2 , this is the regime of validity of the duality in d dimension and therefore we reach the same fixed point theory \mathcal{T}_{IR} (still in d dimension). Taking then $r \rightarrow 0$ should correspond to the dimensional reduction of this fixed point and gives a theory \mathcal{T}'_{IR} living in d' dimension. Second order: take first $r \rightarrow 0$, we get two theories \mathcal{T}'_1 and \mathcal{T}'_2 in d' dimension. Then going to low energy $E \rightarrow 0$. If the two limits commute ($r \rightarrow 0$ and $E \rightarrow 0$) then the two theories \mathcal{T}'_1 and \mathcal{T}'_2 should flow in the IR to the same fixed point \mathcal{T}'_{IR} and therefore we obtain a duality statement in d' spacetime dimension. The study of the commutativity of the limits has been done in different setups. From $4d\mathcal{N} = 1$ to $3d\mathcal{N} = 2$ in [76, 102–106], from $3d\mathcal{N} = 2$ to $2d\mathcal{N} = (2, 2)$ in [107, 108] and from $4d\mathcal{N} = 1$ to $2d\mathcal{N} = (0, 2)$ in [109]. A lot of previously found $3d$ dualities have been linked to a $4d$ ancestor [68, 70, 110] and new ones have been discovered [92–94]. We will also present new $3d$ dualities in this thesis following this path. We could then ask the general question: do all dualities in $d \leq 3$ have a $4d$ ancestor? This is the same kind of open question than the previous one and once again it is not clear that we can give a definitive answer. The best we can do for now is to find a $4d$ ancestor to all the lower-dimensional IR dualities. Recently some progress has been made by finding a $4d$ ancestor to a class of IR dualities in $3d$ called mirror symmetry [47–50, 111].

Up to now, we have only talked about compactification when the starting theory is four-dimensional but a line of research starts with higher dimensional theories (5 or even $6d$). Let us first say few things about these theories. In 5 and $6d$ all Lagrangians are IR free so for a long time, it was not clear that non-trivial CFT existed in these dimensions. With the use of ST and supersymmetry people were able to show that indeed non-trivial SCFTs live at strong coupling of some gauge theories [112–114]. It has to be seen as a great success both for ST and SUSY. Up to now, clear existence of higher-dimensional theories has been established only for supersymmetric theories⁹.

$6d$ SCFTs are particularly appealing because it is the maximal dimension for which a superconformal algebra can be defined [122], SCFTs are either of the type $(2, 0)$ or $(1, 0)$ corresponding to 16 or 8 supercharges. The $(2, 0)$ theories are organized by an *ADE* classification [113, 123–126]. The $(1, 0)$ landscape is much wider. There exists a putative classification coming from ST (from F-theory, the non-perturbative completion of type IIB, to be more specific) [127–129], see [130] for a review.

The situation for the $5d\mathcal{N} = 1$ SCFTs (there is a unique superconformal algebra in $5d$) is more delicate and less understood. The most systematic approach so far has been to study

⁹Recent works have investigated non-supersymmetric fixed point in $5d$ [115–121].

$5d$ KK-theories meaning theories which UV complete in $6d$. Saying in another way, these are the theories that we get after compactifying $6d$ SCFTs on a circle (with possible twists of the global symmetries) [131–138]. It is conjectured that all $5d$ SCFTs can be obtained starting from the KK-theories and flowing from them by deformations (like mass deformation). It is an open problem understanding if this method gives a full classification or not. A recent review on the status of the classification, both for $6d$ and $5d$ SCFTs, can be found in [11]. It includes an exhaustive list of references.

Let us now cite some of the uses of these higher-dimensional theories in the study of lower-dimensional theories. One of the earliest and clearest uses of the $(2, 0)$ theory [139] was to give a geometric origin of the $SL(2, \mathbb{Z})$ self-duality of the $4d \mathcal{N} = 4$ SYM conjectured in [140, 141]. The reasoning goes as follows: compactify the $6d (2, 0)$ on a 2-torus T^2 to get the $4d \mathcal{N} = 4$ SYM (no supercharges are broken because T^2 is flat). The complex structure of T^2 is interpreted as the holomorphic gauge coupling of the $4d$ theory. Then S-duality ($\tau \rightarrow -\frac{1}{\tau}$) of the field theory comes from the invariance of the complex structure of T^2 under this transformation. Then the compactification of the $6d(2, 0)$ has been generalized to other Riemann surfaces with or without punctures. It leads to the construction of a huge class of $4d \mathcal{N} = 2$ SCFTs called class \mathcal{S} , see [142–144] for the original work, [145–164] for a lot of generalizations and [165] for a recent review. The compactification also allows to understand the origin of highly non-trivial duality transformation in $4d$. Indeed distinct $4d$ theories correspond to different pants decomposition of the same Riemann surface and therefore should be related by some S-duality (it is the case because we expect that the $4d$ theory depends only on the topology of the surface and therefore all pants decomposition are equivalent). More precisely, the deformation to get from one surface to the other is interpreted in field theory as moving in the parameter space that connects the two theories. Later, $4d \mathcal{N} = 1$ SCFTs have been obtained using similar philosophy. Starting once again with $6d(2, 0)$ theories but studying a compactification that preserves only $\mathcal{N} = 1$ in $4d$ [166–169]. An even larger class of $4d \mathcal{N} = 1$ theories can be generated by starting with $6d(1, 0)$ theories instead of the $(2, 0)$ [111, 170–177]. These results about compactification lead to the discovery of the notion of *across dimensions IR duality*. It is the search for a $4d$ Lagrangian that flows in the IR to the same SCFT has the one we get after compactifying a $6d$ theory on a surface. More precisely the statement that two theories are across dimension dual is the following: we have a $6d$ SCFT deformed by geometry and a $4d$ SCFT deformed by a relevant deformation that both flow to the same $4d$ SCFT in the IR. A recent review on this topic can be found in [178].

Another way of using ST to study aspects of field theory is to engineer them using D-branes. It is doable because the low energy dynamics of D-branes is described by SYM on their worldvolume. Since the original brane setup of Hanany-Witten [179] describing $3d \mathcal{N} = 4$ theories a lot of work have been done to construct gauge theories in several dimensions, with different amounts of SUSY and gauge groups. See [180] for a review. In the context of $5d \mathcal{N} = 1$ gauge theories, the Hanany-Witten brane setup [179], which in this case involve webs of 5-branes, a.k.a. pq-webs [181–183] is a powerful tool to analyze the strong coupling behavior. In many instances, there are more than one $5d$ gauge theories with the same infinite coupling SCFT. This SCFT can live either in $5d$ or $6d$ in the case of KK-theories. This phenomenon

goes under the name of *5d dualities*, even if the language is slightly improper, since the physical picture is really that the UV SCFT can be relevantly deformed in various different ways, triggering RG flows to different IR gauge theories. Pq-webs were used to study *5d* dualities in [184–187]. Later, the pq-web technology to deal with KK-theories was developed: [188–193] discuss many examples of different *5d* $\mathcal{N} = 1$ quiver gauge theories with the same *6d* SCFT in the infinite coupling limit, described by Type IIA brane systems [194–196].

Inspired by these ideas, we will present in this thesis an interplay between *5d* KK-theories and *4d* $\mathcal{N} = 1$ theories. More precisely, the interplay consists of a prescription to construct *4d* $\mathcal{N} = 1$ dualities associated to *5d* KK dualities. Starting from a *5d* KK quiver with 8 supercharges, the *4d* quivers has the same gauge structure (but in *4d* the nodes are $\mathcal{N} = 1$ 4 supercharges nodes), the same matter fields (but in *4d* there are chiral multiplets instead of hyper multiplets) plus for each bifundamental we add a "triangle". A "triangle" means that if in *5d* there is a bifundamental hyper connecting node A with node B , in *4d* there is a chiral bifundamental going from node A to node B , a fundamental going from node B to a global $SU(2)$ node, and a fundamental going from the global $SU(2)$ node to node A . We also add a cubic $SU(2)$ invariant superpotential term. Such triangles are meant to reproduce the *5d* axial symmetries (which are anomalous in *4d* but not in *5d*) and the *5d* instantonic symmetries (which do not exist in *4d*). With this prescription we are able to associate a *4d* quiver to *5d* quivers, in such a way that the rank of the global *4d* symmetry is equal to the rank of the global *5d* symmetry minus 2. We only consider quivers such that this prescription yields a *4d* quivers without gauge anomalies. The claim is that the two *4d* quivers constructed with the above prescription are IR dual. A comment has to be made. We don't have a clear understanding of the prescription that we gave. It is an interesting observation that leads to non-trivial dualities but the reason why it is working is lacking. More precisely, the connection with the story of compactification from *6d* (found the geometry, fluxes, etc) remain to be discovered. It is an interesting open problem.

Another interesting strong coupling phenomenon is the symmetry enhancement. It is the idea that the symmetry group at the end of the RG flow is bigger than the one in the UV. The intuitive explanation of the symmetry enhancement is that some d.o.f that were breaking some global symmetry decoupled along the RG flow. Duality can sometimes help to spot symmetry enhancements. Indeed it is possible that in some duality frame, the IR symmetry group is manifest but not in the other. Let us see one of the simplest instances. Let us take the original example of Seiberg duality in the specific case of $N = 2$ and generic number of flavor F . Since the fundamental representation of $SU(2)$ is pseudoreal, there is no distinction between the fundamental and the anti-fundamental and therefore the global symmetry does not involve $SU(F) \times SU(F)$ but it contains $SU(2F)$. Now if we look at the dual theory, we have an $SU(F - 2)$ gauge theory with F flavors, F^2 singlets and a non-vanishing superpotential. In this case the gauge group is complex therefore there is a distinction between the fundamental and anti-fundamental representation so the symmetry group involves $SU(F) \times SU(F)$. The duality teaches us that for the dual theory there should be an enhancement of the global symmetry in the IR. Another situation where symmetry enhancement and duality are linked is the case of exactly self-dual theories. Usually it goes as follows. We start with a *self-dual modulo flips*

statement. By this we mean that the electric and magnetic theory share the same gauge structure, but differ by gauge singlets fields that are called flippers. Self-dualities modulo flips have been discussed in [64, 65, 197, 198], the simplest case is $SU(2)$ with 8 doublets. Interestingly, given a self-duality modulo flips, it is possible to move the singlets across the duality and construct *exactly self-dual theories*. In this case the duality becomes a true symmetry that leads to enhanced IR global symmetry, see for instance [177, 198–201]. In particular, [201] studied the $4d \mathcal{N} = 1$ $USp(2N)$ gauge theory with antisymmetric and 8 fundamentals. This theory has been proposed to be *self-duality modulo flips* long time ago in [65] (in this thesis we will present a proof, in the sense discussed previously, of this statement). Then, [201] constructed various exactly self-dual theories and discussed the associated symmetry enhancements. Symmetry enhancement can sometimes also be understood when a higher dimensional of the theory is known, in particular compactifying a $6d$ $(1, 0)$ SCFT on a Riemann surface. For $USp(2N)$ with antisymmetric and 8 fundamentals, [177] related the self-duality and specific symmetry enhancements to a compactification of the rank- N E-string $6d$ SCFT on a 2-sphere.

In this thesis, we will see another type of enhancement where what gets enhanced is the supersymmetry group. We talk about *supersymmetry enhancement*. During recent years, research in the area of four-dimensional theories with minimal supersymmetry, $4d \mathcal{N} = 1$, provided us with various instances of this phenomenon: $\mathcal{N} = 1$ theories which flow at strong coupling to superconformal fields theories (SCFTs) with $\mathcal{N} = 2, 3, 4$ supersymmetry [80, 90, 95, 96, 202–213]. More precisely, $\mathcal{N} \geq 2$ theories might possess a conformal manifold¹⁰ of $\mathcal{N} = 1$ exactly marginal deformations and one might be able to reach a point of this conformal manifold via RG flow of some other $4d \mathcal{N} = 1$ UV theory. This idea of SUSY enhancement was used in [204] to give Lagrangian to "non-Lagrangian" theories like Argyres-Douglas theories¹¹. This was useful because using this Lagrangian it was possible to compute protected quantities like the superconformal index of some of these strongly coupled theories.

We now summarize the contents of the thesis. In Chapter 2 we review all the facts about $4d \mathcal{N} = 1$ and $3d \mathcal{N} = 2$ that we will need in the rest of the thesis. It includes among other things a discussion about a -maximization, Seiberg-like dualities in $4d$ and $3d$, the classification of the single gauge node S-confining theories.

In Chapter 3 we start by proving all S-confining dualities presented in Chapter 2 that involve matter in rank-1 and/or rank-2 representations. The set of theories includes 3 infinite series: $USp(2N)$ with antisymmetric and 3 flavors, $SU(N)$ with antisymmetric and $(4, N)$ flavors, $SU(N)$ with antisymmetric, conjugate antisymmetric and $(3, 3)$ flavors. Moreover there are 4 exceptional cases, with $SU(5), SU(6), SU(7)$ gauge group and 2 or 3 antisymmetric fields plus flavors. Then we present the general sequential deconfinement of $USp(2N)$ with an antisymmetric and $2F$ fundamentals. We use this result to prove the self-duality of the theory when $F = 4$. We finish this Chapter by showing how to reduce our $4d \mathcal{N} = 1$ $USp(2N)$ story to $3d \mathcal{N} = 2$, re-obtaining the results of for $U(N)$ and $USp(2N)$ found in [85]. Along the way we also derive new sequentially deconfined duals, namely for $U(N)$ with adjoint and (F, F)

¹⁰The conformal manifold is the space of exactly marginal deformations meaning deformation of the CFT by an operator whose scaling dimension is equal to the spacetime dimension d .

¹¹Argyres-Douglas are strongly coupled $4d \mathcal{N} = 2$ theories which contain fractional scaling dimensions.

fundamentals with monopole superpotentials.

In Chapter 4 we present in detail the prescription to build $4d \mathcal{N} = 1$ dualities starting from $5d$ KK dualities. Then the rest of the Chapter is devoted to test the prescription. We discuss two classes of theories that we call $R_{N,k}$ and $A_{n,m}$. In the case of $R_{N,k}$, we are able to prove the $4d \mathcal{N} = 1$ dualities in the same way we did in Chapter 3. For the second class, $A_{n,m}$, we do not have such a proof and the proposed dualities are tested by matching the 't Hooft anomalies and the central charges.

In Chapter 5 we start by proposing new S-confining theories, with simple gauge group and cubic superpotential. In the case of $USp(2n)$ gauge group and $\mathcal{W} \sim app$, we discuss the reduction on a circle, which upon turning on appropriate real masses, leads to a $3d U(n)$ gauge theory with $2n+1$ flavors and a monopole superpotential which is dual to an adjoint field Φ with cubic superpotential. We derive some of the previously stated dualities, using deconfinement techniques and/or Kutasov–Schwimmer-like dualities. Then we turn to the study of various $4d \mathcal{N} = 1$ theories with SUSY enhancement. We show that the new $3d$ S-confining duality that we obtained helps to understand some SUSY enhancements. Specifically, we provide a $3d$ explanation of the SUSY enhancement of the theory proposed in [213], that is a $\mathcal{N} = 1$ $SU(2n+1)$ gauging of three copies of the $\mathcal{N} = 2$ theory $D_2(SU(2n+1))$ of [158, 162, 214] which flows to a point of the conformal manifold of $4d \mathcal{N} = 4$ SYM with gauge group $SU(2n+1)$. Based on the $3d$ understanding of this case, we are then able to generalize it and give as a new example the $\mathcal{N} = 1$ $SU(2n+1)^3$ gauging of a single copy of the $\mathcal{N} = 2$ $D_2(SU(6n+3))$ theory which flows on the conformal manifold of the $4d \mathcal{N} = 2$ necklace quiver with three $SU(2n+1)^3$ gauge group.

Chapter 2

Basics of supersymmetric quiver gauge theories

2.1 Quick review of $4d\mathcal{N} = 1$ and $3d\mathcal{N} = 2$ theories

2.1.1 $4d\mathcal{N} = 1$ basics:

In this subsection, we review briefly the main important aspects of minimal SUSY theories in $4d$. The main references are [40–42]. We follow, in particular [42].

$4d\mathcal{N} = 1$ superalgebra:

The starting point is the superalgebra. As reviewed in the introduction, the concept of superalgebra provides a generalization of the no-go theorem of Coleman and Mandula. Superalgebra allows enlarging the Poincaré group by adding fermionic generators Q_α to the standard bosonic ones. In $4d$, the minimal number of supercharges is four: $Q_\alpha, \bar{Q}_{\dot{\beta}}$ where $\alpha, \dot{\beta} = 1, 2$ are spinorial indices associated to the presentations $(\frac{1}{2}, 0)$ and $(0, \frac{1}{2})$ of the Lorentz group. The $4d\mathcal{N} = 1$ superalgebra is the following

$$\begin{aligned} \{Q_\alpha, \bar{Q}_{\dot{\beta}}\} &= 2\sigma_{\alpha\dot{\beta}}^\mu P_\mu \\ \{Q_\alpha, Q_\beta\} &= 0 = \{\bar{Q}_{\dot{\alpha}}, \bar{Q}_{\dot{\beta}}\} \\ [P_\mu, Q_\alpha] &= 0 = [P_\mu, \bar{Q}_{\dot{\beta}}] \\ [M_{\mu\nu}, Q_\alpha] &= i(\sigma_{\mu\nu})_\alpha^\beta Q_\beta \\ [M_{\mu\nu}, \bar{Q}_{\dot{\alpha}}] &= i(\bar{\sigma}_{\mu\nu})_{\dot{\alpha}}^{\dot{\beta}} \bar{Q}_{\dot{\beta}} \end{aligned} \tag{2.1}$$

where $\sigma_{\mu\nu} = \frac{1}{4}[\sigma_\mu, \sigma_\nu]$, $\sigma_\mu = (I, \sigma_i)$, $\bar{\sigma}_\nu = (I, -\sigma_i)$ and σ_i are the Pauli matrices. When studying supersymmetry it is extremely useful to introduce the notion of superspace. It is a space spanned by the coordinates $(x^\mu, \theta^\alpha, \bar{\theta}^{\dot{\alpha}})$ where $\theta^\alpha, \bar{\theta}^{\dot{\alpha}}$ are fermionic coordinates. In this space, we can define the following covariant derivatives

$$\begin{aligned} D_\alpha &= \partial_\alpha + i\sigma_{\alpha\dot{\beta}}^\mu \bar{\theta}^{\dot{\beta}} \partial_\mu \\ \bar{D}_{\dot{\alpha}} &= \bar{\partial}_{\dot{\alpha}} + i\theta^\beta \sigma_{\beta\dot{\alpha}}^\mu \partial_\mu \end{aligned} \tag{2.2}$$

where $\partial_\alpha, \bar{\partial}_{\dot{\alpha}}$ are the derivatives corresponding to the fermionic coordinates.

The next step is to introduce *superfields*. A superfield is simply a function on superspace. We use these superfields in order to study representation theory of the superalgebra. Since the superalgebra contains the Poincaré algebra as a subalgebra, we can write any superfield in terms of standard component fields. Now let us review the most important multiplets.

SUSY multiplets:

Chiral multiplet Φ : It is a superfield defined by

$$\bar{D}_{\dot{\alpha}}\Phi = 0 \quad (2.3)$$

Φ is composed of

$$\Phi = (\phi, \psi, F) \quad (2.4)$$

where ϕ is a complex scalar field, ψ is a chiral fermion and F is a scalar field that does not propagate and it is thus called auxiliary.

Vector multiplet V : It is a superfield defined by the reality condition

$$V = \bar{V} \quad (2.5)$$

V is composed of

$$V = (A_\mu, \lambda, D) \quad (2.6)$$

where A_μ is a vector field, λ is a chiral fermion and D is an auxiliary real field as F .

Using the vector multiplet, we can build a chiral field that is called the gauge-covariant field strength. It is defined by

$$W_\alpha = -\frac{1}{4}\bar{D}^{\dot{\beta}}\bar{D}_{\dot{\beta}}e^{-V}D_\alpha e^V \quad (2.7)$$

It is a key element to construct SUSY Lagrangians. Before, let us recall the gauge transformations on the previously defined superfields.

Gauge transformations:

In superspace formalism, gauge transformations are parametrized by a chiral superfield Λ . If the gauge group G is non-abelian, quantities become matrix valued like $\Lambda = \Lambda_I T^I$ with $I = 1, \dots, \dim G$ and T^I the generators of the gauge group. Under gauge transformations, the chiral field Φ , the vector field V , the exponential of the vector field e^V and the gauge-covariant field strength W_α transform as

$$\Phi \rightarrow e^{-i\Lambda} \Phi \quad (2.8)$$

$$V \rightarrow V + \Lambda + \bar{\Lambda} \quad (2.9)$$

$$e^V \rightarrow e^{-i\bar{\Lambda}} e^V e^{i\Lambda} \quad (2.10)$$

$$W_\alpha \rightarrow e^{-i\Lambda} W_\alpha e^{i\Lambda} \quad (2.11)$$

SUSY Lagrangians:

Using the previous ingredients and the fact that θ has dimension $-1/2$, chiral superfields have dimension 1 and vector superfields dimension 0 we can write down SUSY Lagrangians. The first piece is the gauge part of the Lagrangian

$$\mathcal{L}_{gauge} = \frac{-i}{64\pi} \int d^2\theta \sum_a \tau^{(a)} \text{Tr} (W^{(a)\alpha} W_\alpha^{(a)}) + \text{h.c} \quad (2.12)$$

$$= \frac{1}{32\pi} \text{Im} \left(\int d^2\theta \sum_a \tau^{(a)} \text{Tr} (W^{(a)\alpha} W_\alpha^{(a)}) \right) \quad (2.13)$$

The sum is over the number of factors in the gauge group $G = \sum_a G_a$ and the complexified gauge coupling $\tau^{(a)}$ associated to each gauge factor G_a is defined by

$$\tau^{(a)} = \frac{\theta_{YM}^{(a)}}{2\pi} + \frac{4\pi i}{g^{(a)2}} \quad (2.14)$$

The second piece involves the chiral superfields and describe the matter content of the SUSY theory. The Lagrangian is given by

$$\mathcal{L}_{matter} = \int d^2\theta d^2\bar{\theta} \sum_i (\bar{\Phi}^i e^V \Phi^i) + \int d^2\theta \mathcal{W}(\Phi^i) + \int d^2\bar{\theta} \bar{\mathcal{W}}(\bar{\Phi}^i) \quad (2.15)$$

The sum runs over the matter chiral multiplets Φ_i and V is in a representation that is appropriate for the field Φ_i . The function \mathcal{W} is holomorphic in Φ_i and is called the superpotential.

In case G has some $U(1)$ factors, we can include another term called Fayet-Illiopoulos (FI)

$$\mathcal{L}_{FI} = \sum_A \xi_A \int d^2\theta d^2\bar{\theta} V^A \quad (2.16)$$

The sum is over the $U(1)$ factors. The FI parameters are real.

The full Lagrangian, in the holomorphic scheme where the gauge coupling appears only in the complex parameter $\tau^{(a)}$, is given by the sum of (2.13), (2.15) and (2.16)

$$\mathcal{L} = \mathcal{L}_{gauge} + \mathcal{L}_{matter} + \mathcal{L}_{FI} \quad (2.17)$$

$$= \frac{1}{32\pi} \text{Im} \left(\int d^2\theta \sum_a \tau^{(a)} \text{Tr} (W^{(a)\alpha} W_\alpha^{(a)}) \right) + \sum_A \xi_A \int d^2\theta d^2\bar{\theta} V^A \\ + \int d^2\theta d^2\bar{\theta} \bar{\Phi}^i e^{\sum_a V^{(a)}} \Phi^i + \int d^2\theta \mathcal{W}(\Phi^i) + \int d^2\bar{\theta} \bar{\mathcal{W}}(\bar{\Phi}^i) \quad (2.18)$$

In order to go to the scheme that gives canonical gauge kinetic terms, we have to do the following rescaling in the vector superfield

$$V \rightarrow 2gV \quad (2.19)$$

This rescaling seems innocuous but the important point is that in this scheme the Lagrangian is *not* holomorphic in the combination appearing in (2.14). This fact has consequences on the renormalization property of the gauge coupling. See [215] for a beautiful discussion. In the

canonical scheme and in component fields (also suppressing the index a for clarity) the full Lagrangian reads

$$\begin{aligned}
\mathcal{L} = & \text{Tr} \left[-\frac{1}{4} F_{\mu\nu} F^{\mu\nu} - i\lambda\sigma^\mu D_\mu \bar{\lambda} + \frac{1}{2} D^2 \right] + \frac{\theta_{\text{YM}}}{32\pi^2} g^2 \text{Tr} F_{\mu\nu} \tilde{F}^{\mu\nu} + g \sum_A \xi_A D^A \\
& + (\overline{D_\mu \phi}) D^\mu \phi - i\psi\sigma^\mu D_\mu \bar{\psi} + \overline{F} F + i\sqrt{2}g\bar{\phi}\lambda\psi - i\sqrt{2}g\psi\bar{\lambda}\phi + g\bar{\phi}D\phi \\
& - \frac{\partial\mathcal{W}}{\partial\phi^i} F^i - \frac{\partial\overline{\mathcal{W}}}{\partial\bar{\phi}_i} \bar{F}^i - \frac{1}{2} \frac{\partial^2\mathcal{W}}{\partial\phi^i\partial\phi^j} \psi^i\psi^j - \frac{1}{2} \frac{\partial^2\overline{\mathcal{W}}}{\partial\bar{\phi}_i\partial\bar{\phi}_j} \bar{\psi}_i\bar{\psi}_j
\end{aligned} \tag{2.20}$$

Where $\tilde{F}^{\mu\nu} = \frac{1}{2}\varepsilon^{\mu\nu\rho\sigma}F_{\rho\sigma}$ is the dual field strength. We can also integrate out the auxiliary fields F and D . Their equations of motion are given by

$$F^i = \frac{\partial\overline{\mathcal{W}}}{\partial\bar{\phi}_i}, \quad D^I = -g\bar{\phi}T^I\phi - g\xi^I \tag{2.21}$$

With $\xi^I = 0$ if $I \neq A$. Plugging back into (2.18), we get the on-shell Lagrangian

$$\begin{aligned}
\mathcal{L} = & \text{Tr} \left[-\frac{1}{4} F_{\mu\nu} F^{\mu\nu} - i\lambda\sigma^\mu D_\mu \bar{\lambda} \right] + \frac{\theta_{\text{YM}}}{32\pi^2} g^2 \text{Tr} F_{\mu\nu} \tilde{F}^{\mu\nu} + (\overline{D_\mu \phi}) D^\mu \phi - i\psi\sigma^\mu D_\mu \bar{\psi} \\
& + i\sqrt{2}g\bar{\phi}\lambda\psi - i\sqrt{2}g\psi\bar{\lambda}\phi - \frac{1}{2} \frac{\partial^2\mathcal{W}}{\partial\phi^i\partial\phi^j} \psi^i\psi^j - \frac{1}{2} \frac{\partial^2\overline{\mathcal{W}}}{\partial\bar{\phi}_i\partial\bar{\phi}_j} \bar{\psi}_i\bar{\psi}_j - V(\phi, \bar{\phi})
\end{aligned} \tag{2.22}$$

And the scalar potential $V(\phi, \bar{\phi})$ is

$$V(\phi, \bar{\phi}) = \frac{\partial\mathcal{W}}{\partial\phi^i} \frac{\partial\overline{\mathcal{W}}}{\partial\bar{\phi}_i} + \frac{g^2}{2} \sum_{I=1}^{\dim(G)} |\bar{\phi}T^I\phi + \xi^I|^2 = F\bar{F} + \frac{1}{2}D^2 \Big|_{\text{on-shell}} \tag{2.23}$$

Moduli space:

The scalar potential (2.23) is a semi-positive definite quantity. Hence, the supersymmetric vacua are those field configurations on which the scalar potential vanishes or, in other words, those that solve the so-called F-term and D-term equations

$$\bar{F}_i(\phi) = 0, \quad D^I(\phi, \bar{\phi}) = 0 \tag{2.24}$$

The space of scalar field VEVs that satisfied (2.24) is called the classical *moduli space*. The moduli space of inequivalent vacua is the set of all zero-energy field configurations modulo gauge transformations. It exists another useful formulation of the moduli space [216]. It could be described as the space spanned by all gauge invariant operator VEVs made out of scalar fields, modulo classical relations and constraints coming from the F-term equations (see a further discussion in section 2.2). Up to now the discussion of the moduli space was only classical. In general, some vacua can be lifted by quantum corrections modifying the classical picture. However due to non-renormalization properties the only way to lift a classical supersymmetric vacuum are non-perturbative corrections. It is in huge contrast with non-SUSY theories in which a classically flat direction is generically lifted by radiative corrections in a form of the Coleman-Weinberg potential.

R-symmetry:

Supersymmetric theories have global symmetry which rotate the supercharges. It is called the *R-symmetry*. For $4d\mathcal{N} = 1$, the R-symmetry group is $U(1)_R$. The defining feature of the R-symmetry is the following action on the fermionic coordinates:

$$\theta \rightarrow e^{i\alpha}\theta \quad \bar{\theta} \rightarrow e^{-i\alpha}\bar{\theta} \quad (2.25)$$

with α the transformation parameter. It means that θ and $\bar{\theta}$ have R-charges 1 and -1 . Since θ and $\bar{\theta}$ have non-trivial R-charges, the different component fields within a superfield carry different R-charges. Once we talk about the R-charge of a superfield we refer to the R-charge of the lowest component. The R-charge of a product of superfields is the sum of the individual charges of the fields. The vector superfield V has R-charge 0 and the chiral field Φ has R-charge r_Φ . We collect the R-charges of the different quantities in Table 2.1

	θ	$\bar{\theta}$	$d^2\theta$	D_α	W_α	A^μ	λ	D	\mathcal{W}	ϕ	ψ	F
r	1	-1	-2	-1	1	0	1	0	2	r_Φ	$r_\Phi - 1$	$r_\Phi - 2$

Table 2.1: $U(1)_R$ R-charges of the different quantities.

All Lagrangian terms in (2.18) involving the gauge superfields are automatically R-symmetric. The term that needs to be checked is the one involving the superpotential. In order for the theory to conserve R-symmetry, the superpotential must carry R-charge 2.

$SU(N)$ SQCD:

In this subsection, we present briefly the analysis of SQCD with $SU(N)$ gauge group. The theory consists of a vector multiplet in the adjoint representation of $SU(N)$ and F flavors which mean F pairs of chiral multiplets Q_i respectively \tilde{Q}^i in the fundamental respectively antifundamental representation of $SU(N)$. There is no superpotential. At the quantum level, the global symmetry of the theory is

$$G_{SQCD} = SU(F)_Q \times SU(F)_{\tilde{Q}} \times U(1)_B \times U(1)_R \quad (2.26)$$

Classically there is another $U(1)$ symmetry called axial but it is anomalous (see the discussion in section 2.4). The quantum numbers of the fields are the following

	$SU(F)_Q$	$SU(F)_{\tilde{Q}}$	$U(1)_B$	$U(1)_R$
Q_i	$\bar{\mathbf{F}}$	$\mathbf{1}$	1	$\frac{F-N}{F}$
\tilde{Q}^i	$\mathbf{1}$	\mathbf{F}	-1	$\frac{F-N}{F}$
V	$\mathbf{1}$	$\mathbf{1}$	0	0

Table 2.2: Quantum numbers of $SU(N)$ SQCD.

Classically, the moduli space is parametrized by the meson matrix

$$M_i^j = Q_i^a \tilde{Q}_a^j \quad (2.27)$$

The index a corresponds to the gauge index. The meson matrix transforms in the bifundamental representation of the $SU(F)_Q \times SU(F)_{\tilde{Q}}$ global symmetry. When $F \geq N$, we have to add baryons

$$B_{i_1 \dots i_N} \equiv Q^N = Q_{i_1}^{a_1} \dots Q_{i_N}^{a_N} \varepsilon_{a_1 \dots a_N} \quad (2.28)$$

$$\tilde{B}^{i_1 \dots i_N} \equiv \tilde{Q}^N = \tilde{Q}_{a_1}^{i_1} \dots \tilde{Q}_{a_N}^{i_N} \varepsilon^{a_1 \dots a_N} \quad (2.29)$$

These generators are not independent because there exist non-trivial constraints relating the meson matrix and the baryons. For example, in the case $F = N$ the constraint is

$$\det M - B \tilde{B} = 0 \quad (2.30)$$

This classical moduli space \mathcal{M}_{cl} receives quantum correction. As we recall in the introduction, for $F < N$ a non-perturbative potential is generated and completely lifts \mathcal{M}_{cl} . Therefore the quantum theory has no supersymmetric vacuum.

For $F = N$, \mathcal{M}_{cl} is modified but is not completely lifted. In particular the constraint (2.30) is modified. The origin is now excluded which leads to chiral symmetry breaking.

The $F = N + 1$ case is the S-confinement situation invoked in the introduction and discussed more in section 2.6.1. In this case the quantum moduli space includes the origin.

For $F \geq N + 2$ the quantum moduli space is identical to the classical one. To determine what is the IR phase of the gauge theory, it is necessary to look at the behavior of the β -function of the gauge coupling. For a generic gauge theory, the one loop β -function is given by

$$\beta_g = \mu \frac{dg}{d\mu} = -\frac{b_1}{16\pi^2} g^3 \quad (2.31)$$

The one loop coefficient b_1 can be expressed compactly for supersymmetric $4d\mathcal{N} = 1$ theory as

$$b_1 = 3\mu(\text{adjoint}) - \sum_i \mu(\mathbf{r}_i) \quad (2.32)$$

where the sum is over all the chiral multiplets, $\mu(\mathbf{r})$ is the Dynkin index of the representation \mathbf{r} (see section 2.4 for the value of the Dynkin index of the principal representations). In the particular case of $SU(N)$ SQCD (2.32) gives

$$b_1 = 3N - F \quad (2.33)$$

We can immediately conclude that for $F \geq 3N$, the β -function (2.31) changes sign and SQCD is no longer asymptotically free. Therefore the gauge coupling decreases in the IR. The potential between external electric sources behaves like $V(R) \sim 1/(R \log(R\Lambda))$. This phase is called *non-Abelian free electric phase*.

We already said that due to non-perturbative effects there is no supersymmetric vacuum in the case $F < N$. This is called a *runaway* behavior.

The breakthrough of Seiberg was to give the IR behavior in the range $N \leq F \leq 3N$. As already said multiple times, for $F = N, N + 1$ the theory is confining with or without chiral symmetry breaking.

For $\frac{3N}{2} < F < 3N$ the theory reaches a stable non-trivial fixed point in the IR. The theory in the IR is therefore a SCFT. Quarks and gluons are not confined but are interacting massless particles. The potential behaves like $V(R) \sim 1/R$. This phase is called *non-Abelian Coulomb phase* and this range is called the *conformal window*. The upper bound can be understood from the change of sign of (2.31). The lower bound can be argued by studying operator dimensions.

For $N + 2 \leq F \leq \frac{3N}{2}$, the theory becomes infinitely coupled in the IR. As anticipated in the introduction, Seiberg found a new set of d.o.f to describe the IR. We will show this new description in section 2.6.1. This phase is called *non-Abelian free magnetic phase*.

2.1.2 $3d\mathcal{N} = 2$ basics:

We now turn on a quick review of the $3d\mathcal{N} = 2$ theories. They share many common properties with the $4d\mathcal{N} = 1$ ones because they have the same number of supercharges. In $3d$ they are not the minimally supersymmetric theories because it exists $3d\mathcal{N} = 1$. However $3d\mathcal{N} = 1$ theories have no holomorphy properties and therefore the dynamic is less constraint. This section is based on [217–219].

$3d\mathcal{N} = 2$ superalgebra:

The starting point is once again the superalgebra. It is obtained by dimensional reduction of the $4d\mathcal{N} = 1$ one. In particular, we have the following important relations

$$\begin{aligned} \{Q_\alpha, \bar{Q}_\beta\} &= 2\sigma_{\alpha\beta}^i P_i + 2i \varepsilon_{\alpha\beta} Z \\ \{Q_\alpha, Q_\beta\} &= 0 = \{\bar{Q}_\alpha, \bar{Q}_\beta\} \end{aligned} \tag{2.34}$$

The index i run from 0 to 2. The central term Z is given by the P_3 component in $4d$. Also in $3d$ we use the superspace formalism. The definition of the covariant derivatives (2.2) is the same. As in $4d$, the R-symmetry compatible with supersymmetry is $U(1)_R$. Now, we review the principal supermultiplets

SUSY multiplets:

Chiral multiplet Q : It is a superfield defined, as in $4d$, by $\bar{D}_\alpha Q = 0$. In components, Q is composed of the same fields

$$Q = (\phi, \psi, F) \tag{2.35}$$

with ϕ is a complex scalar, a 2-component complex fermion ψ and an auxiliary scalar field F .

Vector multiplet V : It is a superfield defined, as in $4d$, by $V = \bar{V}$. In terms of component fields, V is formed by

$$V = (\sigma, A_i, \lambda, D) \tag{2.36}$$

There is an important difference with the $4d$ vector multiplet. There are still a 2-component complex fermion λ , a $3d$ gauge field and an auxiliary scalar D , but there is an additional real scalar field σ . It corresponds to the component of the $4d$ gauge field in the reduced direction.

As usual, the vector superfield transforms in the adjoint representation of the gauge group. The real scalar field σ offers a new possibility, not present in $4d$. It can acquire a VEV that breaks the gauge group to its maximal Abelian torus, leading to a Coulomb branch of the moduli space. There is another multiplet that we introduce in $3d$

Linear multiplet¹ Σ : It is a real superfield defined by

$$\bar{\Sigma} = \Sigma \quad \text{and} \quad \varepsilon^{\alpha\beta} D_\alpha D_\beta \Sigma = \varepsilon^{\alpha\beta} \bar{D}_\alpha \bar{D}_\beta \Sigma = 0 \quad (2.37)$$

In components, we found inside Σ

$$\Sigma = (\sigma, j_i, \lambda, D) \quad (2.38)$$

with the bottom component σ a real scalar field.

Now let us make some important comments. When the gauge group is Abelian, the photon A_i can be dualized into a scalar γ via

$$\partial_i \gamma = \frac{\pi}{e_3^2} \varepsilon_{ijk} F^{jk} \quad (2.39)$$

where e_3 is the gauge coupling, F^{jk} is the field strength of A_i . Due to charge quantization, the *dual photon* is periodic $\gamma \sim \gamma + 2\pi$. We can associate a global $U(1)$ symmetry that corresponds to the shift of the dual photon. This symmetry is called topological and denoted $U(1)_J$. The conserved current associated to this symmetry is given by

$$J_i = \varepsilon_{ijk} F^{jk} \quad (2.40)$$

The conservation of the current (2.40) is due to Maxwell's equations.

Starting from a vector multiplet, we can build the standard chiral field strength W_α that, we also have in $4d$ (2.7) (it is working both for abelian and non-abelian gauge group). In the abelian case, we can also construct a linear multiplet as follow

$$\Sigma = -\frac{i}{2} \varepsilon^{\alpha\beta} \bar{D}_\alpha D_\beta V \quad (2.41)$$

This linear multiplet is gauge invariant. The bottom scalar field is the real scalar field σ of the vector multiplet and it contains the conserved current (2.40).

Last comment we want to make concerns the dual photon γ (2.39). It can be combined with the real scalar σ of the vector multiplet (or equivalently the linear multiplet) to form a complex scalar

$$\phi = \frac{2\pi}{e_3^2} \sigma + i\gamma \quad (2.42)$$

This complex scalar ϕ is the bottom component of a chiral superfield Γ that corresponds to the dual of the vector multiplet V .

What we describe concerning the dual photon is true only when the gauge group is Abelian. In the non-Abelian case, there is no known way to dualize the gauge fields into scalars. Therefore there is no $U(1)_J$ global symmetry in this case.

¹This multiplet also exists in $4d$. It is to embed conserved currents.

SUSY Lagrangians:

We have collected all the ingredients to write down $3d\mathcal{N} = 2$ invariant Lagrangians. We recall that in $3d$, the fermionic coordinate θ has dimension $-\frac{1}{2}$, chiral superfields have dimension $1/2$ and vector superfields have dimension 0. The first term is similar to (2.12)

$$\mathcal{L}_{gauge} = \frac{1}{e_3^2} \int d^2\theta \text{Tr} (W^\alpha W_\alpha) + \text{h.c} \quad (2.43)$$

In $3d$, there is no theta angle. So there is no complexified gauge coupling.

The second piece is the matter part. It is the same as (2.15)

$$\mathcal{L}_{matter} = \int d^2\theta d^2\bar{\theta} \sum_i (\bar{Q}^i e^V Q^i) + \int d^2\theta \mathcal{W}(Q^i) + \int d^2\bar{\theta} \bar{\mathcal{W}}(\bar{Q}^i) \quad (2.44)$$

The superpotential is still a holomorphic function of the chiral superfields. It has still an R-charge equal to 2 but a dimension equal to 2 because we are in $3d$. An important term inside (2.44) is the following

$$\sum_i |\sigma Q_i|^2 \quad (2.45)$$

we see that a VEV of the scalar field σ will give a mass to the chiral superfields. Since σ is real, it is called a real mass.

If the gauge group contains $U(1)$ factors we can introduce FI parameters as in (2.16). Let us give a motivation for this term. When we have a global symmetry, we can couple our theory to a corresponding background vector superfield V_b . We introduce the following term that preserves SUSY and called BF term

$$\mathcal{L}_{BF} = \int d^2\theta d^2\bar{\theta} V_b \Sigma = \int d^2\theta d^2\bar{\theta} \Sigma_b V \quad (2.46)$$

to obtain the second equality we have integrated by parts. This term is simply the SUSY extension of the standard $J^\mu A_\mu$. Since the background vector field is non-dynamical by definition, we can think of it as an additional parameter of the theory. If we take for global symmetry the $U(1)_J$ topological then we see that the BF coupling is precisely the FI parameter.

There is a last term that we can add preserving SUSY. It is the Chern-Simons (CS) coupling. If the gauge group is $U(1)$ it takes the following form

$$\mathcal{L}_{CS} = k \int d^2\theta d^2\bar{\theta} \Sigma V \quad (2.47)$$

For non-Abelian gauge group, the action written in superspace notation can be found in [220–222].

The total Lagrangian is the sum of all the previous pieces.

Real and complex mass terms:

In $3d$ there are two types of mass terms. The first one is the standard quadratic term in the superpotential, present also in $4d$. In a vector-like theory, this mass term for a chiral superfield Q can be written

$$\mathcal{W}_{complex} = m_{\mathbb{C}} Q \tilde{Q} \quad (2.48)$$

We have highlighted the fact that the mass parameter associated to this term is complex.

The second kind of mass term is the real mass that we have already mentioned. A real mass can be induced by turning on a vector superfield \tilde{V} as a SUSY preserving background field

$$\tilde{\sigma} = m_{\mathbb{R}}, \quad \tilde{A}_i = \tilde{\lambda} = \tilde{\bar{\lambda}} = \tilde{D} = 0 \quad (2.49)$$

The effect is a modification of the Kahler potential

$$\int d^2\theta d^2\bar{\theta} \bar{Q} e^{m_{\mathbb{R}}\theta^2} Q \sim \left(\frac{m_{\mathbb{R}}}{2} |\phi_Q|^2 + im_{\mathbb{R}} e^{\alpha\beta} \bar{\psi}_{\alpha} \psi_{\beta} \right) \quad (2.50)$$

Since the real masses come from a background vector multiplet, they cannot enter in holomorphic objects such as the superpotential.

The physical mass of the chiral superfield is given by the combination

$$m = \sqrt{m_{\mathbb{R}}^2 + |m_{\mathbb{C}}|^2} \quad (2.51)$$

Moduli space:

The moduli space of vacua of $3d\mathcal{N} = 2$ gauge theories contains a Coulomb branch and a Higgs branch. The Higgs branch is parametrized by the scalars VEVs of the chiral superfields ϕ_Q . The Coulomb branch is parametrized by the scalar VEVs σ of the vector multiplet.

In a generic point of the Coulomb branch, the gauge group is broken to the Cartan subgroup $U(1)^r$ with $r = \text{rank } G$. Therefore, the Coulomb branch is parametrized by Cartan scalars σ^j in \mathbb{R}^r/W with W the Weyl group of the original gauge group G and σ^j the expectation values of the scalars in the massless Cartan $U(1)^r$ vector multiplets V^j .

Also in $3d$, non-perturbative effects can lead to a dynamically generated superpotential which lifts the classical moduli space degeneracy of the Coulomb branch.

Parity anomaly:

In this subsection, let us come back to the CS coupling (2.47). To make the situation a bit more general, let us consider $U(1)^n$ as a gauge group. The CS coupling takes the form

$$\mathcal{L}_{CS} = \sum_{a,b=1}^n k_{ab} \int d^2\theta d^2\bar{\theta} \Sigma^a V^b \quad (2.52)$$

This term is gauge invariant provided that the coupling is an integer $k_{ab} \in \mathbb{Z}$. Even if this is true at the classical level, the coupling may receive quantum corrections and become non-integer, leading to an anomaly. This is called *parity anomaly*.

At the quantum level, if we integrate out the charged fermions, there is an additional induced contribution to the CS term, coming from a one-loop diagram with charged fermions running in the loop.

$$k_{ab}^{eff} = k_{ab} + \frac{1}{2} \sum_i q_i^a q_i^b \text{sign}(m_i) \quad (2.53)$$

the sum runs over all fermions, q_i^a is the integer charge of the i^{th} chiral under the a^{th} $U(1)$ gauge group and m_i is the fermion mass given by $m_i = m_{\mathbb{R},i} + \sum_{a=1}^n q_i^a \sigma_a$.

In order for the theory to be anomaly free, we should have

$$k_{ab} + \frac{1}{2} \sum_i q_i^a q_i^b \in \mathbb{Z} \quad (2.54)$$

we see that If $\sum_i q_i^a q_i^b$ is odd then necessarily $k_{ab} \neq 0$ and parity is broken.

A similar parity anomaly also exists for non-abelian gauge group, see the discussion in [217].

Monopole operators

$3d$ gauge theories admit an interesting class of gauge-invariant disorder operators called monopole operators [223–225]. The word disorder means that they cannot be expressed in terms of a polynomial in the elementary fields. They are defined by prescribing suitable boundary conditions around a point for the gauge fields in the path integral. These operators carry a magnetic charge, hence their name monopole, and create some units of magnetic flux on a two-sphere surrounding their insertion point. Despite being local, these operators are more challenging to study and in particular to understand what happens when they are added to the Lagrangian. One kind of problem is for example to determine the scaling dimension $\Delta[\mathfrak{M}]$ of the monopole operator \mathfrak{M} . We increase our tools to study monopole operators when we add SUSY and study $3d \mathcal{N} = 2$ theories.

The presentation we gave to introduce monopole operators as disorder operators is based on a modern perspective. However this is not the description that was given when $3d$ SUSY gauge theories was a developing area. Monopole operators, \mathfrak{M}_i were introduced coming from dualizing the vector multiplets on the Coulomb branch. See [94, 103] for additional discussions.

In a free $3d$ Abelian theory with gauge coupling e_3^2 , we saw that the photon A_μ can be dualized and combine with the scalar in the vector multiplet to form a chiral multiplet whose lower component is given by

$$\mathfrak{M} = \exp\left(\frac{\sigma}{e_3^2} + i\gamma\right) \quad (2.55)$$

Its expectation value parametrizes the Coulomb branch. The connection between the low-energy variable \mathfrak{M} and the definition of monopole operators as disorder operators is the following: the latter provide a microscopic definition of the former. More precisely, we can define a disorder operator by removing the point x and requiring that we sum over gauge field configurations that have one unit of magnetic flux on the S^2 around the point x . This operator flows in the IR to the operator $\exp(i\gamma(x))$. Similarly for the real scalar in the vector multiplet, if we define the disorder operator by summing over field configurations in which the field $\sigma(y)$ has the singular behavior

$$\sigma(y) \simeq \frac{1}{2|x-y|} \quad \text{as } x \rightarrow y \quad (2.56)$$

it flows in the IR to the operator $\exp(2\pi\sigma(x)/e_3^2)$. Combining the two definitions, we conclude that the microscopic definition as disorder operator flows in the IR to the operator \mathfrak{M} .

In non-Abelian gauge theories, the story is similar. The scalar σ is in the adjoint representation of the gauge group G , and classically has no potential (just couplings to charged matter fields). A generic vacuum expectation value for σ breaks the gauge group $G \rightarrow U(1)^{r_G}$ where

r_G is the rank of G , and for generic values of σ where all matter fields and all off-diagonal vector fields are massive², one can dualize the r_G massless vector multiplets into chiral multiplets \mathfrak{M}_i ($i = 1, \dots, r_G$). The low-energy theory at generic points on the classical Coulomb branch thus includes r_G massless chiral multiplets \mathfrak{M}_i . In this case, the microscopic definition requires specifying the magnetic (or GNO) flux around the point x ; this flux is in $U(1)^{r_G} \subset G$, and is labelled by a weight of the dual magnetic group G^L modulo Weyl transformations. The Weyl freedom can be fixed by choosing $\sigma_1 \geq \dots \geq \sigma_{r_G}$ where σ_i is the eigenvalue of the adjoint scalar σ .

Let us concentrate on the pure $U(N)$ case. As explained before, the Coulomb branch is parametrized by chiral operators

$$\mathfrak{M}_i = \exp\left(\frac{\sigma_i}{g_3^2} + i\gamma_i\right) \quad (2.57)$$

with $i = 1, \dots, r_G$ and $\sigma_1 \geq \dots \geq \sigma_{r_G}$. This is, however, not the end because a superpotential is non-perturbatively generated via instanton effects. This superpotential is called Affleck-Harvey-Witten (AHW) [226] and takes the form

$$\mathcal{W}_{AHW} = \sum_{j=1}^{N-1} \frac{1}{X_j} \quad (2.58)$$

This superpotential lifts the entire Coulomb branch.

In the theory with flavors, the instantons described above sometimes have extra fermion zero modes which prevent them from generating a superpotential. In the theory with F chiral multiplets Q_i in the fundamental of $U(N)$ and F chiral multiplets \tilde{Q}_i in the anti-fundamental of $U(N)$, the Coulomb branch that remains after instanton effects is parametrized by

$$\mathfrak{M}^+ = \exp\left(\frac{\sigma_1}{g_3^2} + i\gamma_1\right), \quad \mathfrak{M}^- = \exp\left(-\frac{\sigma_N}{g_3^2} - i\gamma_N\right) \quad (2.59)$$

The notation \mathfrak{M}^\pm comes from the following fact. In the previous section, we introduced the concept of topological symmetry for $3d$ gauge theories. Given a theory based on the gauge group G its topological symmetry is given by the centre $Z(G)$. Monopole operators are the objects that are charged under this symmetry. Take for definiteness $G = U(N)$: its centre, hence its topological symmetry group, is $U(1)$. The topological charge of a monopole operator $\mathfrak{M}^{\vec{m}}$ with GNO flux $\vec{m} = (m_1, m_2, \dots, m_N)$ is

$$Q_T(\mathfrak{M}^{\vec{m}}) = \sum_{i=1}^N m_i \quad (2.60)$$

The two monopoles \mathfrak{M}^\pm in (2.59) corresponds to GNO flux $\vec{m}^+ = (1, 0, \dots, 0)$ and $\vec{m}^- = (0, \dots, 0, -1)$. Therefore, they have topological charge ± 1 hence the name. They correspond to monopole operators with minimal charge.

Additional non-perturbative effects change the Coulomb branch of $U(N)$ with F flavors.

²It is also not known how to dualize the photon in the presence of charged matter fields. Therefore it is crucial that they are massive at generic point on the Coulomb branch. It is indeed the case because the scalar σ couples to charged fields as a mass term. So at generic point on the Coulomb branch they are massive and can be integrated out.

- For $F < N - 1$: the classical moduli space is lifted completely, there is no supersymmetric vacuum.
- For $F = N + 1$: a smooth quantum moduli space exists.
- For $F = N + 1$: a quantum moduli space exists including the origin.
- For $F > N + 1$: a quantum moduli space exists but it has a singularity at the origin.

In the case of $USp(2N)$ with flavors, the Coulomb branch that remains after instanton effects is parametrized by

$$\mathfrak{M} \simeq \exp\left(\frac{2\sigma_1}{g_3^2} + 2i\gamma_1\right) \quad (2.61)$$

It corresponds to the monopole of minimal charge.

Superpotentials involving monopole operators have appeared in the literature in various circumstances. For example, they famously appear in the Aharony dual of $U(N)$ or $USp(2N)$ theories with fundamental quarks as we are going to review in Section 2.7.

Monopole superpotentials can also appear as the effect of reducing a $4d$ theory on a circle down to $3d$. A careful study of the moduli spaces indicates that, contrary to the naive dimensional reduction, the compactification on a circle of finite size allows for the generation of KK monopoles which enter the superpotential. These monopoles play a key role in consistently deriving $3d$ dualities from $4d$ ones. When reducing on a circle a pair of dual $4d$ theories, at the first step one obtains a $3d$ dual pair with monopole superpotentials. The monopole operators are charged under topological and axial symmetries and break these symmetries in $3d$ (such symmetries would be anomalous or non-existent in $4d$). At this point one can turn on various real mass deformations and recover $3d$ dualities without monopole superpotentials. This procedure has been successfully implemented for theories with various gauge and matter content.

When studying linear quiver, we use the following notation to denote monopoles $\mathfrak{M}^{0,0,\bullet,\bullet,\dots}$. A 0 in the i^{th} position means that there is vanishing GNO flux for the i^{th} gauge group, while a \bullet in the i^{th} position means that there is minimal GNO flux for the i^{th} gauge group.

For unitary gauge groups $U(N)$, the \bullet can be $+$ or $-$, $+$ refers to the minimal flux vector $\vec{m} = (1, 0^{N-1})$ and $-$ to the other minimal flux $\vec{m} = (0^{N-1}, -1)$. For a linear quiver with only unitary gauge groups the \bullet in the monopole $\mathfrak{M}^{0,0,\bullet,\bullet,\dots}$ are either all $+$ or all $-$.

For $USp(2N)$ gauge group, the \bullet refers to the minimal GNO flux vector $\vec{m} = (1, 0^{N-1})$.

The monopoles which are chiral ring generators have minimal GNO fluxes for each node, and the non-zero fluxes are turned on in a single connected group of nodes (of arbitrary length), of the form $\mathfrak{M}^{\dots,0,0,\bullet,\bullet,\bullet,0,\dots}$.

Moreover, we need the following formula for computing the charge of a monopole operator $\mathfrak{M}^{\vec{m}}$ under abelian global symmetry

$$Q(\mathfrak{M}^{\vec{m}}) = -\frac{1}{2} \sum_{\psi_i} Q(\psi_i) |\rho_{\psi_i}(\vec{m})| \quad (2.62)$$

2.2 Chiral ring

Let us discuss the concept of chiral ring which is characteristic of SUSY theories with at least four supercharges (therefore for both $4d\mathcal{N} = 1$ and $3d\mathcal{N} = 2$). We will see that it is a concept related to the moduli space of supersymmetric vacua. Let us start by the definition of chiral operators. Chiral operators, \mathcal{O}_i , are simply gauge invariant operators that are annihilated by the supercharges³ $\overline{Q}_{\dot{\alpha}}$.

$$\{\overline{Q}_{\dot{\alpha}}, \mathcal{O}_i\} = 0 \quad (2.63)$$

Chiral operators are defined modulo exact terms of the form $\{\overline{Q}_{\dot{\alpha}}, \dots\}$. The sum of two chiral operators is also a chiral operator as well as a product of two chiral operators. Therefore it forms a ring called the *chiral ring* [227].

Chiral operators enjoy special properties.

- They are independent of position x

$$\partial_{\mu}\mathcal{O}_1(x) = [P_{\mu}, \mathcal{O}_1(x)] \sim \{\overline{Q}_{\dot{\alpha}}, [Q_{\alpha}, \mathcal{O}_1(x)]\} \sim 0 \quad (2.64)$$

- The property (2.64) implies that expectation value of a product of chiral operators is independent of each of their positions

$$\langle \prod_i \mathcal{O}_i(x_i) \rangle = \langle \prod_i \mathcal{O}_i \rangle \quad (2.65)$$

- Finally invoking cluster decomposition and (2.65) we conclude that the correlation function factorizes

$$\langle \mathcal{O}_1(x_1)\mathcal{O}_2(x_2)\dots\mathcal{O}_n(x_n) \rangle = \prod_{i=1}^n \langle \mathcal{O}_i \rangle \quad (2.66)$$

From these properties, we can understand why there are no contact terms in the expectation value of a product of chiral fields. It comes from the independence of correlation functions of the positions x_i . Since they are independent of the positions they cannot contain delta functions.

The chiral operators that generate the chiral ring are called *chiral ring generators*. Many other properties can be found in [228].

Before going on, let us connect this brief introduction of the chiral ring to the moduli space of vacua. When the constraints coming from the equations of motion for the F and D fields are taken into account, they reproduce the relations between chiral ring operators. Therefore the chiral ring can be identified with the moduli space of vacua.

2.3 Notation for quiver gauge theories

All along this thesis we will use and abuse of the quiver notation to denote the theories we are studying. Almost all the time in this thesis, the quivers denote theories with 4-supercharges. Let us summarize here the notation that we will use.

³When a superspace formalism exists, $\overline{Q}_{\dot{\alpha}}$ and $\overline{D}_{\dot{\alpha}}$ are conjugate by $\exp(\overline{\theta}\theta\partial_x)$, so the chiral ring defined in terms of operators annihilated by $\overline{Q}_{\dot{\alpha}}$ is isomorphic to that defined using $\overline{D}_{\dot{\alpha}}$.

Quiver diagrams

- a circle node denotes a gauge group and the colour will specify which kind
 - a black node \textcircled{N} denotes $U(N)$
 - a red node \textcircled{N} denotes $SU(N)$
 - a blue node $\textcircled{2N}$ denotes $USp(2N)$
 - a green node \textcircled{N} denotes $SO(N)$
 - a purple node \textcircled{N} denotes $O(N)$
- a square node \boxed{N} denotes a flavor group and we use the same colour code as before⁴
- An oriented link between two nodes $\textcircled{N_1} \rightarrow \textcircled{N_2}$ denotes a chiral field in the fundamental representation of $SU(N_2)$ and in the anti-fundamental representation of $SU(N_1)$
- An (oriented or not) arc on a node \textcircled{N} denotes a chiral field in a rank-2 representation (most often in this thesis it will be the antisymmetric representation but it could also be the symmetric or adjoint representation)

Flips In this thesis, an important role will be played by a class of gauge singlet chiral field σ called flippers. We say that σ *flips an operator* \mathcal{O} when it enters the superpotential through the term $\sigma \cdot \mathcal{O}$. Most of the time, we will not draw these flippers in the quiver. Their presence can be inferred looking at the superpotential.

Superpotential In theories with 4-supercharges, the holomorphic function \mathcal{W} called the superpotential plays a really important role in the dynamics.

- A term in the superpotential is represented by a closed loop in the quiver notation. Often we will denote these terms by the geometrical shape and not by the actual names of the

fields. For example, for a cubic term represented by the following quiver  we will either write $\mathcal{W} = abc$ or $\mathcal{W} = \text{Triangle}$

- Concerning the flippers interaction, instead of writing $\mathcal{W} = \sigma \cdot \mathcal{O}$ we will often use the following notation $\mathcal{W} = \text{Flip}[\mathcal{O}]$. Using this notation, we could avoid giving a name to the flipper σ . When we want to refer to a specific flipper we will use the notation $\text{Flipper}[\mathcal{O}]$ (or an explicit name if we gave one).

⁴We can already say that there will be exceptions of this colour code. It happens when inside a quiver we have two (or more) identical nodes and we want the easiest way to distinguish what symmetry we are talking about.

2.4 Anomalies and 't Hooft anomaly matching

Here we will focus on zero-form continuous symmetries, though one can consider generalizations of the discussion to higher form symmetries and higher group structures and non-invertible symmetries, see the review [229]. This section is based on [178, 230].

Typically the deformation breaks explicitly some of the symmetry of CFT_{UV} and some of the symmetry might also be spontaneously broken: let us assume G_{UV} is the surviving fraction of the symmetry. This symmetry will be preserved during RG flow.

Importantly, we can say something more about the symmetry. If a theory possesses a global symmetry with a corresponding conserved current. We can turn on background gauge fields A_μ , valued in the Lie algebra of some subgroup of the symmetry group, coupled to this conserved current, and compute the effective action $\Gamma[A]$. As the current is conserved the gauge field comes with a gauge symmetry. We can then try to promote A_μ to be dynamical fields. However, there might be an obstruction to doing so, which goes under the name of 't Hooft anomaly. The obstruction comes about as the effective action of the theory might or might not be invariant under the gauge symmetry.

$$\Gamma[A^g] \stackrel{?}{=} \Gamma[A] \quad (2.67)$$

If the equality does not hold, we say that the (sub)group of the symmetry has a 't Hooft anomaly. In particular this means that the symmetry cannot be gauged, we cannot promote A_μ to be dynamical fields. The important fact of the 't Hooft anomalies is that they are computable. First, the anomaly of a continuous symmetry can be captured in $d = 2n$ dimensions⁵ by an $n + 1$ point one loop amplitude involving the conserved currents. In particular, in $d = 4$ the anomaly is proportional to

$$a_{G_1 G_2 G_3} = \text{Tr}_{\mathcal{R}} (G_1 G_2 G_3) \quad (2.68)$$

Here \mathcal{R} is the representation of the chiral fermions of the model under the G_i which are the groups corresponding to the three currents.

't Hooft anomalies are useful for us since they don't change during the RG-flow and thus are the same in the UV and the IR: this fact goes under the name of *'t Hooft anomaly matching condition*.

The previous discussion did not invoke supersymmetry and it is one of the few non-perturbative tools available in this case.

For convenience and because we will use the 't Hooft anomalies, we will present the formula in the context of $4d \mathcal{N} = 1$ gauge theory. Let us call G the gauge group, the matter is represented by the chiral fields Φ_i , $i = 1, \dots, s$. The matter transforms under the gauge group as: $\bigoplus_{i=1}^s n_i \mathbf{r}_i$. The global symmetry of the theory includes $U(1)_R$, some $U(1)$'s and some non-abelian factors $SU(n_i)$. The number of $U(1)$'s depends on the number of simple factors in G and on the superpotential.

$$\text{Tr}(R G_j^2) = \mu(\text{adj}_{G_j}) + \sum_{i=1}^s n_i (R_i - 1) \mu(\mathbf{r}_i) \quad (2.69)$$

⁵There is no 't Hooft anomalies for continuous global symmetry in odd dimension.

$$\text{Tr}(F_\alpha G_j^2) = \sum_{i=1}^s n_i q_i^\alpha \mu(\mathbf{r}_i) \quad (2.70)$$

F_α is the current associated to one of the $U(1)_\alpha$ global symmetry and q_i^α is the charge under this symmetry.

$$\text{Tr}(R^3) = \dim G + \sum_{i=1}^s n_i |\mathbf{r}_i| (R_i - 1)^3 \quad (2.71)$$

$$\text{Tr}(F_\alpha F_\beta F_\gamma) = \sum_{i=1}^s n_i |\mathbf{r}_i| q_i^\alpha q_i^\beta q_i^\gamma \quad (2.72)$$

$$\text{Tr}(F_I^3) = \sum_{i=1}^s n_i |\mathbf{r}_i| A(\mathbf{h}_i^I) \quad (2.73)$$

F_I is the current associated with one of the non-abelian factor of the globally symmetry and \mathbf{h}_i^I is the representation of the matter field under this symmetry.

The two group theoretic data involved in the computation of the anomalies are the Dynkin Index, μ and the anomaly coefficient A can be found for example in [231]. We report here the value that we are going to use

$SU(N)$	$ \mathbf{r} $	$\mu(\mathbf{r})$	$A(\mathbf{r})$
fundamental	N	$\frac{1}{2}$	1
adjoint	$N^2 - 1$	N	0
antisymmetric	$\frac{N}{2}(N - 1)$	$\frac{N-2}{2}$	$N - 4$
symmetric	$\frac{N}{2}(N + 1)$	$\frac{N+2}{2}$	$N + 4$

Table 2.3: Group theoretic data for $SU(N)$.

$USp(2N)$	$ \mathbf{r} $	$\mu(\mathbf{r})$	$A(\mathbf{r})$
fundamental	$2N$	$\frac{1}{2}$	0
adjoint (symmetric)	$N(2N + 1)$	$N + 1$	0
antisymmetric	$N(2N - 1) - 1$	$N - 1$	0

Table 2.4: Group theoretic data for $USp(2N)$.

$SO(N)$	$ \mathbf{r} $	$\mu(\mathbf{r})$	$A(\mathbf{r})$
vector	N	1	0
adjoint (antisymmetric)	$\frac{N}{2}(N - 1)$	$N - 2$	0
symmetric	$\frac{N}{2}(N + 1) - 1$	$N + 2$	0

Table 2.5: Group theoretic data for $SO(N)$.

For conjugate representation $\bar{\mathbf{r}}$, they satisfy the following relations

$$\mu(\bar{\mathbf{r}}) = \mu(\mathbf{r}) \quad (2.74)$$

$$A(\bar{\mathbf{r}}) = -A(\mathbf{r}) \quad (2.75)$$

2.5 a -maximization

The SCFT in the UV thus has an R-symmetry which is part of the superconformal group. We will only discuss deformations which preserve $\mathcal{N} = 1$ supersymmetry. We will also assume that some combination of this R-symmetry and an abelian subgroup of the global symmetry group of CFT_{UV} is not broken by the deformation, though, of course, as we introduce a scale the conformal symmetry is broken. In the IR, if we arrive to a conformal fixed point, we again acquire the superconformal R-symmetry. However, the superconformal symmetry in the UV and in the IR might not be the same symmetry. Nevertheless, the fact that the R-symmetry is intimately related to the superconformal group allows us to determine it in the IR. It goes under the name of a -maximization [232]. Let us review how it is working. Any conformal theory, supersymmetric or not, in $4d$ has two important numbers associated to it: these are referred to as the a and the c conformal anomalies. The conformal anomalies measure, among other things, the failure of the expectation value of the trace of the stress-energy tensor to vanish when the theory is placed on a curved background with metric $g_{\mu\nu}$

$$\langle T^\mu_\mu \rangle = \frac{c}{16\pi^2} W^2 - \frac{a}{16\pi^2} E_4 \quad (2.76)$$

where W is the Weyl tensor and E_4 is the Euler density, both built from certain combinations of the metric and its derivatives [233]. In superconformal theories, as the stress-energy tensor and the R-symmetry are part of the same symmetry algebra the various anomalies are interrelated. We can show the following extremely useful equations [234]

$$a = \frac{3}{32} (3\text{Tr } R^3 - \text{Tr } R) \quad (2.77)$$

$$c = \frac{1}{32} (9\text{Tr } R^3 - 5\text{Tr } R) \quad (2.78)$$

Here it is important that R is the R-symmetry in the superconformal group and the Tr is over the chiral fermions of the theory.

A breakthrough was obtained by Intriligator and Wecht when they gave a recipe to obtain the correct superconformal R-charges. They define a quantity called a_{trial} based on (2.77), that depends on real parameters associated with the abelian global symmetries that can mix with the R-symmetry

$$a_{trial}(\{\alpha\}) = \frac{3}{32} \left(3\text{Tr} \left(R + \sum_i \alpha_i U(1)^{(i)} \right)^3 - \text{Tr} \left(R + \sum_i \alpha_i U(1)^{(i)} \right) \right) \quad (2.79)$$

Where α_i are arbitrary real numbers associated to the i^{th} $U(1)$ global symmetry. Then they showed that

The superconformal R-symmetry maximizes a_{trial}

This procedure is named, for obvious reason, a -maximization.

Efficient way to implement a-maximization for quiver gauge theories The first thing to do is to parametrize all the R-charges of the fields in terms of free⁶ R-charges variables

⁶The word free means independent in this context and not free fields.

R_{free}^J . We have first to write enforce the vanishing of the ABJ anomaly for the R-symmetry. It corresponds to one equation for every gauge node. Then we have to write the constraints on the R-charges coming from superpotential terms. Finally, we can have additional constraints if there is additional discrete symmetry, like charge conjugation.

If there is no additional discrete symmetry imposing further constraints, the number of free R-charges is the same as the number of $U(1)$'s global symmetry. The number of $U(1)$'s global symmetry is equal to the number of matter chiral fields minus the number of gauge nodes and minus the number of independent terms in the superpotential.

$$\#U(1)'s \text{ global symmetry} = \# \text{ chiral fields} - \# \text{ gauge nodes} - \# \text{ independent terms in } \mathcal{W}$$

Once we have parametrized the R-charges of all fields $R_i(R_{free}^J)$, we can define the following trial quantity:

$$a_{trial} = \frac{3}{32} \left(3\text{TrR}(R_{free}^j)^3 - \text{TrR}(R_{free}^j) \right) \quad (2.80)$$

By defining

$$a_0[x] = \frac{3}{32} (3(x-1)^3 - (x-1)) \quad (2.81)$$

we can rewrite (2.80) as

$$a_{trial}(R_{free}^J) = \dim G a_0[2] + \sum_i n_i |\vec{r}_i| a_0[R_i] \quad (2.82)$$

Where G is the gauge group of the theory, R_i is the R-charge of the i chiral fields called Φ_i , $|\vec{r}_i|$ is the dimension of the representation under G of Φ_i and n_i is the number of chiral fields Φ_i . The first term in (2.82) is the contribution of the gauginos and the sum is over the chiral fields Φ_i .

Once a_{trial} is computed, we can maximize it (often numerically). The variables R_{free}^J that maximize a_{trial} are the R-charges at the superconformal IR fixed point.

Similarly, we can express the second central charge, c , by

$$c_{trial} = \dim G c_0[2] + \sum_i n_i |\vec{r}_i| c_0[R_i] \quad (2.83)$$

with

$$c_0[x] = \frac{1}{32} (9(x-1)^3 - 5(x-1)) \quad (2.84)$$

2.6 $4d \mathcal{N} = 1$ IR duality

In this section, we describe the phenomenon of Seiberg duality [38]. We start with the first conjectured duality involving $SU(N)$ gauge group and matter in the fundamental representation. After, we see generalizations to other gauge group and/or matter in different representations. The work of Seiberg gave new insight on this topic and allowed a deeper comprehension of the dynamics of SUSY gauge theories, also in the non-perturbative regime.

2.6.1 Seiberg-like dualities

Seiberg duality was originally formulated for $4d\mathcal{N} = 1$ SQCD. The gauge group is $SU(N)$, there are F flavors Q_i, \tilde{Q}^j $i, j = 1, \dots, F$ and a vanishing superpotential. The conjecture proposed by Seiberg [38] is that SQCD for $F > N + 1$ is dual to another theory at low energies. This statement is highly non-trivial since the two theories are different in the UV. Nevertheless, the claim is that they are actually describing the same degrees of freedom when we flow to the IR. We often call the original theory *electric theory* (eSQCD) and the dual theory *magnetic theory* (mSQCD). The reason is that the gauge coupling of one theory is the inverse of the one of the dual theory, as it happens in electromagnetism. Indeed, Seiberg duality is often called electric-magnetic duality. In quiver notation of section 2.3 the duality statement is the following

Seiberg duality:

Mapping:	$tr(Q\tilde{Q}) \longleftrightarrow \text{Flipper}[q\tilde{q}]$	
	$Q^N \longleftrightarrow q^{F-N}$	
	$\tilde{Q}^N \longleftrightarrow \tilde{q}^{F-N}$	(2.85)

In the original formulation [38], some scales are involved in the duality statement like the holomorphic scale Λ for eSQCD, $\tilde{\Lambda}$ for mSQCD and μ the RG scale. For our purpose it will not be necessary to keep track of these scales and therefore we will be slightly imprecise and not write them to gain in readability.

Now let us review some of the checks of this conjecture. The first one is the existence of a consistent mapping of the chiral ring generators. By consistent we mean that the quantum numbers under the global symmetries are the same for the operators on both sides of the mapping. In the case of $SU(N)$ SQCD we have written the mapping in (2.85). Another test that we can perform consists of deforming the electric theory and verifying that it has the expected effect on the magnetic side. In the $SU(N)$ case, it is easy to check that giving a mass to one flavor of the electric side corresponds (using the mapping) to an Higgsing in the magnetic theory. After integrating out the massive flavor, we are left with $SU(N)$ with $F - 1$ flavors on the electric side. On the magnetic side, after the Higgsing we are left with a $SU(F - N - 1)$ with $F - 1$ flavors and a flipper of the meson matrix. It corresponds precisely to the duality (2.85) with $F \rightarrow F - 1$. It is a non-trivial check of the consistency of the claim.

One of the main checks of a duality statement is the matching of the 't Hooft anomalies for the global symmetries. As reviewed in section 2.4, the 't Hooft anomalies are invariant under

the RG flow. Therefore they should match between two dual theories. In the case of the Seiberg duality, it has been shown to be the case. We summarize the 't Hooft anomalies in Table 2.6.

$\text{Tr}(\text{SU}(F)^3) :$	N	$\text{Tr}(\text{U}(1)_R^3) :$	$-2\frac{N^4}{F^2} + N^2 - 1$
$\text{Tr}(\text{SU}(F)^2 \text{U}(1)_B) :$	$\frac{N}{2}$	$\text{Tr}(\text{U}(1)_R^2 \text{U}(1)_B) :$	0
$\text{Tr}(\text{SU}(F)^2 \text{U}(1)_R) :$	$-\frac{N^2}{2F}$	$\text{Tr}(\text{U}(1)_B) :$	0
$\text{Tr}(\text{U}(1)_B^3) :$	0	$\text{Tr}(\text{U}(1)_R) :$	$-N^2 - 1$

Table 2.6: 't Hooft anomalies in SQCD (2.85).

It exists other tests consisting of matching other exact quantities such as the Hilbert series [235]. Another more recent test is the matching of the superconformal index [29, 30] that is another RG invariant quantity (see discussion in section 2.10). The matching of the index for Seiberg duality has been studied in [236] and a detailed analysis of the integral identities that relate the dualities is given in [26, 27].

Soon after the discovery of Seiberg many other dualities have been found, involving other gauge groups, different matter content and superpotential interactions. In the following we will present some of these extensions, the ones that are going to play a role in this thesis. The next duality is really similar to the Seiberg duality and has been found by Intriligator and Poulitot (IP) [45]. The electric theory is SQCD with $USp(2N)$ gauge group and $2F$ fundamentals. For $2F > 2N + 4$, this theory admits a magnetic dual theory given by

IP duality:

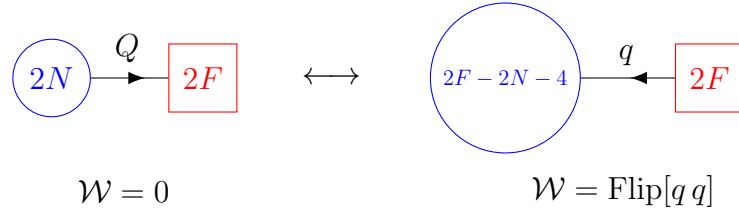

$$\text{Mapping:} \qquad \text{tr}(QQ) \longleftrightarrow \text{Flipper}[q q] \qquad (2.86)$$

This duality is even simpler than the Seiberg duality (2.85) because there is no baryon for the symplectic group.

Before going to review other extensions of the Seiberg duality in the next subsection, we want to analyze the lower bound case of the Seiberg and IP dualities. More precisely we want to comment on the case $F = N + 1$ respectively $2F = 2N + 4$ for $SU(N)$ respectively $USp(2N)$ SQCD. As reviewed in the introduction, these two cases corresponds to S-confining theories. The IR is then, by definition, captured by a theory with trivial gauge dynamics, that is a WZ model. The elementary fields of the IR WZ description map with the gauge invariant operators of the UV gauge theory. We can therefore also use our quiver notation of section 2.3 to describe these cases. Not surprisingly we call Seiberg S-confining duality⁷ the $SU(N)$ case [37] and IP S-confining duality the $USp(2N)$ case [45]. In quiver notation they read

⁷Before [37], [237] pointed out that the 't Hooft anomalies are matched by the mesons and baryons, but the confining superpotential was not found.

Seiberg S-confining duality:

$$\begin{array}{ccc}
 \begin{array}{c} \textcircled{N} \\ \swarrow \tilde{Q} \quad \searrow Q \\ \boxed{N+1} \quad \boxed{N+1} \end{array} & \longleftrightarrow & \begin{array}{c} \boxed{1} \\ \swarrow \tilde{B} \quad \searrow B \\ \boxed{N+1} \quad \boxed{N+1} \\ \longleftarrow M \end{array} \\
 \mathcal{W} = 0 & & \mathcal{W} = \det M - \text{Planar Triangle} \\
 \text{Mapping:} & & \begin{array}{l} \text{tr}(Q \tilde{Q}) \longleftrightarrow M \\ Q^N \longleftrightarrow B \\ \tilde{Q}^N \longleftrightarrow \tilde{B} \end{array}
 \end{array} \tag{2.87}$$

IP S-confining duality:

$$\begin{array}{ccc}
 \begin{array}{c} \textcircled{2N} \\ \rightarrow Q \\ \boxed{2N+4} \end{array} & \longleftrightarrow & \begin{array}{c} \boxed{2N+4} \\ \curvearrowright \mu \end{array} \\
 \mathcal{W} = 0 & & \mathcal{W} = \text{Pfaff}(\mu) \\
 \text{Mapping:} & & \text{tr}(QQ) \longleftrightarrow \mu
 \end{array} \tag{2.88}$$

2.6.2 Kutasov–Schwimmer-like dualities

In this subsection, we present different extensions of the Seiberg duality. They involve gauge theories with classical gauge group, matter in rank-2 and fundamental representations and a non-trivial superpotential in the form of a power of the rank-2 matter. The first of these dualities is for a $SU(n)$ gauge theory with a field in the adjoint representation and is due to Kutasov and Schwimmer [54, 55]. Later Intriligator proposed the variants for symplectic and special orthogonal gauge groups [53].

$SU(n)$ case with adjoint

We present the duality for the $SU(n)$ gauge theory with a field X in the adjoint representation⁸, F flavors and a non-trivial superpotential $\mathcal{W} = X^{k+1}$. This duality appeared in [54, 55]. The

⁸The adjoint field can be both taken to be traceful or traceless. On the dual the adjoint would be correspondingly traceful or traceless.

quiver summarizing this duality is the following:

$$(2.89)$$

We have noted the R-charges next to the fields.

The mapping of the chiral ring generators is the following:

$$(2.90)$$

$USp(2n)$ case with antisymmetric

The duality for the $USp(2n)$ case with an antisymmetric field A ,⁹ $2F$ fundamentals and a non-trivial superpotential $\mathcal{W} = A^{k+1}$ appeared in [53]. The duality is given by the following quiver:

$$(2.91)$$

The mapping of the chiral ring generators is the following:

$$(2.92)$$

$SO(n)$ case with symmetric

The $SO(n)$ case with a field in the symmetric representation,¹⁰ $2F$ chirals in the vector representation and a non-trivial superpotential $\mathcal{W} = S^{k+1}$ appeared in [53]. The duality is given by

⁹The same comment as in the footnote 8 applies for the antisymmetric field.

¹⁰The same comment as in the footnote 8 applies for the symmetric field.

the following quiver:

$$\begin{array}{ccc}
\begin{array}{c}
\textcircled{2n} \xrightarrow{Q} \boxed{2F} \\
\textcircled{S, \frac{2}{k+1}} \\
1 - \frac{2(n-2k)}{(k+1)F}
\end{array} & \iff & \begin{array}{c}
\textcircled{2k(F-2) - 2n} \xleftarrow{q} \boxed{2F} \\
\textcircled{T, \frac{2}{k+1}} \\
1 - \frac{2(k(F+2)-n)}{(k+1)F}
\end{array} \\
\mathcal{W} = S^{k+1} & & \mathcal{W} = T^{k+1} + \sum_{j=1}^k \text{Flip}[q T^{k-j} q]
\end{array} \tag{2.93}$$

The mapping of the chiral ring generators is the following:

$$\begin{array}{ccc}
S^j & \longleftrightarrow & T^j & j = 2, \dots, k \\
QS^{l-1}Q & & \text{Flipper}[qT^{k-l+1}q] & l = 1, \dots, k
\end{array} \tag{2.94}$$

2.6.3 Self-dualities modulo flips

In this subsection, we want to present some examples of the notion of *self-dual theories modulo flips* that we introduced in the introduction. We talk about self-duality modulo flips when the electric and magnetic theory share the same gauge structure, but differ by in the flipper side. Self-dualities modulo flips have been discussed in [64, 65, 197, 198]. The simplest case is $SU(2)$ with 8 chiral fields in the fundamental representation that we review now. There are 3 different-looking theories that are equivalent in the IR to the original $SU(2)$. In our quiver notation, they can be written like

$$\begin{array}{l}
\begin{array}{ccc}
\textcircled{2} \xrightarrow{Q} \boxed{8} & \mathcal{W} = 0 & \longleftrightarrow \\
\text{IP frame:} & \textcircled{2} \xleftarrow{q} \boxed{8} & \mathcal{W} = \text{Flip}[q q] \longleftrightarrow \\
\text{Seiberg frame:} & \begin{array}{c} \textcircled{2} \\ \swarrow \tilde{q} \quad \searrow q \\ \boxed{4} \quad \boxed{4} \end{array} & \mathcal{W} = \text{Flip}[q \tilde{q}] \longleftrightarrow \\
\text{CSST frame:} & \begin{array}{c} \textcircled{2} \\ \swarrow \tilde{q} \quad \searrow q \\ \boxed{4} \quad \boxed{4} \end{array} & \mathcal{W} = \text{Flip}[q q] + \text{Flip}[\tilde{q} \tilde{q}]
\end{array}
\end{array} \tag{2.95}$$

The first dual frame in (2.95) is an application of the IP duality (2.86) where we think $SU(2)$ as $USp(2)$. In this frame there are 28 flippers (the dimension of the antisymmetric representation of the $SU(8)$ global symmetry). The second dual frame is an application of Seiberg duality (2.85) where we have arbitrarily split the 8 into two groups of 4 and interpreted one of them as fundamental and the other as antifundamental. In this frame there are 16 flippers (the

dimension of the Seiberg meson in the bifundamental representation of the $SU(4) \times SU(4)$ global symmetry). The last frame was found by Csaki, Schmaltz, Skiba and Terning (CSST) in [65].

There is a generalization of this result. It involves a $USp(2N)$ gauge theory with matter in an antisymmetric representation and 8 chiral fields

$$\begin{aligned}
 & \text{Generalization IP frame:} \quad \begin{array}{c} \text{A} \\ \circlearrowleft \\ \text{2N} \end{array} \xrightarrow{Q} \boxed{8} \quad \mathcal{W} = 0 \quad \longleftrightarrow \\
 & \begin{array}{c} \text{A} \\ \circlearrowleft \\ \text{2N} \end{array} \xleftarrow{q} \boxed{8} \quad \mathcal{W} = \sum_{k=0}^{N-1} \text{Flip}[q A^k q] \quad \longleftrightarrow \\
 & \text{Generalization Seiberg frame:} \quad \begin{array}{c} \text{A} \\ \circlearrowleft \\ \text{2N} \\ \swarrow \quad \searrow \\ \boxed{4} \quad \boxed{4} \end{array} \quad \mathcal{W} = \sum_{k=0}^{N-1} \text{Flip}[l A^k r] \quad \longleftrightarrow \\
 & \text{Generalization CSST frame:} \quad \begin{array}{c} \text{A} \\ \circlearrowleft \\ \text{2N} \\ \swarrow \quad \searrow \\ \boxed{4} \quad \boxed{4} \end{array} \quad \mathcal{W} = \sum_{k=0}^{N-1} \text{Flip}[l A^k l] + \sum_{k=0}^{N-1} \text{Flip}[r A^k r] \quad \longleftrightarrow
 \end{aligned} \tag{2.96}$$

For $N = 1$ we get the result of (2.95). The first dual frame in (2.96) appears in [62]. The others dual frames appear in [238]. We will furnish a proof of the generalized IP frame in section 3.4.

Other self-dual theories modulo flips have been conjectured in [65].

2.7 $3d \mathcal{N} = 2$ Seiberg-like dualities

In this section, we discuss the similar phenomenon of Seiberg duality for $3d \mathcal{N} = 2$ theories. The prototypical duality of this kind has been discovered by Aharony [68]. The electric theory consists of SQCD with $U(N)$ gauge group and F pairs of fundamental and antifundamental chiral superfields. The magnetic dual theory is given by the following quiver

The first criterion follows from holomorphy of the dynamically generated superpotential. More precisely, for theories with no tree-level superpotential and only one gauge group, the symmetries and holomorphy completely determine the form of any non-perturbatively generated superpotential [40, 239]. Requiring the smoothness of this superpotential on the whole moduli space puts a constraint on the matter content of the theory. Concretely, [44] found the following constraint on the Dynkin indices of the matter¹¹

$$\sum_i \mu(\mathbf{r}_i) - \mu(\text{adjoint}) = 1 \quad (2.99)$$

This formula summarizes our first necessary condition for S-confinement, which enables us to rule out most theories immediately.

The second criterion follows from the study of different regions of the moduli space of the theory under consideration. The idea is simple and goes back to the definition of S-confining theory. The theory should have a smooth description in terms of gauge invariants everywhere on the moduli space. Therefore if we explore the moduli space of an S-confining theory, we should always end up with another S-confining theory. This observation leads to the second criterion which is a necessary condition. If by exploring the flat directions of a theory, we end up in a theory that does not admit a smooth description with only gauge invariant d.o.f then the original theory cannot be S-confining. The inverse statement is not true, if at some point of the moduli space we end up in an S-confining case it does *not* imply that the original theory is also S-confining.

Applying these two criteria, [44] produces Table 2.1, Table 2.2 and 2.3.

$SU(N)$	$(N+1)(\square + \bar{\square})$	s-confining
$SU(N)$	$\square + N\bar{\square} + 4\square$	s-confining
$SU(N)$	$\square + \bar{\square} + 3(\square + \bar{\square})$	s-confining
$SU(N)$	Adj $+\square + \bar{\square}$	Coulomb branch
$SU(4)$	Adj $+\square$	Coulomb branch
$SU(4)$	$3\square + 2(\square + \bar{\square})$	$SU(2)$: $8\square$
$SU(4)$	$4\square + \square + \bar{\square}$	$SU(2)$: $\square\square + 4\square$
$SU(4)$	$5\square$	Coulomb branch
$SU(5)$	$3(\square + \bar{\square})$	s-confining
$SU(5)$	$2\square + 2\square + 4\bar{\square}$	s-confining
$SU(5)$	$2(\square + \bar{\square})$	$Sp(4)$: $3\square + 2\square$
$SU(5)$	$2\square + \bar{\square} + 2\bar{\square} + \square$	$SU(4)$: $3\square + 2(\square + \bar{\square})$
$SU(6)$	$2\square + 5\bar{\square} + \square$	s-confining
$SU(6)$	$2\square + \bar{\square} + 2\bar{\square}$	$SU(4)$: $3\square + 2(\square + \bar{\square})$
$SU(6)$	$\square + 4(\square + \bar{\square})$	s-confining
$SU(6)$	$\square + \bar{\square} + 3\bar{\square} + \square$	$SU(5)$: $2\square + \bar{\square} + 2\bar{\square} + \square$
$SU(6)$	$\square + \bar{\square} + \bar{\square}$	$Sp(6)$: $\square + \bar{\square} + \square$
$SU(6)$	$2\square + \square + \bar{\square}$	$SU(5)$: $2(\square + \bar{\square})$
$SU(7)$	$2(\square + 3\bar{\square})$	s-confining
$SU(7)$	$\square + 4\bar{\square} + 2\square$	$SU(6)$: $\square + \bar{\square} + 3\bar{\square} + \square$
$SU(7)$	$\square + \bar{\square} + \square$	$Sp(6)$: $\square + \bar{\square} + \square$

Figure 2.1: Classification of S-confining theories with gauge group $SU(N)$, taken from [44].

¹¹In they used a different normalization for the Dynkin index so they get the following constraint $\sum_i \mu(\mathbf{r}_i) - \mu(\text{adjoint}) = 2$.

$Sp(2N)$	$(2N + 4) \square$	s-confining
$Sp(2N)$	$\square + 6\square$	s-confining
$Sp(2N)$	$\square\square + 2\square$	Coulomb branch
$Sp(4)$	$2\square + 4\square$	$SU(2)$: $8\square$
$Sp(4)$	$3\square + 2\square$	$SU(2)$: $\square\square + 4\square$
$Sp(4)$	$4\square$	$SU(2)$: $2\square\square$
$Sp(6)$	$2\square + 2\square$	$Sp(4)$: $2\square + 4\square$
$Sp(6)$	$\square + 5\square$	$Sp(4)$: $2\square + 4\square$
$Sp(6)$	$\square + \square + \square$	$SU(2)$: $\square\square + 4\square$
$Sp(6)$	$2\square$	$SU(3)$: $\square\square + \square\square$
$Sp(8)$	$2\square$	$Sp(4)$: $5\square$

Figure 2.2: TClassification of S-confining theories with gauge group $USp(2N)$, taken from [44].

$SO(14)$	(1, 0, 5)	s-confining
$SO(13)$	(1, 4)	s-confining
$SO(12)$	(1, 0, 7)	s-confining
$SO(12)$	(2, 0, 3)	s-confining
$SO(12)$	(1, 1, 3)	s-confining
$SO(11)$	(1, 6)	s-confining
$SO(11)$	(2, 2)	s-confining
$SO(10)$	(4, 0, 1)	s-confining
$SO(10)$	(3, 0, 3)	s-confining
$SO(10)$	(2, 0, 5)	s-confining
$SO(10)$	(3, 1, 1)	s-confining
$SO(10)$	(2, 1, 3)	s-confining
$SO(10)$	(1, 1, 5)	s-confining
$SO(10)$	(2, 2, 1)	s-confining
$SO(10)$	(1, 0, 7)	$SU(4)$ with $3\square + 2(\square + \bar{\square})$
$SO(9)$	(4, 0)	s-confining
$SO(9)$	(3, 2)	s-confining
$SO(9)$	(2, 4)	s-confining
$SO(9)$	(1, 6)	$SU(4)$ with $3\square + 2(\square + \bar{\square})$
$SO(8)$	(7, 0, 0)	Coulomb branch
$SO(8)$	(6, 1, 0)	Coulomb branch
$SO(8)$	(5, 2, 0)	$SU(4)$ with $3\square + 2(\square + \bar{\square})$
$SO(8)$	(5, 1, 1)	$SU(4)$ with $3\square + 2(\square + \bar{\square})$
$SO(8)$	(4, 3, 0)	s-confining
$SO(8)$	(4, 2, 1)	s-confining
$SO(8)$	(3, 3, 1)	s-confining
$SO(8)$	(3, 2, 2)	s-confining
$SO(7)$	(6, 0)	s-confining
$SO(7)$	(5, 1)	s-confining
$SO(7)$	(4, 2)	s-confining
$SO(7)$	(3, 3)	s-confining
$SO(7)$	(2, 4)	$SU(4)$ with $3\square + 2(\square + \bar{\square})$
$SO(7)$	(1, 5)	Coulomb branch

Figure 2.3: Classification of S-confining theories with gauge group $SO(N)$, taken from [44].

They also studied the exceptional groups. The only case they found is the G_2 gauge theory with 5 fundamentals. This case has already been discovered in [240].

In order to obtain these tables, they did the following. For each gauge group, they listed all matter content respecting the criterion (2.99) and then for each theory they studied directions on the moduli space. If they found a flow that rules out the S-confinement scenario, they give it on the second column.

2.9 Deconfinement method

Most of the examples of S-confining theories appearing in the classification of [44] reviewed in section 2.8 involve rank-2 matter, more precisely antisymmetric fields. Therefore if we want to consider the dualities of section 2.6.1 as building blocks, we need a way to get a situation in which only fundamental fields are present. This is doable and it is called deconfinement. The price we have to pay is an additional gauge group. We trade the rank-2 field by a confining gauge group. This method was introduced by Berkooz [60] and further developed in [63].

The original deconfinement method of [60] was for $SU(2N)$ with an antisymmetric field and it reads

$$\mathcal{W} = \text{Pfaff}(A) \quad \longleftrightarrow \quad \mathcal{W} = 0 \quad (2.100)$$

The justification is straightforward, we start on the r.h.s, we notice that the $USp(2N - 4)$ is coupled to $2N$ fields, so we apply the USp building block (2.88) and we get the l.h.s.

We would prefer a situation where the superpotential is zero on the side with the antisymmetric field. A way has been found by Luty, Schmaltz and Terning [63]. It applies for any group G and it says

$$\mathcal{W} = \text{Planar Triangle} + \text{Flip}[ll] \quad (2.101)$$

On the r.h.s, N is the dimension of the fundamental representation of G (the antisymmetric field has indices X_{ij} with $i, j = 1, \dots, N$), K is the smallest integer such that $N + K - 4$ is even and $\text{Flipper}[ll]$ is an antisymmetric field of the flavor group. Few remarks

- Depending on the group G , there is additional matter, that contributes to cancel the gauge anomaly. However G is a spectator in this deconfinement.

- Planar Triangle corresponds to the term $lb\tilde{c}$ with the obvious contraction of indices.
- “ $X_{ij} \longleftrightarrow b_i b_j \equiv b_i^c b_j^d J_{cd}^{Usp}$ ”. We put the mapping into quotation mark because it does not correspond to gauge invariant operators.
- If $K > 1$ we have a fictitious $SU(K)$ global symmetry. It is fictitious because the only fields that transform under this symmetry are not present in the low-energy theory.

The justification of (2.101) goes as follows. We start once again from the r.h.s and notice that $USp(N + K - 4)$ is connected to $N + K$ so we can use our USp building block (2.88). The result is

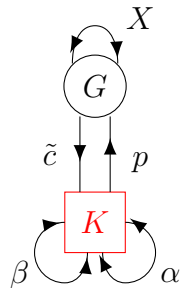

$$\mathcal{W} = \tilde{c}p + \alpha\beta + \text{Pfaff} \begin{pmatrix} & X & \vdots & p \\ \dots & \dots & \dots & \dots \\ & & \vdots & \alpha \end{pmatrix} \quad (2.102)$$

Then since \tilde{c} and β are massive we can integrate them out which put to zero p and α . Now if we look at the Pfaffian term, we see columns of zero and so it vanishes. Therefore we obtain the l.h.s of (2.101).

For $G = SU(2N)/USp(2N)/SO(2N)$ K is an even integer greater or equal to 2, so using this method there is a fictitious global symmetry (this $SU(2N)$ deconfinement appears in Terning [66]). For our purposes this is not enough, we need a deconfinement without this additional fake symmetry group. When the theories have at least one matter fields in the fundamental representation we can avoid it.

Our deconfinement version of $SU(2N)$:

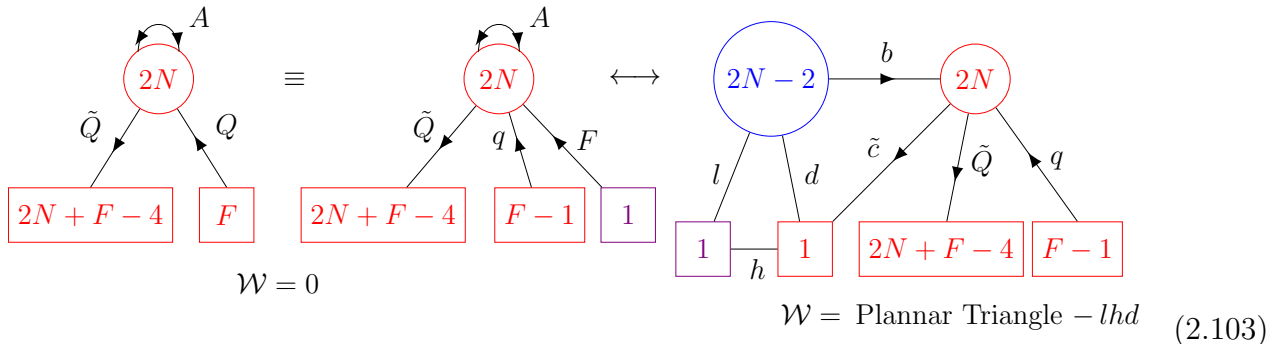

$$\mathcal{W} = \text{Planar Triangle} - lhd \quad (2.103)$$

This type of $4d \mathcal{N} = 1$ deconfinement reduces to the $3d \mathcal{N} = 2$ deconfinement used in [85] and

also appeared in [241]. The mapping of the chiral ring generators is

$$\begin{array}{ccc}
q \tilde{Q} & & q \tilde{Q} \\
F \tilde{Q} & & l b \tilde{Q} \\
A \tilde{Q}^2 & & b b \tilde{Q}^2 \\
\varepsilon_{2N} \tilde{Q}^{2N} & \iff & \varepsilon_{2N} \tilde{Q}^{2N} \\
\varepsilon_{2N} A^N & & h \\
\varepsilon_{2N} (A^{N-J} q^{2J}) & & \varepsilon_{2N} (b^{2N-2J} q^{2J}) \quad J = 1, \dots, \lfloor \frac{F-1}{2} \rfloor \\
\varepsilon_{2N} (A^{N-1} q F) & & \tilde{c} q \\
\varepsilon_{2N} (A^{N-K} q^{2K-1} F) & & \varepsilon_{2N} (b^{2N-2K} l b q^{2K-1}) \quad K = 2, \dots, \lfloor \frac{F}{2} \rfloor
\end{array} \tag{2.104}$$

The trick was to split the F fundamental fields into $F-1$ and 1 and use this extra 1 to deconfine without introducing any extra "fake" global symmetry. The proof of (2.103) is similar to the previous ones. We start on the r.h.s by confining the $USp(2N-2)$ gauge group. The initial superpotential terms become mass terms of the unwanted mesons which therefore are set to 0. This kills the would-be Pfaffian term because, as before, we get a vanishing column. The sign in the superpotential in (2.103) is designed such that the mapping (2.104) involves only + sign (if we consider $+lhd$ in(2.103), the mapping (2.104) becomes $\varepsilon_{2N} A^N \longleftrightarrow -h$).

Our deconfinement version of $USp(2N)$:

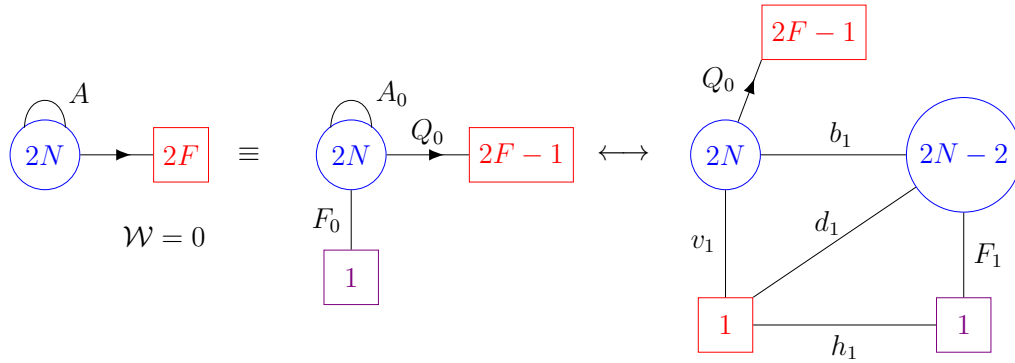

$$W = \text{Planner Triangle} - d_1 F_1 h_1 + \text{Flip}[b_1 b_1] \tag{2.105}$$

In this situation we should add the Flipper $[b_1 b_1]$ because we want the antisymmetric A_0 on the l.h.s to be traceless¹².

In this case the mapping is

$$\begin{array}{ccc}
Q_0 A_0^i F_0 & & Q_0 b_1 (b_1 b_1)^i F_1 \quad i = 0, \dots, N-2 \\
Q_0 A^{N-1} F_0 & & Q_0 v_1 \\
Q_0 A^j Q_0 & \iff & Q_0 (b_1 b_1)^j Q_0 \quad j = 0, \dots, N-1 \\
\text{tr } A^k & & \text{tr } (b_1 b_1)^k \quad k = 2, \dots, N-1 \\
\text{tr } A^N & & h_1
\end{array} \tag{2.106}$$

Let us write more explicitly the indices of the operators.

¹²Meaning $A_0^{\alpha\beta} J_{\alpha\beta} = 0$ with $J_{\alpha\beta}$ the invariant tensor of $USp(2N)$

- $Q_0 A_0^j Q_0 \equiv (Q_0)_{i_1}^{\alpha_1} A_0^{\alpha_2 \alpha_3} \dots A_0^{\alpha_{2j} \alpha_{2j+1}} (Q_0)_{i_2}^{\alpha_{2j+2}} J_{\alpha_1 \alpha_2}^{2N} \dots J_{\alpha_{2j+1} \alpha_{2j+2}}^{2N}$ that transforms in the antisymmetric representation of the $SU(2F - 1)$ global symmetry.
- $Q_0 (b_1 b_1)^j Q_0 \equiv (Q_0)_{i_1}^{\alpha_1} ((b_1)_{\beta_1}^{\alpha_2} (b_1)_{\beta_2}^{\alpha_3} J_{2N-2}^{\beta_1 \beta_2}) \dots ((b_1)_{\beta_{2J-1}}^{\alpha_{2J}} (b_1)_{\beta_{2J}}^{\alpha_{2J+1}} J_{2N-2}^{\beta_{2J-1} \beta_{2J}}) (Q_0)_{i_2}^{\alpha_{2j+2}} J_{\alpha_1 \alpha_2}^{2N} \dots J_{\alpha_{2j+1} \alpha_{2j+2}}^{2N}$
- $\text{tr} A_0^k \equiv A_0^{\alpha_1 \alpha_2} \dots A_0^{\alpha_{2k-1} \alpha_{2k}} J_{\alpha_2 \alpha_3}^{2N} \dots J_{\alpha_{2k-2} \alpha_{2k-1}}^{2N} J_{\alpha_{2k} \alpha_1}^{2N}$
- $\text{tr} (b_1 b_1)^k \equiv ((b_1)_{\beta_1}^{\alpha_1} (b_1)_{\beta_2}^{\alpha_2} J_{2N-2}^{\beta_1 \beta_2}) \dots ((b_1)_{\beta_{2J-1}}^{\alpha_{2J-1}} (b_1)_{\beta_{2J}}^{\alpha_{2J}} J_{2N-2}^{\beta_{2J-1} \beta_{2J}}) J_{\alpha_2 \alpha_3}^{2N} \dots J_{\alpha_{2k-2} \alpha_{2k-1}}^{2N} J_{\alpha_{2k} \alpha_1}^{2N}$

To summarize with these two ways of deconfining. The advantages are

- $\mathcal{W} = 0$
- No additional matter fields in the deconfined frame that introduces fictitious global symmetry

The disadvantage is the apparent breaking of the global symmetry

- $SU(2N)$ case: $SU(2N + F - 4) \times SU(F) \times U(1)^2 \longrightarrow SU(2N + F - 4) \times SU(F - 1) \times U(1)^3$
- $USp(2N)$ case: $SU(2F) \times U(1) \longrightarrow SU(2F - 1) \times U(1)^2$

For $G = SU(2N + 1)$ with F fundamentals we have $K = 1$ in (2.101). Therefore we have the following deconfinement version

Deconfinement of $SU(2N + 1)$:

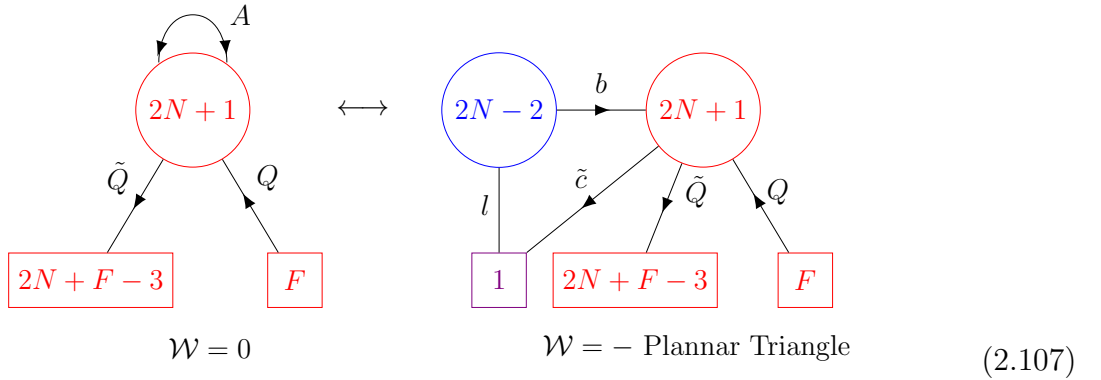

The mapping of the chiral ring generators is the following:

$$\begin{array}{ccc}
\begin{array}{l}
Q \tilde{Q} \\
A \tilde{Q}^2 \\
\varepsilon_{2N+1} \tilde{Q}^{2N+1} \\
\varepsilon_{2N+1} (A^N Q) \\
\varepsilon_{2N+1} (A^{N-J} Q^{2J+1})
\end{array} & \iff & \begin{array}{l}
Q \tilde{Q} \\
b b \tilde{Q}^2 \\
\varepsilon_{2N+1} \tilde{Q}^{2N+1} \\
\tilde{c} Q \\
\varepsilon_{2N+1} (b^{2N-2J} Q^{2J+1}) \quad J = 1, \dots, \lfloor \frac{F}{2} \rfloor - 1
\end{array}
\end{array} \tag{2.108}$$

This form of deconfinement appears first in Pouliot [58]. The sign in (2.107) is once again to have all + sign in the mapping of the chiral ring generators.

In the Chapter 3, we will apply the two S-confinements (2.87), (2.88) and the deconfinements (2.103) (2.105) to prove all S-confining dualities involving antisymmetric fields that we presented in section 2.8. The strategy is to first deconfine the rank-2 matter, then confine one by one all the gauge groups.

2.10 $4d \mathcal{N} = 1$ supersymmetric index

In this section, we briefly summarize some facts about the supersymmetric index of a $4d \mathcal{N} = 1$ theory, which coincides with the superconformal index [29, 30, 236] when computed with the superconformal R-symmetry (see also [242] for a review).

The index of a $4d \mathcal{N} = 1$ SCFT is a refined Witten index of the theory quantized on $S^3 \times \mathbb{R}$

$$\mathcal{I}_{\mathcal{N}=1} = \text{Tr}_{\delta=0} (-1)^F \left(\frac{p}{q} \right)^{j_1} (pq)^{j_2 + \frac{R}{2}} \prod_i f_i^{T_i}, \quad (2.109)$$

where

$$\delta = \frac{1}{2} \{ \mathcal{Q}, \mathcal{Q}^\dagger \} = 2j_2 + \frac{3}{2}R \quad (2.110)$$

with $\mathcal{Q} = \tilde{\mathcal{Q}}_-$ one of the Poincaré supercharges and $\mathcal{Q}^\dagger = \mathcal{S}$ the conjugate conformal supercharge, while j_1, j_2 are the Cartan generators of the isometry group $SO(4) = SU(2)_1 \times SU(2)_2$ of S^3 , R is the generator of the IR superconformal R-symmetry and T_i are \mathcal{Q} -closed generators of additional global symmetries of the theory. The parameters p and q are fugacities associated with the supersymmetry preserving squashing of the S^3 [236], while f_i are fugacities for the symmetries associated with the generators T_i .

The index counts gauge invariant operators (“words”) that can be constructed from modes of the fields (“letters”). The single letter indices for a vector multiplet and a chiral multiplet transforming in the representation \mathbf{R} of the gauge and flavor group and with R-charge R are

$$\begin{aligned} i_{\text{vec}}(p, q, U) &= \frac{2pq - p - q}{(1-p)(1-q)} \chi_{\text{adj}}(U), \\ i_{\text{chir}}^{\mathbf{R}}(p, q, U, V, R) &= \frac{(pq)^{\frac{R}{2}} \chi_{\mathbf{R}}(U, V) - (pq)^{\frac{2-R}{2}} \chi_{\overline{\mathbf{R}}}(U, V)}{(1-p)(1-q)}, \end{aligned} \quad (2.111)$$

where $\chi_{\mathbf{R}}(U, V)$ and $\chi_{\overline{\mathbf{R}}}(U, V)$ are the characters of the representation \mathbf{R} and the conjugate representation $\overline{\mathbf{R}}$, with U and V gauge and flavor group matrices, respectively.

The index is obtained by symmetrizing of all of such letters into words and then projecting them to the gauge invariant ones by integrating over the Haar measure of the gauge group. This takes the general form

$$\mathcal{I}_{\mathcal{N}=1}(p, q, V) = \int [dU] \prod_k \text{PE}[i_k(p, q, U, V)], \quad (2.112)$$

where k labels the different multiplets in the theory and $\text{PE}[i_k]$ is the plethystic exponential of the single letter index of the k -th multiplet

$$\text{PE}[i_k(p, q, U, V)] = \exp \left[\sum_{m=1}^{\infty} \frac{1}{m} i_k(p^m, q^m, U^m, V^m) \right], \quad (2.113)$$

which implements the symmetrization of the letters.

Let us consider the example of an $SU(n)$ gauge group. The contribution of a chiral superfield in the fundamental representation \mathbf{n} or anti-fundamental representation $\bar{\mathbf{n}}$ of $SU(n)$ with R -charge R can be written as follows:

$$\text{PE} [i_{\text{chir}}^{\mathbf{n}}(p, q, U)] = \prod_{a=1}^n \Gamma_e \left((pq)^{\frac{R}{2}} z_a \right), \quad \text{PE} [i_{\text{chir}}^{\bar{\mathbf{n}}}(p, q, U)] = \prod_{a=1}^n \Gamma_e \left((pq)^{\frac{R}{2}} z_a^{-1} \right), \quad (2.114)$$

where z_a with $a = 1, \dots, n$ and $\prod_{a=1}^n z_a = 1$ are the fugacities parametrizing the Cartan subalgebra of $SU(n)$ and the elliptic gamma function is defined as

$$\Gamma_e(x) \equiv \Gamma_e(x; p, q) = \prod_{i,j=1}^{\infty} \frac{1 - p^i q^j x^{-1}}{1 - p^{i+1} q^{j+1} x}. \quad (2.115)$$

We will also use the shorthand notation

$$\Gamma_e(x^{\pm h}) = \Gamma_e(x^h) \Gamma_e(x^{-h}). \quad (2.116)$$

On the other hand, the contribution of the vector multiplet in the adjoint representation of $SU(n)$ together with the $SU(n)$ Haar measure can be written as

$$\frac{(p; p)_{\infty}^n (q; q)_{\infty}^n}{n!} \oint_{\mathbb{T}^{n-1}} \prod_{a=1}^{n-1} \frac{dz_a}{2\pi i z_a} \prod_{a \neq b}^n \frac{1}{\Gamma_e(z_a z_b^{-1})} \Big|_{\prod_{a=1}^n z_a = 1} (\dots), \quad (2.117)$$

where the (\dots) indicates the rest of the index which receives contribution from the chiral matter fields transforming in various representations of the gauge group. The integration contour is taken over a unitary circle in the complex plane for each element of the maximal torus of the gauge group. The prefactor $(p; p)_{\infty}^n (q; q)_{\infty}^n$ is the contribution of n $U(1)$ free vector multiplets, one for each Cartan element of the gauge group $SU(n)$, where $(x; q) = \prod_{n=0}^{\infty} (1 - xq^n)$ is the q -Pochhammer symbol.

For completeness, we report the parametrization we used for the characters of various representations of the groups $USp(2n)$ and $SO(n)$ that appeared in the main text. For $USp(2n)$ we mainly consider fundamental $\mathbf{2n}$, adjoint $\mathbf{n(2n+1)}$ and (traceless) antisymmetric $\mathbf{n(2n-1)-1}$ representations

$$\begin{aligned} \chi_{\mathbf{2n}}^{USp(2n)} &= \sum_{a=1}^n z_a + z_a^{-1}, \\ \chi_{\mathbf{n(2n+1)}}^{USp(2n)} &= n + \sum_{a=1}^n (z_a^2 + z_a^{-2}) + \sum_{a < b}^n (z_a z_b + z_a z_b^{-1} + z_a^{-1} z_b + z_a^{-1} z_b^{-1}), \\ \chi_{\mathbf{n(2n-1)-1}}^{USp(2n)} &= n - 1 + \sum_{a < b}^n (z_a z_b + z_a z_b^{-1} + z_a^{-1} z_b + z_a^{-1} z_b^{-1}). \end{aligned} \quad (2.118)$$

For $SO(n)$ the characters of the representations are different depending on whether n is even or odd, so it is useful to write $n = 2k + \epsilon$ with k the rank of the group and $\epsilon = 0, 1$. The

main representations that we consider are the vector \mathbf{n} , the adjoint $\frac{\mathbf{n}(\mathbf{n}-1)}{2}$ and the (traceless) symmetric representations $\frac{\mathbf{n}(\mathbf{n}+1)-2}{2}$

$$\begin{aligned}
\chi_{\mathbf{n}}^{SO(n)} &= \epsilon + \sum_{a=1}^k z_a + z_a^{-1}, \\
\chi_{\frac{\mathbf{n}(\mathbf{n}-1)}{2}}^{SO(n)} &= k + \epsilon \sum_{a=1}^k (z_a + z_a^{-1}) + \sum_{a<b}^n (z_a z_b + z_a z_b^{-1} + z_a^{-1} z_b + z_a^{-1} z_b^{-1}), \\
\chi_{\frac{\mathbf{n}(\mathbf{n}+1)-2}{2}}^{SO(n)} &= k + \epsilon - 1 + \epsilon \sum_{a=1}^k (z_a + z_a^{-1}) + \sum_{a=1}^k (z_a^2 + z_a^{-2}) + \sum_{a<b}^k (z_a z_b + z_a z_b^{-1} + z_a^{-1} z_b + z_a^{-1} z_b^{-1}).
\end{aligned} \tag{2.119}$$

Other useful characters are those for the symmetric $\frac{\mathbf{n}(\mathbf{n}+1)}{2}$ and anti-symmetric $\frac{\mathbf{n}(\mathbf{n}-1)}{2}$ representations of $SU(n)$

$$\begin{aligned}
\chi_{\frac{\mathbf{n}(\mathbf{n}+1)}{2}}^{SU(n)} &= \sum_{a \leq b}^n z_a z_b, \\
\chi_{\frac{\mathbf{n}(\mathbf{n}-1)}{2}}^{SU(n)} &= \sum_{a < b}^n z_a z_b,
\end{aligned} \tag{2.120}$$

where as usual for $SU(n)$ fugacities we have $\prod_{a=1}^n z_a = 1$.

Chapter 3

Power of deconfinement

The content of this Chapter is essentially taken from [1, 2].

3.1 Introduction

A line of research is concerned with the derivation of IR dualities involving rank-two matter applying known more basic dualities. In this Chapter we will present our contribution in this project. We will use the deconfinement method reviewed in Section 2.9 to prove all S-confining dualities involving one node quivers and matter in rank-1 and/or rank-2 representations of Section 2.8. The set of theories includes 3 infinite series: $USp(2N)$ with antisymmetric and 3 flavors, $SU(N)$ with antisymmetric and $(4, N)$ flavors, $SU(N)$ with antisymmetric, conjugate antisymmetric and $(3, 3)$ flavors. Moreover there are 4 exceptional cases, with $SU(5)$, $SU(6)$, $SU(7)$ gauge group and 2 or 3 antisymmetric fields plus flavors.¹

Then we will work out the *sequentially deconfined* dual of $4d \mathcal{N} = 1 USp(2N)$ with antisymmetric and $2F$ fundamentals, uplifting the $3d \mathcal{N} = 2$ results of [85]. This means that we step by step prove a duality with a linear quiver gauge theories with N nodes and a certain *saw* structure, full details of the theory are in (3.3.2). This fully deconfined dual frame enjoys the nice property that all the chiral ring operators are gauge singlet fields, similarly to what happens for IP and Aharony dualities.² We will then use this fully deconfined frame to prove the known self-duality of $USp(2N)$ with 4 flavors. More precisely, to derive the generalization of the IP frame in (2.96).

In the two sporadic $SU(5)$ cases and during the sequential deconfinement of $USp(2N)$ with antisymmetric and $2F$ fundamentals, we will face a subtlety that we call *degenerate holomorphic operator ambiguity*³. As the name suggests, this phenomenon appears when we reach a frame that contains more than one gauge invariant holomorphic operator with the same global symmetry quantum numbers (including $U(1)_R$), but only one combination is a chiral protected

¹[46] also found non-quivers S-confining models, with $Spin(N)$ gauge group and spinorial matter, and a $SU(6)$ model with a rank-3 antisymmetric representation. Our techniques cannot tackle such cases. We leave this problem to future work.

²This property cannot be enjoyed by theories with general baryonic operators in the chiral ring, such as in $SU(N)$ SQCD or in the sequentially deconfined $3d \mathcal{N} = 2 SO$ gauge theories [243].

³This subtlety is also present in the $3d$ version of the sequential deconfinement story [85] but was overlooked.

operator. If such an operator is flipped by a gauge singlet, only one specific combination appears in the superpotential. In the examples we encounter in this chapter, it happens that if we follow the rules of Seiberg duality (as is usually done) we end up with the incorrect result. In some cases we can determine which is the precise combination of operators appearing in the chiral ring (equivalently, the combination that can be flipped) by going in a dual frame and using classical F-terms relations there. Hence, in the original theory with degenerate holomorphic operator ambiguity, the ambiguity is resolved by quantum relations. In the case of $F = 4$, the precise superpotential is crucial in the proof of the self-duality modulo flips, so this case provides a good consistency check of our procedure.

This chapter is organized as follows.

In section 3.2, we present the proof of the S-confining one node quivers without superpotential.

In section 3.3, we present the general sequential deconfinement of $USp(2N)$ with an anti-symmetric and $2F$ fundamentals.

In section 3.4, we set $2F = 8$, which allows to sequentially reconfine the quiver tail, and prove the self-duality modulo flips of the theory.

In section 3.5, we show how to reduce our $4d \mathcal{N} = 1 USp(2N)$ story to $3d \mathcal{N} = 2$, re-obtaining the results of for $U(N)$ and $USp(2N)$ found in [85]. Along the way we also derive new sequentially deconfined duals, namely for $U(N)$ with adjoint and (F, F) fundamentals with monopole superpotentials.

In section 3.6, we give an outlook.

3.2 Proof of the S-confining theories

3.2.1 $USp(2N)$ with $\square + 6\square$ series

Let us start from $USp(2N)$ gauge theory with one antisymmetric and 6 fundamental fields. This theory has a continuous global symmetry $SU(6) \times U(1)$ (on top of the $U(1)_R$ symmetry). We also turn on a superpotential



$$\mathcal{W} = \sum_{i=2}^N \text{Flip}[A^i] \tag{3.1}$$

The F-term equations of the Flipper $[A^i]$ set the $\text{tr}(A^i)$ to 0 on the chiral ring. In addition, on the quantum chiral ring these flippers are not generators. We can understand it as follows: Start with the theory with $\mathcal{W} = 0$. After a-maximization [232], we discover that the operators $\text{tr}(A^i)$ violate the unitary bound. Therefore, we expect that in the IR the theory breaks into a free and an interacting part. If we want to focus on the interacting part, the procedure is to flip these operators [95] and the flippers are not generators of the quantum chiral ring.

The conclusion is that the quantum chiral ring generators of (3.1) are the dressed mesons: $\text{tr}(q A^a q)$, $a = 0, \dots, N - 1$ and these are the operators that we have to map. We turned on this superpotential because it will be much easier to keep track of the superpotential when doing the sequence of confinement/deconfinement.

Now we start by using the trick of splitting the 6 fundamentals into $5 + 1$

$$\begin{aligned}
 \mathcal{T}_0 : \quad & \begin{array}{c} \text{Diagram 1: } \text{Circle}(2N) \xrightarrow{q} \text{Square}(6) \\ \text{Diagram 2: } \text{Circle}(2N) \xrightarrow{Q_0} \text{Square}(5) \\ \text{Diagram 3: } \text{Circle}(2N) \xrightarrow{F_0} \text{Square}(1) \end{array} \equiv \\
 \mathcal{W} = \sum_{i=2}^N \text{Flip}[A^i] & \qquad \qquad \qquad \mathcal{W} = \sum_{i=2}^N \text{Flip}[A_0^i]
 \end{aligned} \tag{3.2}$$

The first step is the use of the deconfinement (2.105).

$$\begin{aligned}
 \mathcal{T}_{0'} : \quad & \begin{array}{c} \text{Diagram: } \text{Circle}(2N) \xrightarrow{Q_0} \text{Square}(5) \\ \text{Diagram: } \text{Circle}(2N) \xrightarrow{b_1} \text{Circle}(2N-2) \\ \text{Diagram: } \text{Circle}(2N) \xrightarrow{v_1} \text{Square}(1) \\ \text{Diagram: } \text{Circle}(2N-2) \xrightarrow{d_1} \text{Square}(1) \\ \text{Diagram: } \text{Circle}(2N-2) \xrightarrow{F_1} \text{Square}(1) \end{array} \\
 \mathcal{W} = \text{Planar Triangle} & \\
 + \text{Flip}[b_1 b_1] + \sum_{i=2}^{N-1} \text{Flip}[(b_1 b_1)^i] &
 \end{aligned} \tag{3.3}$$

In this section and in the following, for simplicity, we will not pay attention to the signs in front of the various terms in the superpotential. Let us remark that the h_1 field has been integrated out using the e.o.m of the massive Flipper $[A_0^N]$. Now we see that the $USp(2N)$ is coupled to $2N - 2 + 5 + 1 = 2N + 4$ fundamental fields. Therefore we can apply the basic S-confining result (2.88). We get

$$\begin{aligned}
 \text{Diagram: } & \begin{array}{c} \text{Circle}(2N-2) \xrightarrow{Q_1} \text{Square}(5) \xrightarrow{M_1} \text{Square}(5) \\ \text{Circle}(2N-2) \xrightarrow{F_1} \text{Square}(1) \\ \text{Circle}(2N-2) \xrightarrow{p_1} \text{Square}(1) \\ \text{Square}(1) \xrightarrow{O_1} \text{Square}(5) \\ \text{Square}(1) \xrightarrow{d_1} \text{Circle}(2N-2) \end{array} \\
 \mathcal{W} = p_1 d_1 + \text{Flip}[A_1] + \sum_{i=2}^{N-1} \text{Flip}[A_1^i] & \\
 + \text{Pfaff} \begin{pmatrix} A_1 & Q_1 & p_1 \\ & M_1 & O_1 \\ & & 0 \end{pmatrix} &
 \end{aligned} \tag{3.4}$$

The E.O.M of Flipper $[A_1]$ and d_1 set $\text{tr}(A_1) \equiv (A_1)^{\alpha_1 \alpha_2} J_{\alpha_1 \alpha_2}^{2N-2} = 0$ and $p_1 = 0$. Therefore the

Pfaffian term becomes

$$\begin{aligned} \text{Pfaff } \mu = \text{Pfaff} \begin{pmatrix} A_1 & Q_1 & 0 \\ & M_1 & O_1 \\ & & 0 \end{pmatrix} &\sim \varepsilon_{a_1 \dots a_{2N+4}} \mu^{a_1 a_2} \dots \mu^{a_{2N+3} a_{2N+4}} \\ &= \varepsilon_{2N-2} \varepsilon_5 [A_1^{N-1} M_1^2 O_1 + A_1^{N-2} Q_1^2 M_1 O_1 + A_1^{N-3} Q_1^4 O_1] \end{aligned} \quad (3.5)$$

Let us focus on the first term: $\varepsilon_{2N-2} \varepsilon_5 [A_1^{N-1} M_1^2 O_1] = \varepsilon_{2N-2} [A_1^{N-1}] \varepsilon_5 [M_1^2 O_1]$. We claim that we can drop this term. Indeed the part $\varepsilon_{2N-2} [A_1^{N-1}]$ can be written, by linear algebra, as the product of the traces of all powers of A_1^i (which are all set to 0 on the chiral ring by the F-term equations of Flipper $[A_1^i]$). Then using the chiral ring stability argument⁴ [95] on $\varepsilon_{2N-2} \varepsilon_5 [A_1^{N-1} M_1^2 O_1]$ we conclude that we can remove this term from the full superpotential in (3.4). More generally, the chiral ring stability allows us to drop terms of the form: $\varepsilon_{2c} [A^c] \varepsilon_5 [M_i M_j O_k]$ with $c > 0$ ⁵. Therefore from now on we will discard these terms. This is the reason why we turn on the superpotential in (3.2), to avoid the proliferation of this kind of term.

\mathcal{T}_1 :

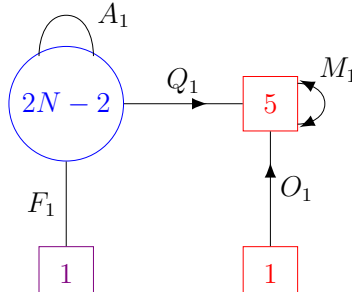

$$\begin{aligned} \mathcal{W} &= \sum_{i=2}^{N-1} \text{Flip}[A_1^i] \\ &\quad + \varepsilon_{2N-2} \varepsilon_5 [A_1^{N-2} Q_1^2 M_1 O_1 \\ &\quad + A_1^{N-3} Q_1^4 O_1] \end{aligned} \quad (3.6)$$

The next step is to deconfine again the antisymmetric field. We get

\mathcal{T}_1' :

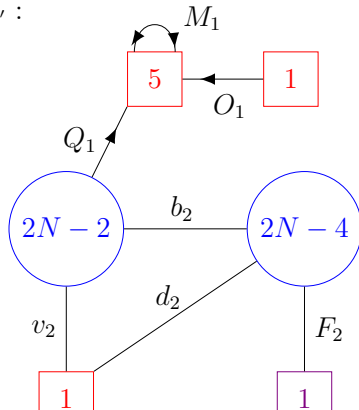

$$\begin{aligned} \mathcal{W} &= \text{Plannar Triangle} + \text{Flip}[b_2 b_2] + \sum_{i=2}^{N-2} \text{Flip}[(b_2 b_2)^i] \\ &\quad + \varepsilon_{2N-2} \varepsilon_5 [b_2^{2N-4} Q_1^2 M_1 O_1 + b_2^{2N-6} Q_1^4 O_1] \end{aligned} \quad (3.7)$$

⁴The chiral ring stability argument says the following [95]: Start with a theory with superpotential $\mathcal{W}_{\mathcal{T}} = \sum_i \mathcal{W}_i$. For each i , consider the modified theory \mathcal{T}_i where the term \mathcal{W}_i is removed. Then, check if the operator \mathcal{W}_i is in the chiral ring of \mathcal{T}_i . If it is not, drop \mathcal{W}_i from the full superpotential \mathcal{W} .

⁵Even if we don't want to use the chiral ring stability criterion, these terms will disappear once we reach the final frame. Indeed every power of the antisymmetric field will at some point be mapped to a singlet h_a field. This singlet will enter in the superpotential as a mass term with one flipper Flipper $[A]$. Therefore when we integrate out the massive flipper Flipper $[A^{N-k}]$, its E.O.M set h_{k+1} to 0. Conclusion, if we are doing enough confinement/deconfinement steps, these terms $\varepsilon_{2c} [A^c] \varepsilon_5 [M_i M_j O_k]$ with $c > 0$ are set to 0.

Now we confine the $Usp(2N - 2)$. It is similar to the previous step between the frames \mathcal{T}_0 and \mathcal{T}_1 . There is once again a confining superpotential given by a Pfaffian term. What is interesting and non-trivial is the mapping of the existing superpotential terms in (3.7).

Let us start with $\varepsilon_{2N-2} \varepsilon_5 [b_2^{2N-4} Q_1^2 M_1 O_1]$. In principle when we deconfine the antisymmetric field A_1 with the $Usp(2N - 4)$ gauge group, the b_2 fields are contracted pairwise with the invariant tensor of the Usp group J^{2N-4} . Therefore a term like $\varepsilon_{2N-2} \varepsilon_5 [b_2^{2N-4} Q_1^2 M_1 O_1]$ contain implicitly $N - 2$ invariant tensor J^{2N-4} that are contracted with the $2N - 4$ b_2 fields. But we can do something else. Since the number of b_2 fields is smaller than the order of ε_{2N-2} , the epsilon forces to antisymmetrize all the $2N - 4$ indices. So we can trade, modulo an irrelevant numerical factor, the bunch of J^{2N-4} for ε^{2N-4} . Putting indices we get

$$\begin{aligned} \varepsilon_{2N-2} \varepsilon_5 [b_2^{2N-4} Q_1^2 M_1 O_1] &\sim \varepsilon^{2N-4} \varepsilon_5 \varepsilon_{2N-2} [b_2^{2N-4} Q_1^2 M_1 O_1] \\ &= \varepsilon^{2N-4} \varepsilon_5 \varepsilon_{2N-2} \left[(b_2)_{\beta_1}^{\alpha_1} \dots (b_2)_{\beta_{2N-4}}^{\alpha_{2N-4}} (Q_1)_{i_1}^{\alpha_{2N-3}} (Q_1)_{i_2}^{\alpha_{2N-2}} (M_1)_{i_3 i_4} (O_1)_{i_5} \right] \end{aligned} \quad (3.8)$$

To improve the readability, we have colored the $Usp(2N - 4)$ indices in **magenta** and the $Usp(2N - 2)$ indices in **green**. Using this form, it is easier to see where this term is mapped to. Indeed, when we confine the $Usp(2N - 2)$, we have two different possibilities. Either we contract the two Q_1 together which gives the meson M_2 or we contract each Q_1 with a b_2 which gives a new fundamental Q_2 .

So after the confinement of $Usp(2N - 2)$, this term is mapped to

$$\bullet \varepsilon^{2N-4} \varepsilon_5 \varepsilon_{2N-2} [b_2^{2N-4} Q_1^2 M_1 O_1] \longrightarrow \varepsilon^{2N-4} \varepsilon_5 [A_2^{N-2} M_2 M_1 O_1 + A_2^{N-3} Q_2^2 M_1 O_1]$$

Again we use the chiral ring stability argument to remove the first term.

The second term we have to map is $\varepsilon_{2N-2} \varepsilon_5 [b_2^{2N-6} Q_1^4 O_1]$. The strategy is the same as for the previous term. We also trade the bunch of J^{2N-4} with ε^{2N-6} tensor⁶. Now there are 4 Q_1 to play with. We can form 3 different terms. The first one is contracting the 4 Q_1 among themselves. The second is contracting 2 Q_1 with 2 b_2 and the remaining 2 Q_1 together. The last one is contracting the 4 Q_1 with 4 b_2 .

So after the confinement of $Usp(2N - 2)$ we get

$$\bullet \varepsilon^{2N-6} \varepsilon_5 \varepsilon_{2N-2} [b_2^{2N-6} Q_1^4 O_1] \longrightarrow \varepsilon^{2N-6} \varepsilon_5 [A_2^{N-3} M_2^2 O_1 + A_2^{N-4} Q_2^2 M_2 O_1 + A_2^{N-5} Q_2^4 O_1]$$

After eliminating the first term using the chiral ring stability we get

\mathcal{T}_2 :

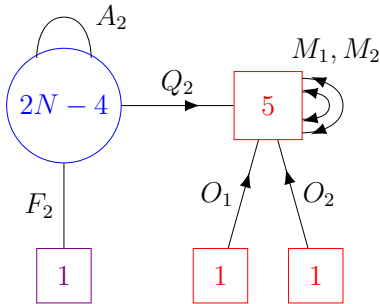

$$\begin{aligned} \mathcal{W} &= \sum_{i=2}^{N-2} \text{Flip}[A_2^i] + \varepsilon^{2N-4} \varepsilon_5 [A_2^{N-3} Q_2^2 M_1 O_1] \\ &\quad + \varepsilon^{2N-6} \varepsilon_5 [A_2^{N-4} Q_2^2 M_2 O_1 + A_2^{N-5} Q_2^4 O_1] \\ &\quad + \varepsilon^{2N-4} \varepsilon_5 [A_2^{N-3} Q_2^2 M_2 O_2 + A_2^{N-4} Q_2^4 O_2] \end{aligned} \quad (3.9)$$

⁶ ε^{2N-6} is an abuse of terminology. What we mean is a totally antisymmetric tensor with $2N - 6$ indices but each index goes from 1 to $2N - 4$.

We iterate this procedure of deconfinement/deconfinement. In the appendix A we present the theory in the arbitrary \mathcal{T}_k frame with the full superpotential.

After $N - 1$ iterations we get

\mathcal{T}_{N-1} :

$$\begin{aligned}
 \mathcal{W} &= \sum_{i=1}^{N-1} \varepsilon_2 \varepsilon_5 [Q_{N-1}^2 M_i O_i] \\
 &+ \sum_{k=1}^{N-2} \sum_{k+1 \leq i \leq j \leq N-1} \varepsilon_5 [M_i M_j O_k] \delta_{i+j-k, N}
 \end{aligned}
 \tag{3.10}$$

Now since we reach $Usp(2) \simeq SU(2)$ the traceless antisymmetric field simply does not exist anymore. Therefore there is nothing to deconfine and we can directly apply the building block once more. We reach the final ‘‘deconfined’’ frame

\mathcal{T}_{Dec} :

$$\begin{aligned}
 \mathcal{W} &= \sum_{N \geq a \geq b \geq c \geq 1} \varepsilon_6 [\mu^a \mu^b \mu^c] \delta_{a+b+c, 2N+1} \\
 \mu^a &= \left(\begin{array}{c} \overbrace{M_a \quad \dots \quad O_{N+1-a}}^5 \\ \vdots \\ \underbrace{\quad \quad \quad \quad \quad 0}_{1} \end{array} \right) \left. \begin{array}{l} \vphantom{\mu^a} \\ \vphantom{\mu^a} \\ \vphantom{\mu^a} \end{array} \right\} 5
 \end{aligned}
 \tag{3.11}$$

In the last equality, we have repackaged the superpotential in a manifestly $SU(6)$ invariant way. We recover the result of [46] and the superpotential for a generic N proposed in [92].

The mapping of the chiral ring generators between the original frame and the final one is the following

$$\begin{array}{ccc}
 \mathcal{T}_0 & & \mathcal{T}_{DEC} \\
 \text{tr}(Q_0 A_0^i Q_0) & \iff & M_{i+1} \quad i = 0, \dots, N-1 \\
 \text{tr}(Q_0 A_0^i F_0) & & O_{N-i} \quad i = 0, \dots, N-1
 \end{array}
 \tag{3.12}$$

In the repackaged form, the mapping becomes: $\text{tr}(q A^a q) \iff \mu^{a+1}$, $a = 0, \dots, N-1$.

3.2.2 $SU(M)$ with $\square, \overline{\square} + 3\square + 3\overline{\square}$ series

Odd rank: $M = 2N + 1$

The first series is $SU(2N + 1)$ gauge theory with fields in the antisymmetric and conjugate antisymmetric representation and $(3, 3)$ fundamentals, antifundamentals. The continuous global symmetry is $SU(3)_Q \times SU(3)_{\overline{Q}} \times U(1)^3$.

$$\begin{array}{c}
\mathcal{T}_1 : \\
\begin{array}{c}
\begin{array}{ccc}
& A & \tilde{A} \\
& \curvearrowright & \curvearrowleft \\
& \text{---} & \text{---} \\
& \curvearrowleft & \curvearrowright \\
& \text{---} & \text{---} \\
& Q & \tilde{Q} \\
& \swarrow & \searrow \\
\boxed{3} & & \boxed{3}
\end{array} \\
\text{---} \\
\boxed{2N+1} \\
\text{---} \\
\boxed{3} \quad \boxed{3}
\end{array}
\end{array}
\quad \mathcal{W} = 0
\tag{3.13}$$

The chiral ring generators are

- $Q(A\tilde{A})^k \tilde{Q} \sim Q_i^{\alpha_1} (\tilde{A}_{\alpha_1 \alpha_2} A^{\alpha_2 \alpha_3} \tilde{A}_{\alpha_3 \alpha_4} \dots A^{\alpha_{2k} \alpha_{2k+1}}) \tilde{Q}_{\alpha_{2k+1}}^I$ ⁷, $k = 0, \dots, N-1$
(transforming in the $(\bar{\square}, \square)$ of $SU(3)_Q \times SU(3)_{\tilde{Q}}$)
- $\tilde{A}(A\tilde{A})^k Q^2 \sim \tilde{A}_{\alpha_1 \alpha_2} (A^{\alpha_2 \alpha_3} \tilde{A}_{\alpha_3 \alpha_4} A^{\alpha_4 \alpha_5} \dots A^{\alpha_{2k+1} \alpha_{2k+2}} \tilde{A}_{\alpha_{2k+2} \alpha_{2k+3}}) Q_{[i}^{\alpha_{2k+3}} Q_{j]}^{\alpha_1}$,
 $k = 0, \dots, N-1 \sim (\bar{\square}, 1)$
- $A(A\tilde{A})^k \tilde{Q}^2 \sim A^{\alpha_1 \alpha_2} (\tilde{A}_{\alpha_2 \alpha_3} A^{\alpha_3 \alpha_4} \tilde{A}_{\alpha_4 \alpha_5} \dots \tilde{A}_{\alpha_{2k+1} \alpha_{2k+2}} A^{\alpha_{2k+2} \alpha_{2k+3}}) \tilde{Q}_{\alpha_{2k+3}}^I \tilde{Q}_{\alpha_1}^J$,
 $k = 0, \dots, N-1 \sim (1, \square)$
- $(A\tilde{A})^m \sim A^{\alpha_1 \alpha_2} \tilde{A}_{\alpha_2 \alpha_3} A^{\alpha_3 \alpha_4} \dots A^{\alpha_{2m-1} \alpha_{2m}} \tilde{A}_{\alpha_{2m} \alpha_1}$ $m = 1, \dots, N \sim (1, 1)$
- $\varepsilon_{2N+1} (A^N Q) \sim \varepsilon_{2N+1} (A^{\alpha_1 \alpha_2} \dots A^{\alpha_{2N-1} \alpha_{2N}} Q_i^{\alpha_{2N+1}}) \sim (\bar{\square}, 1)$
- $\varepsilon^{2N+1} (\tilde{A}^N \tilde{Q}) \sim \varepsilon^{2N+1} (\tilde{A}_{\alpha_1 \alpha_2} \dots \tilde{A}_{\alpha_{2N-1} \alpha_{2N}} Q_{\alpha_{2N+1}}^I) \sim (1, \square)$
- $\varepsilon_{2N+1} (A^{N-1} Q^3) \sim \varepsilon_{2N+1} \varepsilon^{ijk} (A^{\alpha_1 \alpha_2} \dots A^{\alpha_{2N-3} \alpha_{2N-2}} Q_i^{\alpha_{2N-1}} Q_j^{\alpha_{2N}} Q_k^{\alpha_{2N+1}}) \sim (1, 1)$
- $\varepsilon^{2N+1} (\tilde{A}^{N-1} \tilde{Q}^3) \sim \varepsilon^{2N+1} \varepsilon_{IJK} (\tilde{A}_{\alpha_1 \alpha_2} \dots \tilde{A}_{\alpha_{2N-3} \alpha_{2N-2}} \tilde{Q}_{\alpha_{2N-1}}^I \tilde{Q}_{\alpha_{2N}}^J Q_{\alpha_{2N+1}}^K) \sim (1, 1)$

We deconfine the two antisymmetric fields with the help of (2.107).

$$\begin{array}{c}
\mathcal{T}_{1'} : \\
\begin{array}{ccc}
\begin{array}{ccc}
\begin{array}{ccc}
& \boxed{1} & \\
& \swarrow & \searrow \\
& l & \tilde{c} \\
& \swarrow & \searrow \\
\boxed{2N-2} & & \boxed{2N+1} \\
& \swarrow & \searrow \\
& b & \tilde{b} \\
& \swarrow & \searrow \\
& Q & \tilde{Q} \\
& \swarrow & \searrow \\
\boxed{3} & & \boxed{3}
\end{array} \\
\text{---} \\
\boxed{2N-2} \\
\text{---} \\
\boxed{3} \quad \boxed{3}
\end{array} \\
\text{---} \\
\boxed{2N+1} \\
\text{---} \\
\boxed{3} \quad \boxed{3}
\end{array}
\end{array}
\quad \mathcal{W} = 2 \text{ Planar Triangles}
\tag{3.14}$$

⁷ $\alpha_i = 1, \dots, 2N+1$ are gauge indices. $I, J, \dots = 1, \dots, 3$ are $SU(3)_{\tilde{Q}}$ flavor indices. $i, j, k, l, \dots = 1, \dots, 3$ are $SU(3)_Q$ flavor indices.

Now we confine the SU node with (2.87).

\mathcal{T}_2 :

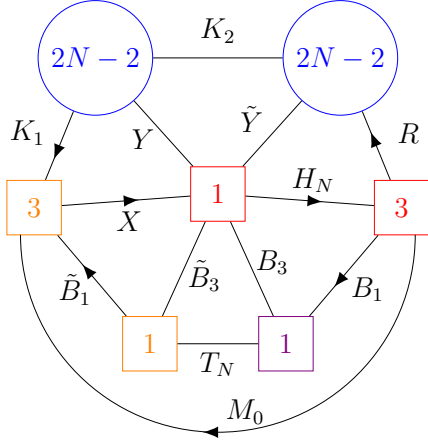

$$\begin{aligned}
\mathcal{W} = & \varepsilon_{2N-2} \varepsilon^{2N-2} \varepsilon_3 \varepsilon^3 \left[K_2^{2N-2} M_0^3 T_N \right. \\
& + K_2^{2N-2} M_0^2 B_1 \tilde{B}_1 + K_2^{2N-3} K_1 R M_0^2 T_N \\
& + K_2^{2N-3} K_1 R M_0 B_1 \tilde{B}_1 \\
& + K_2^{2N-4} K_1^2 R^2 M_0 T_N + K_2^{2N-4} K_1^2 R^2 B_1 \tilde{B}_1 \\
& \left. + K_2^{2N-5} K_1^3 R^3 T_N \right] + X H_N M_0 \\
& + 6 \text{ Planar Triangles}
\end{aligned} \tag{3.15}$$

Let us give more details. The first 7 terms in the superpotential (3.15) come from the determinant of the meson matrix Φ

$$\det \Phi \equiv \det \begin{pmatrix} K_2 & K_1 & 0 \\ R & M_0 & B_1 \\ 0 & \tilde{B}_1 & T_N \end{pmatrix} = \varepsilon^{a_1 \dots a_{2N+4}} \varepsilon_{b_1 \dots b_{2N+4}} \Phi_{a_1}^{b_1} \dots \Phi_{a_{2N+4}}^{b_{2N+4}}$$

$$\begin{aligned}
\longrightarrow & \varepsilon^{2N-2} \varepsilon_{2N-2} \varepsilon^3 \varepsilon_3 \left[K_2^{2N-2} \left(M_0^3 T_N + M_0^2 B_1 \tilde{B}_1 \right) + K_2^{2N-3} \left(K_1 R M_0^2 T_N \right. \right. \\
& \left. \left. + K_1 R M_0 B_1 \tilde{B}_1 \right) + K_2^{2N-4} \left(K_1^2 R^2 M_0 T_N + K_1^2 R^2 B_1 \tilde{B}_1 \right) + K_2^{2N-5} K_1^3 R^3 T_N \right]
\end{aligned} \tag{3.16}$$

The “ $X H_N M_0 + 6$ Planar Triangles” terms come from the cubic interaction “meson \times baryon \times meson” when the SU group confines. We also rescale the fields such that the coefficient in front of each term is +1.

The next step is to confine the left $Usp(2N-2)$ using (2.88).

\mathcal{T}_3 :

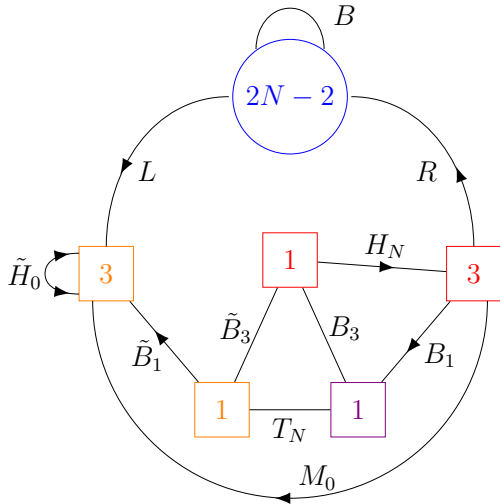

$$\begin{aligned}
\mathcal{W} = & \varepsilon_3 \varepsilon^3 \varepsilon_{2N-2} \left[B^{N-1} M_0^3 T_N \right. \\
& + B^{N-1} M_0^2 \tilde{B}_1 B_1 + B^{N-2} L R M_0^2 T_N \\
& + B^{N-2} L R M_0 \tilde{B}_1 B_1 + B^{N-2} \tilde{H}_0 R^2 M_0 T_N \\
& + B^{N-3} L^2 R^2 M_0 T_N + B^{N-2} \tilde{H}_0 R^2 B_1 \tilde{B}_1 \\
& + B^{N-3} L^2 R^2 B_1 \tilde{B}_1 + B^{N-3} \tilde{H}_0 L R^3 T_N \\
& \left. + B^{N-4} L^3 R^3 T_N \right] + T_N B_3 \tilde{B}_3 + B_1 H_N B_3 \\
& + \varepsilon_3 \varepsilon_{2N-2} \left[B^{N-1} \tilde{H}_0 \tilde{B}_1 \tilde{B}_3 + B^{N-1} \tilde{H}_0 M_0 H_N + B^{N-2} L^2 \tilde{B}_1 \tilde{B}_3 \right. \\
& \left. + B^{N-2} L^2 M_0 H_N + B^{N-2} L \tilde{H}_0 R H_N + B^{N-3} L^3 R H_N \right]
\end{aligned} \tag{3.17}$$

Let us explain how to get the superpotential in (3.17). The first 7 terms in (3.15) are mapped to the first 10 terms in (3.17). The additional 3 terms come from

- $\varepsilon^{2N-2} \varepsilon_{2N-2} (K_2^{2N-4} K_1^2 R^2 M_0 T_N) \longrightarrow \varepsilon_{2N-2} (B^{N-2} \tilde{H}_0 R^2 M_0 T_N + B^{N-3} L^2 R^2 M_0 T_N)$
- $\varepsilon^{2N-2} \varepsilon_{2N-2} (K_2^{2N-4} K_1^2 R^2 B_1 \tilde{B}_1) \longrightarrow \varepsilon_{2N-2} (B^{N-2} \tilde{H}_0 R^2 B_1 \tilde{B}_1 + B^{N-3} L^2 R^2 B_1 \tilde{B}_1)$
- $\varepsilon^{2N-2} \varepsilon_{2N-2} (K_2^{2N-5} K_1^3 R^3 T_N) \longrightarrow \varepsilon_{2N-2} (B^{N-3} \tilde{H}_0 L R^3 T_N + B^{N-4} L^3 R^3 T_N)$

Then X and \tilde{Y} of (3.15) get massive from the planar triangles terms. Indeed we obtain the following mass terms: $P_1 X$ and $P_2 \tilde{Y}$ where P_1 is the meson $[K_1 Y]$ and P_2 the meson $[K_2 Y]$ in the frame \mathcal{T}_2 . Therefore after integrating out massive fields, we are left with only two ‘‘triangles terms’’: $T_N B_3 \tilde{B}_3 + B_1 H_N B_3$.

The remaining terms come from the Pfaffian confining superpotential (2.88)

$$\begin{aligned} \text{Pfaff } \phi \equiv \text{Pfaff} \begin{pmatrix} B & L & P_2 \\ & \tilde{H}_0 & P_1 \\ & & 0 \end{pmatrix} &\sim \varepsilon_{a_1 \dots a_{2N+2}} \phi^{a_1 a_2} \dots \phi^{a_{2N+1} a_{2N+2}} \\ &\longrightarrow \varepsilon_3 \varepsilon_{2N-2} \left[B^{N-1} \tilde{H}_0 P_1 + B^{N-2} (L^2 P_1 + L \tilde{H}_0 P_2) + B^{N-3} L^3 P_2 \right] \end{aligned} \quad (3.18)$$

As we said P_1 and P_2 are massive fields and their expression are obtained by the E.O.M of X and \tilde{Y} . We get (after rescaling fields)

$$\begin{aligned} \text{E.O.M: from } X : P_1 &= \tilde{B}_1 \tilde{B}_3 + M_0 H_N \\ \text{from } \tilde{Y} : P_2 &= R H_N \end{aligned}$$

Putting all together, we get the superpotential written in (3.17).

The next step is to confine the $Usp(2N-2)$ node using the result (3.11). In order to apply it and get a superpotential in a close form, we need to flip the tower of traces of the antisymmetric field B . Using the mapping (3.19), it amounts to flip in the frame \mathcal{T}_1 the tower of $(A \tilde{A})^j$. To simplify even further we also flip the two singlets $\varepsilon_{2N+1} (A^{N-1} Q^3)$ and $\varepsilon_{2N+1} (\tilde{A}^{N-1} \tilde{Q}^3)$. Therefore we kill terms with T_N, B_3 and \tilde{B}_3 .

\mathcal{T}_1	\mathcal{T}_1'	\mathcal{T}_2	\mathcal{T}_3	
$Q \tilde{Q}$	$Q \tilde{Q}$	M_0	M_0	
$Q (A \tilde{A})^j \tilde{Q}$	$Q (bb \tilde{b}\tilde{b})^j \tilde{Q}$	$R K_2 (K_2 K_2)^{j-1} K_1$	$L B^{j-1} R$	$j = 1, \dots, N-1$
$\tilde{A} (A \tilde{A})^i Q^2$	$\tilde{b}\tilde{b} (bb \tilde{b}\tilde{b})^i Q^2$	$R (K_2 K_2)^i R$	$R B^i R$	$i = 0, \dots, N-2$
$\tilde{A} (A \tilde{A})^{N-1} Q^2$	$\varepsilon_{2N+1} ((bb)^{N-1} c Q^2)$	H_N	H_N	
$A \tilde{Q}^2$	$bb \tilde{Q}^2$	$K_1 K_1$	\tilde{H}_0	
$A (A \tilde{A})^k \tilde{Q}^2$	$bb (bb \tilde{b}\tilde{b})^k \tilde{Q}^2$	$K_1 (K_2 K_2)^k K_1$	$L B^{k-1} L$	$k = 1, \dots, N-2$
$A (A \tilde{A})^{N-1} \tilde{Q}^2$	$\varepsilon_{2N+1} ((\tilde{b}\tilde{b})^{N-1} \tilde{c} \tilde{Q}^2)$	X	$\tilde{H}_0 B^{N-1} + L B^{N-2} L$	
$(A \tilde{A})^m$	$(bb \tilde{b}\tilde{b})^m$	$(K_2 K_2)^m$	B^m	$m = 1, \dots, N-1$
$(A \tilde{A})^N$	$c \tilde{c}$	T_N	T_N	
$\varepsilon_{2N+1} (A^N Q)$	$\tilde{c} Q$	B_1	B_1	
$\varepsilon_{2N+1} (\tilde{A}^N \tilde{Q})$	$c \tilde{Q}$	\tilde{B}_1	\tilde{B}_1	
$\varepsilon_{2N+1} (A^{N-1} Q^3)$	$\varepsilon_{2N+1} ((bb)^{N-1} Q^3)$	B_3	B_3	
$\varepsilon_{2N+1} (\tilde{A}^{N-1} \tilde{Q}^3)$	$\varepsilon_{2N+1} ((\tilde{b}\tilde{b})^{N-1} \tilde{Q}^3)$	\tilde{B}_3	\tilde{B}_3	

(3.19)

The summary of this flipping procedure is the following duality

$\mathcal{T}_{1,flip} :$

$\mathcal{W} = \sum_{i=1}^N \text{Flip}[(A \tilde{A})^i] +$
 $+ \text{Flip}[\varepsilon_{2N+1} \varepsilon^3 [A^{N-1} Q^3]] +$
 $+ \text{Flip}[\varepsilon^{2N+1} \varepsilon_3 [\tilde{A}^{N-1} \tilde{Q}^3]]$

$\mathcal{T}_{3,flip} :$

$\mathcal{W} = \varepsilon_3 \varepsilon^3 \varepsilon_{2N-2} \left[B^{N-1} M_0^2 \tilde{B}_1 B_1 + B^{N-2} L R M_0 \tilde{B}_1 B_1 \right.$
 $+ B^{N-2} \tilde{H}_0 R^2 B_1 \tilde{B}_1 + B^{N-3} L^2 R^2 B_1 \tilde{B}_1 + B^{N-1} \tilde{H}_0 M_0 H_N$
 $\left. + B^{N-2} L^2 M_0 H_N + B^{N-2} L \tilde{H}_0 R H_N + B^{N-3} L^3 R H_N \right] + \sum_{i=2}^{N-1} \text{Flip}[B^i]$

(3.20)

We can now use our confining result of Section 3.2.1. We rewrite (3.11) after splitting the 6 fundamentals into two groups of 3, getting

B

$\mathcal{W} = \sum_{i=2}^M \text{Flip}[B^i]$

\Leftrightarrow

$\mathcal{W} = \sum_{i,j,k=1}^M \varepsilon_3 \varepsilon^3 \left(\tilde{H}_i M_j H_k + M_i M_j M_k \right) \delta_{i+j+k, 2M+1}$

$\text{tr}(L B^k L) \longleftrightarrow \tilde{H}_{k+1}$
 $\text{tr}(R B^k R) \longleftrightarrow H_{k+1} \quad k = 0, \dots, M-1$
 $\text{tr}(L B^k R) \longleftrightarrow M_{k+1}$

(3.21)

Apply this result to our frame $\mathcal{T}_{3,flip}$ in (3.20) we get the final WZ

$\mathcal{T}_{4,flip}$:

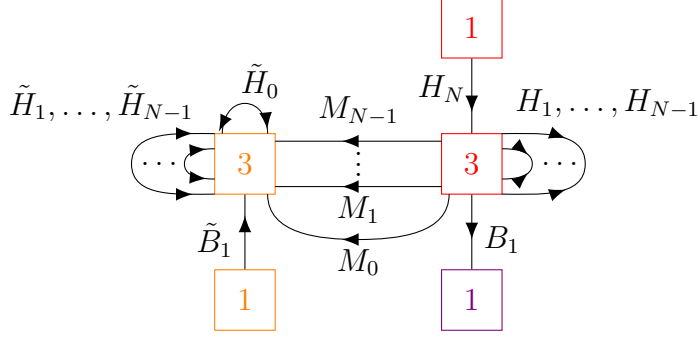

$$\begin{aligned}
\mathcal{W} = \varepsilon_3 \varepsilon^3 & \left[M_{N-1} M_0 \tilde{B}_1 B_1 + \sum_{l=0}^{N-3} \left(\tilde{H}_{l+1} H_{N-2-l} B_1 \tilde{B}_1 + M_{l+1} M_{N-2-l} B_1 \tilde{B}_1 \right) \right. \\
& + H_{N-1} \tilde{H}_0 B_1 \tilde{B}_1 + \tilde{H}_{N-1} M_0 H_N + \tilde{H}_0 M_{N-1} H_N + \sum_{l=0}^{N-3} \left(\tilde{H}_{l+1} M_{N-2-l} H_N \right) \\
& \left. + \sum_{i,j,k=1}^{N-1} \left(\tilde{H}_i M_j H_k + M_i M_j M_k \right) \delta_{i+j+k, 2N-1} \right] \tag{3.22}
\end{aligned}$$

As a consistency check, for $N = 2$ we recover the superpotential given in [46] Section 3.1.4. The mapping of the chiral ring in the flipping case is

$\mathcal{T}_{1,flip}$	$\mathcal{T}_{3,flip}$	$\mathcal{T}_{4,flip}$	
$Q \tilde{Q}$	M_0	M_0	
$Q (A \tilde{A})^j \tilde{Q}$	$L B^{j-1} R$	M_j	$j = 1, \dots, N-1$
$\tilde{A} (A \tilde{A})^i Q^2$	$R B^i R$	H_{i+1}	$i = 0, \dots, N-2$
$\tilde{A} (A \tilde{A})^{N-1} Q^2$	H_N	H_N	
$A \tilde{Q}^2$	\tilde{H}_0	\tilde{H}_0	
$A (A \tilde{A})^k \tilde{Q}^2$	$L B^{k-1} L$	\tilde{H}_k	$k = 1, \dots, N-2$
$A (A \tilde{A})^{N-1} \tilde{Q}^2$	$L B^{N-2} L$	\tilde{H}_{N-1}	
$\varepsilon_{2N+1} (A^N Q)$	B_1	B_1	
$\varepsilon_{2N+1} (\tilde{A}^N \tilde{Q})$	\tilde{B}_1	\tilde{B}_1	

Even rank: $M = 2N$

Let us now study the even rank case of the previous gauge theory.

\mathcal{T}_1 :

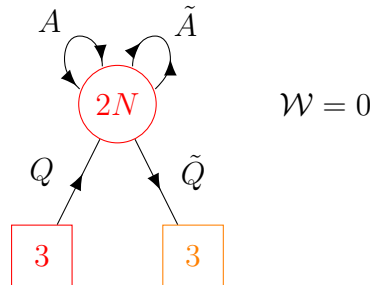

$$(3.24)$$

The chiral ring generators are

- $Q(A\tilde{A})^k\tilde{Q} \sim Q_i^{\alpha_1}(\tilde{A}_{\alpha_1\alpha_2} A^{\alpha_2\alpha_3} \tilde{A}_{\alpha_3\alpha_4} \dots A^{\alpha_{2k}\alpha_{2k+1}}) \tilde{Q}_{\alpha_{2k+1}}^I$, $k = 0, \dots, N-1$
(transforming in the $(\bar{\square}, \square)$ of $SU(3)_Q \times SU(3)_{\tilde{Q}}$)
- $\tilde{A}(A\tilde{A})^k Q^2 \sim \tilde{A}_{\alpha_1\alpha_2}(A^{\alpha_2\alpha_3} \tilde{A}_{\alpha_3\alpha_4} A^{\alpha_4\alpha_5} \dots A^{\alpha_{2k+1}\alpha_{2k+2}} \tilde{A}_{\alpha_{2k+2}\alpha_{2k+3}}) Q_{[i}^{\alpha_{2k+3}} Q_{j]}^{\alpha_1}$,
 $k = 0, \dots, N-1 \sim (\bar{\square}, 1)$
- $A(A\tilde{A})^k \tilde{Q}^2 \sim A^{\alpha_1\alpha_2}(\tilde{A}_{\alpha_2\alpha_3} A^{\alpha_3\alpha_4} \tilde{A}_{\alpha_4\alpha_5} \dots \tilde{A}_{\alpha_{2k+1}\alpha_{2k+2}} A^{\alpha_{2k+2}\alpha_{2k+3}}) \tilde{Q}_{\alpha_{2k+3}}^{[I} \tilde{Q}_{\alpha_1}^{J]}$,
 $k = 0, \dots, N-1 \sim (1, \square)$
- $(A\tilde{A})^m \sim (A^{\alpha_1\alpha_2} \tilde{A}_{\alpha_2\alpha_3} \dots A^{\alpha_{2m-1}\alpha_{2m}} \tilde{A}_{\alpha_{2m}\alpha_1})$, $m = 1, \dots, N-1 \sim (1, 1)$
- $\varepsilon_{2N} A^N \sim \varepsilon_{2N} (A^{\alpha_1\alpha_2} \dots A^{\alpha_{2N-1}\alpha_{2N}}) \sim (1, 1)$
- $\varepsilon_{2N} \tilde{A}^N \sim \varepsilon_{2N} (\tilde{A}_{\alpha_1\alpha_2} \dots \tilde{A}_{\alpha_{2N-1}\alpha_{2N}}) \sim (1, 1)$
- $\varepsilon_{2N} (A^{N-1} Q^2) \sim \varepsilon_{2N} (A^{\alpha_1\alpha_2} \dots A^{\alpha_{2N-3}\alpha_{2N-2}} Q_{[i}^{\alpha_{2N-1}} Q_{j]}^{\alpha_{2N}}) \sim (\bar{\square}, 1)$
- $\varepsilon_{2N} (\tilde{A}^{N-1} \tilde{Q}^2) \sim \varepsilon_{2N} (\tilde{A}_{\alpha_1\alpha_2} \dots \tilde{A}_{\alpha_{2N-3}\alpha_{2N-2}} \tilde{Q}_{\alpha_{2N-1}}^{[I} \tilde{Q}_{\alpha_{2N}}^{J]}) \sim (1, \square)$

The next step is to deconfine the antisymmetric and the conjugate antisymmetric fields. To do so we use a variant of the deconfinement method (2.103), where we don't have to split the flavor symmetry. By doing so we don't have to split the chiral ring generators and it is then easier.

$\mathcal{T}_{1'}$:

$\mathcal{W} = 4 \text{ Planar Triangles}$
 $+ \text{Flip}[K_1 K_1] + \text{Flip}[R R]$

(3.25)

Then we confine the SU node with (2.87).

\mathcal{T}_2 :

$\mathcal{W} = \text{Flip}[K_1 K_1] + \text{Flip}[R R]$
 $+ \varepsilon_{2N} \varepsilon^{2N} [K_2^{2N-1} K_1 R B_2 \tilde{B}_2$
 $+ K_2^{2N} \alpha_N] + B_0 B_2 K_1 X$
 $+ \tilde{B}_0 \tilde{B}_2 R \tilde{X} + X \tilde{X} K_2$
 $+ \tilde{B}_0 B_0 \alpha_N$

(3.26)

Once again some terms in the superpotential in (3.26) come from the determinant of the $(2N + 1) \times (2N + 1)$ meson matrix Φ

$$\begin{aligned} \det \Phi &\equiv \det \begin{pmatrix} K_2 & (b\tilde{c}) \\ (c\tilde{b}) & \alpha_N \end{pmatrix} = \varepsilon^{a_1 \dots a_{2N+1}} \varepsilon_{b_1 \dots b_{2N+1}} \Phi_{a_1}^{b_1} \dots \Phi_{a_{2N+1}}^{b_{2N+1}} \\ &\longrightarrow \varepsilon^{2N} \varepsilon_{2N} \left[K_2^{2N-1} (b\tilde{c})(c\tilde{b}) + K_2^{2N} \alpha_N \right] \end{aligned} \quad (3.27)$$

$(b\tilde{c})$ and $(c\tilde{b})$ are massive fields and their expressions are obtained by the E.O.M of d and \tilde{d} from \mathcal{T}_1'

$$\begin{aligned} \text{E.O.M: from } d : (b\tilde{c}) &= K_1 B_2 \\ \text{from } \tilde{d} : (c\tilde{b}) &= R \tilde{B}_2 \end{aligned}$$

Then we confine the left $Usp(2N)$ node with (2.88) to get

\mathcal{T}_3 :

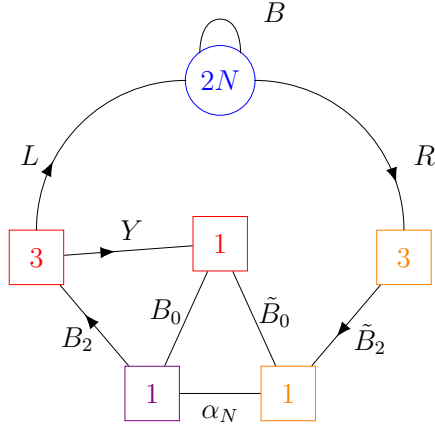

$$\begin{aligned} \mathcal{W} &= \text{Flip}[RR] + \alpha_N \text{tr} (B^N) \\ &+ Y B_0 B_2 + \tilde{B}_0 B_0 \alpha_N \\ &+ \varepsilon_{2N} \left(B^{N-1} L B_2 R \tilde{B}_2 \right) \\ &+ \varepsilon_{2N} \varepsilon^3 \left[B^{N-1} L^2 Y \right. \\ &\quad \left. + B^{N-2} L^3 R \tilde{B}_2 \tilde{B}_0 \right] \end{aligned} \quad \tilde{n}$$

(3.28)

We notice that the fields n and \tilde{X} get a mass. To obtain (3.28) from (3.26) we have to compute the Pfaffian of the following $(2N + 4) \times (2N + 4)$ antisymmetric matrix

$$\text{Pfaff } \phi \equiv \text{Pfaff} \begin{pmatrix} B & L & (K_2 X) \\ (K_1 K_1) & (K_1 X) & \\ & & 0 \end{pmatrix} \sim \varepsilon_{a_1 \dots a_{2N+4}} \phi^{a_1 a_2} \dots \phi^{a_{2N+3} a_{2N+4}} \quad (3.29)$$

$$\begin{aligned} \text{E.O.M: from } n : (K_1 K_1) &= 0 \\ \text{from } \tilde{X} : (K_2 X) &= [R \tilde{B}_2] \tilde{B}_0 \end{aligned}$$

$$\longrightarrow \varepsilon_{2N} \varepsilon^3 \left[B^{N-1} L^2 Y + B^{N-2} L^3 (K_2 X) \right] \quad (3.30)$$

All in all we get (3.28). The next step is to confine the $Usp(2N - 2)$ node using the result (3.11). Therefore we have to flip the whole tower of $\text{tr} (B^k)$. Notice that the last one $\text{tr} (B^N)$ is already flipped by α_N . We also flip \tilde{B}_0 and B_0 because we do not want the flipper α_N to appear elsewhere in the superpotential. By doing so we kill 3 terms in the superpotential of (3.28) : $Y B_0 B_2, \tilde{B}_0 B_0 \alpha_N, \varepsilon_{2N} \varepsilon^3 (B^{N-2} L^3 R \tilde{B}_2 \tilde{B}_0)$.

Using the mapping (3.31) we see that in the original frame it amounts to flip the tower of $(A \tilde{A})^k, k = 1, \dots, N-1$ and also $\varepsilon_{2N} A^N, \varepsilon_{2N} \tilde{A}^N$.

\mathcal{T}_1	\mathcal{T}_1	\mathcal{T}_2	\mathcal{T}_3	
$Q(A\tilde{A})^k\tilde{Q}$	$K_1 b (bb\tilde{b}\tilde{b})^k R\tilde{b}$	$K_1 K_2 (K_2 K_2)^k R$	$L B^k R$	$k = 0, \dots, N-1$
$(A\tilde{A})^n$	$(bb\tilde{b}\tilde{b})^n$	$(K_2 K_2)^n$	B^n	$n = 1, \dots, N-1$
$\tilde{A}(A\tilde{A})^m Q^2$	$\tilde{b}\tilde{b}(bb\tilde{b}\tilde{b})^m (K_1 b)^2$	$K_1 (K_2 K_2)^{m+1} K_1$	$L B^m L$	$m = 0, \dots, N-2$
$A(A\tilde{A})^m \tilde{Q}^2$	$bb(bb\tilde{b}\tilde{b})^m (R\tilde{b})^2$	$R(K_2 K_2)^{m+1} R$	$R B^{m+1} R$	$m = 0, \dots, N-2$
$\varepsilon_{2N} A^N$	$\varepsilon_{2N} (bb)^N$	B_0	B_0	
$\varepsilon_{2N} \tilde{A}^N$	$\varepsilon_{2N} (\tilde{b}\tilde{b})^N$	\tilde{B}_0	\tilde{B}_0	
$\varepsilon_{2N} (A^{N-1} Q^2)$	B_2	B_2	B_2	
$\varepsilon_{2N} (\tilde{A}^{N-1} \tilde{Q}^2)$	\tilde{B}_2	\tilde{B}_2	\tilde{B}_2	

(3.31)

The summary of this flipping procedure is the following duality

$\mathcal{T}_{1,flip} :$

$\mathcal{W} = \sum_{i=1}^{N-1} \text{Flip}[(A\tilde{A})^i]$
 $+ \text{Flip}[\varepsilon_{2N} A^N] + \text{Flip}[\varepsilon_{2N} \tilde{A}^N]$

$\mathcal{T}_{3,flip} :$

$\mathcal{W} = \text{Flip}[RR] + \varepsilon_{2N} (B^{N-1} L R B_2 \tilde{B}_2)$
 $+ \varepsilon_{2N} \varepsilon^3 (B^{N-1} L^2 Y) + \sum_{i=2}^N \text{Flip}[B^i]$

(3.32)

The final step is to confine the $Usp(2N)$ using the result from (3.21). The WZ is

$\mathcal{T}_{4,flip} :$

$\mathcal{W} = \tilde{B}_2 B_2 M_N + \sum_{i,j,k=1}^N \varepsilon_3 \varepsilon^3 \left(\tilde{H}_i M_j H_k + M_i M_j M_k \right) \delta_{i+j+k, 2N+1} \Big|_{H_N = \tilde{H}_1 = 0}$

(3.33)

The fields \tilde{H}_1 and H_N have been set to 0 by the E.O.M of Y and \tilde{n} . It kills N terms in the sum. As a consistency check, for $N = 2$ we recover the superpotential given in [46] Sec.3.1.5.

The mapping of the chiral ring in the flipping case is

$$\begin{array}{ccc}
\mathcal{T}_{1,flip} & & \mathcal{T}_{3,flip} & & \mathcal{T}_{4,flip} & & \\
Q(A\tilde{A})^k\tilde{Q} & & LB^kR & & M_{k+1} & & k=0,\dots,N-1 \\
\tilde{A}(A\tilde{A})^mQ^2 & \iff & LB^mL & \iff & H_{m+1} & & m=0,\dots,N-2 \\
A(A\tilde{A})^m\tilde{Q}^2 & & RB^{m+1}R & & \tilde{H}_{m+2} & & m=0,\dots,N-2 \\
\varepsilon_{2N}(A^{N-1}Q^2) & & B_2 & & B_2 & & \\
\varepsilon_{2N}(\tilde{A}^{N-1}\tilde{Q}^2) & & \tilde{B}_2 & & \tilde{B}_2 & &
\end{array} \tag{3.34}$$

3.2.3 $SU(M)$ with $\begin{smallmatrix} \square \\ \square \end{smallmatrix} + M\overline{\square} + 4\square$ series

Odd rank: $M = 2N + 1$

The gauge theory is $SU(2N + 1)$ with one antisymmetric field, $2N + 1$ antifundamentals and 4 fundamentals, with continuous global symmetry $SU(2N + 1)_{\tilde{Q}} \times SU(4)_Q \times U(1)^2$.

$$\begin{array}{c}
\mathcal{T}_1 : \\
\begin{array}{ccc}
& \begin{array}{c} \curvearrowright A \\ \curvearrowleft \end{array} \\
& \begin{array}{c} \textcircled{2N+1} \\ \tilde{Q} \swarrow \quad \searrow Q \\ \begin{array}{cc} \square_{2N+1} & \square_4 \end{array} \end{array} \\
& \mathcal{W} = 0
\end{array} \tag{3.35}
\end{array}$$

The chiral ring generators are

- $Q\tilde{Q} \sim Q_i^\alpha \tilde{Q}_\alpha^I$ (transforming in the $(\square, \overline{\square})$ of $SU(2N + 1)_{\tilde{Q}} \times SU(4)_Q$)
- $A\tilde{Q}^2 \sim A^{\alpha\beta} \tilde{Q}_\alpha^{[I} \tilde{Q}_\beta^{J]} \sim (\begin{smallmatrix} \square \\ \square \end{smallmatrix}, 1)$
- $A^N Q \sim \varepsilon_{\alpha_1 \dots \alpha_{2N+1}} A^{\alpha_1 \alpha_2} \dots A^{\alpha_{2N-1} \alpha_{2N}} Q_i^{\alpha_{2N+1}} \sim (1, \overline{\square})$
- $A^{N-1} Q^3 \sim \varepsilon_{\alpha_1 \dots \alpha_{2N+1}} \varepsilon^{ijkl} A^{\alpha_1 \alpha_2} \dots A^{\alpha_{2N-3} \alpha_{2N-2}} Q_i^{\alpha_{2N-1}} Q_j^{\alpha_{2N}} Q_k^{\alpha_{2N+1}} \sim (1, \square)$
- $\tilde{Q}^{2N+1} \sim \varepsilon^{\alpha_1 \dots \alpha_{2N+1}} \varepsilon_{I_1 \dots I_{2N+1}} \tilde{Q}_{\alpha_1}^{I_1} \dots \tilde{Q}_{\alpha_{2N+1}}^{I_{2N+1}} \sim (1, 1)$

We deconfine the antisymmetric field using (2.107). We get

$$\begin{array}{c}
\mathcal{T}_{1'} : \\
\begin{array}{ccc}
\begin{array}{ccc}
\begin{array}{c} \textcircled{2N-2} \\ l \downarrow \\ \square_1 \end{array} & \xrightarrow{b} & \begin{array}{c} \textcircled{2N+1} \\ \tilde{c} \swarrow \quad \searrow Q \\ \begin{array}{cc} \square_{2N+1} & \square_4 \end{array} \end{array} \\
& \tilde{Q} \swarrow & \\
& & \square_{2N+1} \quad \square_4
\end{array} \\
\mathcal{W} = -1 \text{ Planar Triangle}
\end{array} \tag{3.36}
\end{array}$$

We then confine the SU gauge node using (2.87). The field l becomes massive. Then the determinant of the meson matrix is easily computed. We obtain

\mathcal{T}_2 :

$$\mathcal{W} = \varepsilon_{2N-2} \varepsilon_4 \varepsilon^{2N+1} (K^{2N-2} M^3 B_1) - 3 \text{ Planar Triangles} \quad (3.37)$$

We then S-confines the $Usp(2N-2)$ gauge node using (2.88). The result of the integration of the massive field Y and the computation of the Pfaffian superpotential is the following WZ model

\mathcal{T}_3 :

$$\mathcal{W} = \varepsilon^{2N+1} \varepsilon_4 (\tilde{H}^{N-1} B_1 M^3 - \tilde{H}^N M B_3) - \tilde{B} B_1 B_3 \quad (3.38)$$

We recover the result of Section 3.1.3 of [46]. The mapping of the chiral ring generators across the different frames is given in (3.39).

\mathcal{T}_1		$\mathcal{T}_{1'}$		\mathcal{T}_2		\mathcal{T}_3
$Q \tilde{Q}$		$Q \tilde{Q}$		M		M
$A \tilde{Q}^2$		$b b \tilde{Q}^2$		K^2		\tilde{H}
$\varepsilon_{2N+1} \tilde{Q}^{2N+1}$	\iff	$\varepsilon_{2N+1} \tilde{Q}^{2N+1}$	\iff	\tilde{B}	\iff	\tilde{B}
$\varepsilon_{2N+1} (A^N Q)$		$\tilde{c} Q$		B_1		B_1
$\varepsilon_{2N+1} (A^{N-1} Q^3)$		$\varepsilon_{2N+1} (b^{2N-2} Q^3)$		B_3		B_3

$$(3.39)$$

Even rank: $M = 2N$

Now we study the even rank version of the previous theory. The continuous global symmetry is $SU(2N)_{\tilde{Q}} \times SU(4)_Q \times U(1)^2$.

\mathcal{T}_1 :

$$(3.40)$$

We deconfine the antisymmetric using (2.103) which implies the breaking of the $SU(4)_Q$ into $SU(3)_q \times U(1)_F$. The chiral ring generators in the split form are

- $q\tilde{Q} \sim q_i^\alpha \tilde{Q}_\alpha^I$ (transforming in the $(\square, \bar{\square})$ of $SU(2N)_{\tilde{Q}} \times SU(3)_q$)
- $F\tilde{Q} \sim F^\alpha \tilde{Q}_\alpha^I \sim (\square, 1)$
- $A\tilde{Q}^2 \sim A^{\alpha\beta} \tilde{Q}_\alpha^I \tilde{Q}_\beta^J \sim (\square, 1)$
- $A^N \sim \varepsilon_{\alpha_1 \dots \alpha_{2N}} A^{\alpha_1 \alpha_2} \dots A^{\alpha_{2N-1} \alpha_{2N}} \sim (1, 1)$
- $A^{N-1} q^2 \sim \varepsilon_{\alpha_1 \dots \alpha_{2N}} A^{\alpha_1 \alpha_2} \dots A^{\alpha_{2N-3} \alpha_{2N-2}} q_{[i}^{\alpha_{2N-1}} q_{j]}^{\alpha_{2N}} \sim (1, \bar{\square})$
- $A^{N-1} q F \sim \varepsilon_{\alpha_1 \dots \alpha_{2N}} A^{\alpha_1 \alpha_2} \dots A^{\alpha_{2N-3} \alpha_{2N-2}} q_i^{\alpha_{2N-1}} F^{\alpha_{2N}} \sim (1, \bar{\square})$
- $A^{N-2} q^3 F \sim \varepsilon_{\alpha_1 \dots \alpha_{2N+1}} \varepsilon^{ijk} A^{\alpha_1 \alpha_2} \dots A^{\alpha_{2N-5} \alpha_{2N-4}} q_i^{\alpha_{2N-3}} q_j^{\alpha_{2N-2}} q_k^{\alpha_{2N-1}} F^{\alpha_{2N}} \sim (1, 1)$
- $\tilde{Q}^{2N} \sim \varepsilon^{\alpha_1 \dots \alpha_{2N}} \varepsilon_{I_1 \dots I_{2N}} \tilde{Q}_{\alpha_1}^{I_1} \dots \tilde{Q}_{\alpha_{2N}}^{I_{2N}} \sim (1, 1)$

\mathcal{T}_1 :

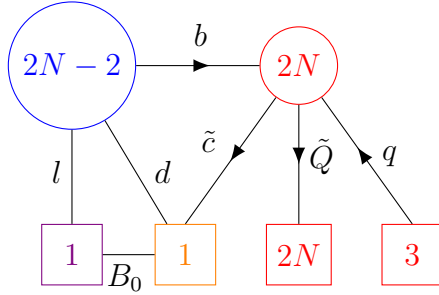

$$\mathcal{W} = \text{Plannar Triangle} - ldB_0$$

(3.41)

The next step is once again to confine the SU gauge group using (2.87).

\mathcal{T}_2 :

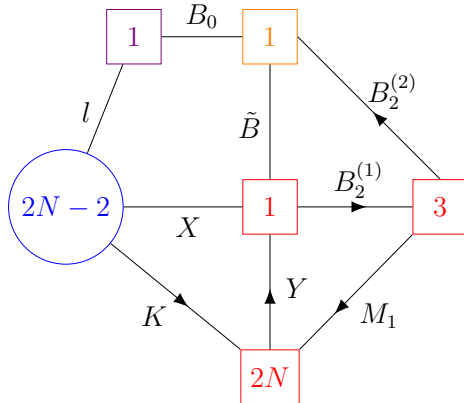

$$\begin{aligned} \mathcal{W} = & \varepsilon_{2N-2} \varepsilon^{2N} \varepsilon_3 \left(K^{2N-2} M_1^2 B_2^{(2)} \right. \\ & \left. - K^{2N-3} M_1^3 l B_0 \right) - B_0 \tilde{B} X l \\ & - 3 \text{ Planar Triangles} \end{aligned}$$

(3.42)

The last step is to confine the $Usp(2N-2)$. We get the following WZ theory

\mathcal{T}_3 :

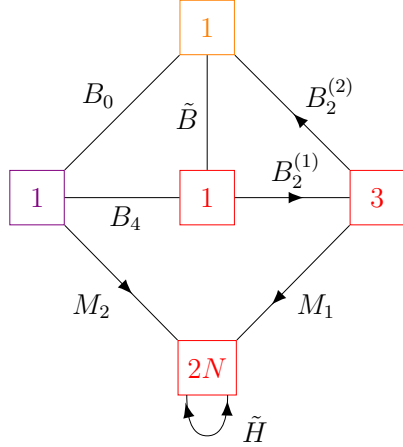

$$\begin{aligned} \mathcal{W} = \varepsilon^{2N} \varepsilon_3 & \left(\tilde{H}^N B_4 + \tilde{H}^{N-1} M_1^2 B_2^{(2)} \right. \\ & + \tilde{H}^{N-1} M_1 M_2 B_2^{(1)} - \tilde{H}^{N-2} M_1^3 M_2 B_0 \\ & \left. - \tilde{B} B_0 B_4 - \tilde{B} B_2^{(2)} B_2^{(1)} \right) \end{aligned} \quad (3.43)$$

The final superpotential can be repackaged in a manifest $SU(4)$ invariant way as

$$\mathcal{W} = \varepsilon^{2N} \varepsilon_4 \left(\tilde{H}^N B_4 + \tilde{H}^{N-1} M^2 B_2 - \tilde{H}^{N-2} M^4 B_0 - \tilde{B} B_0 B_4 - \tilde{B} B_2^2 \right), \quad (3.44)$$

where $Q\tilde{Q} \leftrightarrow M = \{M_1, M_2\}$ is a fundamental of $SU(4)_Q$ and $A^{N-1}Q^2 \leftrightarrow B_2 = \{\varepsilon_3 B_2^{(1)}, B_2^{(2)}\}$ is an antisymmetric of $SU(4)_Q$. We recover the result of Section 3.1.2 of [46]. The mapping of the chiral ring generators across the frames is given in (3.45).

\mathcal{T}_1		\mathcal{T}_1'		\mathcal{T}_2		\mathcal{T}_3
$q\tilde{Q}$		$q\tilde{Q}$		M_1		M_1
$F\tilde{Q}$		$lb\tilde{Q}$		lK		M_2
$A\tilde{Q}^2$		$bb\tilde{Q}^2$		K^2		\tilde{H}
$\varepsilon_{2N} \tilde{Q}^{2N}$	\iff	$\varepsilon_{2N} \tilde{Q}^{2N}$	\iff	\tilde{B}	\iff	\tilde{B}
$\varepsilon_{2N} A^N$		B_0		B_0		B_0
$\varepsilon_{2N} (A^{N-1} q^2)$		$\varepsilon_{2N} (b^{2N-2} q^2)$		$B_2^{(1)}$		$B_2^{(1)}$
$\varepsilon_{2N} (A^{N-1} q F)$		$\tilde{c} q$		$B_2^{(2)}$		$B_2^{(2)}$
$\varepsilon_{2N} (A^{N-2} q^3 F)$		$\varepsilon_{2N} (b^{2N-4} lbq^3)$		lX		B_4

3.2.4 Four 'sporadic' cases: $SU(5)$, $SU(6)$, $SU(7)$

In this section we show how the strategy of deconfining antisymmetric fields allow proving the remaining four S-confining cases in the list of [44, 46]. In the two $SU(5)$ cases, there are extra subtelties when computing the superpotential because of the presence of degenerate operators.

$SU(7)$ with $2 \begin{smallmatrix} \square \\ \square \end{smallmatrix} + 6 \overline{\square}$

The gauge theory is $SU(7)$ with two antisymmetric fields and 6 antifundamentals, with continuous global symmetry $SU(2)_A \times SU(6)_{\tilde{Q}} \times U(1)$.

$\mathcal{T}_1 :$

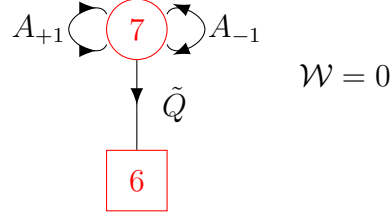

(3.46)

The chiral ring generators are

- $A\tilde{Q}^2 \sim A_i^{\alpha_1\alpha_2} \tilde{Q}_{\alpha_1}^I \tilde{Q}_{\alpha_2}^J$ ⁸ (transforming in the (\square, \square) of $SU(2)_A \times SU(6)_{\tilde{Q}}$).
- $\varepsilon_7 (A^4 \tilde{Q}) \sim \varepsilon_{\alpha_1 \dots \alpha_7} \varepsilon^{kl} A_i^{\alpha_1\alpha_2} A_j^{\alpha_3\alpha_4} A_k^{\alpha_5\alpha_6} A_l^{\alpha_7\beta} \tilde{Q}_\beta^I \sim (\square\square, \square)$

We will deconfine each antisymmetric field using (2.107). Notice that this step breaks the global $SU(2)_A$ symmetry into a $U(1)_A$. In (3.46), the subscript of the two antisymmetric fields, $A_{\pm 1}$ correspond to the $U(1)_A$ charge (corresponding to the weight of the representation of $SU(2)_A$). So let us give the chiral ring in this split form

- $A_{+1} \tilde{Q}^2 \sim A_{+1}^{\alpha_1\alpha_2} \tilde{Q}_{\alpha_1}^I \tilde{Q}_{\alpha_2}^J \sim \square$ of $SU(6)_{\tilde{Q}}$
- $A_{-1} \tilde{Q}^2 \sim A_{-1}^{\alpha_1\alpha_2} \tilde{Q}_{\alpha_1}^I \tilde{Q}_{\alpha_2}^J \sim \square$
- $\varepsilon_7 (A_{+1} A_{+1} A_{+1} A_{-1} \tilde{Q}) \sim \varepsilon_{\alpha_1 \dots \alpha_7} A_{+1}^{\alpha_1\alpha_2} A_{+1}^{\alpha_3\alpha_4} (A_{+1}^{\alpha_5\alpha_6} A_{-1}^{\alpha_7\beta} - A_{-1}^{\alpha_5\alpha_6} A_{+1}^{\alpha_7\beta}) \tilde{Q}_\beta^I \sim \square$
- $\varepsilon_7 (A_{(+1} A_{-1}) A_{(+1} A_{-1}) \tilde{Q}) \sim \varepsilon_{\alpha_1 \dots \alpha_7} A_{(+1}^{\alpha_1\alpha_2} A_{(-1)}^{\alpha_3\alpha_4} A_{(+1}^{\alpha_5\alpha_6} A_{(-1)}^{\alpha_7\beta} \tilde{Q}_\beta^I \sim \square$
- $\varepsilon_7 (A_{-1} A_{-1} A_{(+1} A_{-1}) \tilde{Q}) \sim \varepsilon_{\alpha_1 \dots \alpha_7} A_{(-1)}^{\alpha_1\alpha_2} A_{(-1)}^{\alpha_3\alpha_4} A_{(+1}^{\alpha_5\alpha_6} A_{(-1)}^{\alpha_7\beta} \tilde{Q}_\beta^I \sim \square$

$\mathcal{T}_{1'}$:

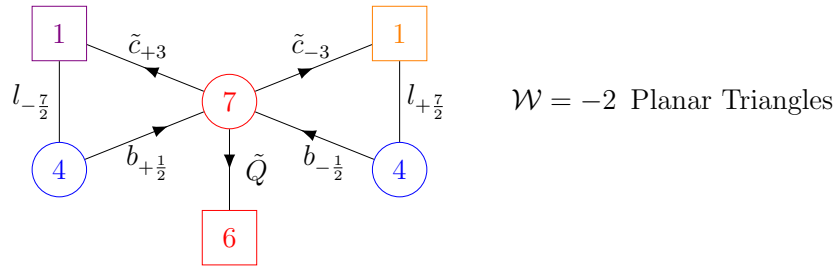

(3.47)

⁸ $\alpha_i = 1, \dots, 7$ are gauge indices. $i, j, k, l \dots = 1, 2$ are $SU(2)_A$ flavor indices. $I, J, \dots = 1, \dots, 6$ are $SU(6)_{\tilde{Q}}$ flavor indices.

We then confine the SU gauge node with (2.87). The fields $l_{-\frac{7}{2}}$ and $l_{+\frac{7}{2}}$ get a mass. After integrating them out, computing $\det(\text{mesons})$ of degree 8, we get

\mathcal{T}_2 :

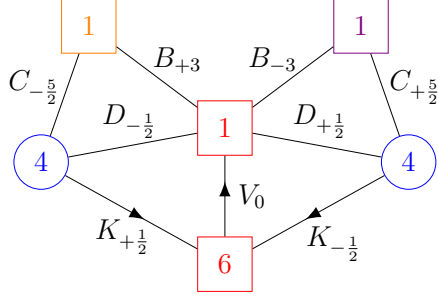

$$\mathcal{W} = \varepsilon_4 \varepsilon_4 \varepsilon^6 \left(K_{+\frac{1}{2}}^3 K_{-\frac{1}{2}}^3 C_{-\frac{5}{2}} C_{+\frac{5}{2}} \right)$$

- 4 Planar Triangles

(3.48)

Notice that B_{+3} , B_{-3} and V_0 are gauge singlets but are zero in the chiral ring, this is a quantum effect that can be seen dualizing the Usp nodes.

We can now S-confine the left $Usp(4)$ with (2.88). After integrating out massive fields, computing the Pfaffian superpotential we get

\mathcal{T}_3 :

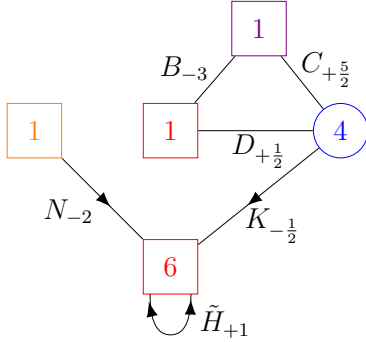

$$\mathcal{W} = \varepsilon_4 \varepsilon^6 \left(\tilde{H}_{+1} N_{-2} K_{-\frac{1}{2}}^3 C_{+\frac{5}{2}} \right)$$

$$- \varepsilon^6 \left(\tilde{H}_{+1}^2 N_{-2} K_{-\frac{1}{2}} D_{+\frac{1}{2}} \right) - B_{-3} D_{+\frac{1}{2}} C_{+\frac{5}{2}}$$

(3.49)

Finally, we repeat the same operation with the last gauge group and get the WZ model with quartic superpotential

\mathcal{T}_4 :

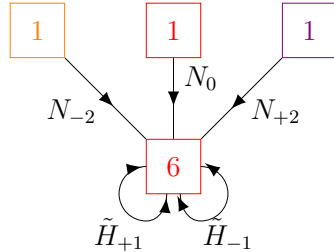

$$\mathcal{W} = \varepsilon^6 \left(\tilde{H}_{+1} \tilde{H}_{-1} N_{+2} N_{-2} \right)$$

$$- \tilde{H}_{+1}^2 N_0 N_{-2} + \tilde{H}_{-1}^2 N_{+2} N_0$$

(3.50)

The final superpotential can be repackaged in a manifest $SU(2)_A$ invariant way as

$$\mathcal{W} = \tilde{H}^2 N^2, \quad (3.51)$$

where $A\tilde{Q}^2 \leftrightarrow \tilde{H} = \{\tilde{H}_{+1}, \tilde{H}_{-1}\}$ is a $SU(2)_A$ doublet and $A^4\tilde{Q} \leftrightarrow N = \{N_{+2}, N_0, N_{-2}\}$ is a 2-symmetric tensor of $SU(2)_A$ (also called the triplet). We recover the result of Section 3.1.10

of [46]. The mapping of the chiral ring generators is

$$\begin{array}{ccccc}
\mathcal{T}_1 & & \mathcal{T}_1' & & \mathcal{T}_2 & & \mathcal{T}_3 & & \mathcal{T}_4 \\
A_{+1} \tilde{Q}^2 & & b_{+\frac{1}{2}} b_{+\frac{1}{2}} \tilde{Q}^2 & & K_{+\frac{1}{2}} K_{+\frac{1}{2}} & & \tilde{H}_{+1} & & \tilde{H}_{+1} \\
A_{-1} \tilde{Q}^2 & & b_{-\frac{1}{2}} b_{-\frac{1}{2}} \tilde{Q}^2 & & K_{-\frac{1}{2}} K_{-\frac{1}{2}} & & K_{-\frac{1}{2}} K_{-\frac{1}{2}} & & \tilde{H}_{-1} \\
\varepsilon_7 (A_{+1} A_{+1} A_{[+1} A_{-1]} \tilde{Q}) & \Leftrightarrow & b_{-\frac{1}{2}} \tilde{c}_{+3} b_{-\frac{1}{2}} \tilde{Q} & \Leftrightarrow & C_{+\frac{5}{2}} K_{-\frac{1}{2}} & & C_{+\frac{5}{2}} K_{-\frac{1}{2}} & \Leftrightarrow & N_{+2} \\
\varepsilon_7 (A_{(+1} A_{-1}) A_{[+1} A_{-1]} \tilde{Q}) & & \varepsilon_7 (b_{+\frac{1}{2}}^3 b_{-\frac{1}{2}}^3 b_{[+\frac{1}{2}} b_{-\frac{1}{2}]} \tilde{Q}) & & D_{-\frac{1}{2}} K_{+\frac{1}{2}} = D_{+\frac{1}{2}} K_{-\frac{1}{2}} & & D_{+\frac{1}{2}} K_{-\frac{1}{2}} & & N_0 \\
\varepsilon_7 (A_{-1} A_{-1} A_{[+1} A_{-1]} \tilde{Q}) & & b_{+\frac{1}{2}} \tilde{c}_{-3} b_{+\frac{1}{2}} \tilde{Q} & & C_{-\frac{5}{2}} K_{+\frac{1}{2}} & & N_{-2} & & N_{-2} \\
& & & & & & & & (3.52)
\end{array}$$

$$SU(6) \text{ with } \mathbf{2} \begin{array}{|c|} \hline \square \\ \hline \end{array} + \mathbf{5} \begin{array}{|c|} \hline \square \\ \hline \end{array} + \mathbf{1} \begin{array}{|c|} \hline \square \\ \hline \end{array}$$

The second sporadic case is the $SU(6)$ gauge theory with two antisymmetric fields, 5 antifundamentals and 1 fundamental, with continuous global symmetry $SU(2)_A \times SU(5)_{\tilde{Q}} \times U(1)^2$.

\mathcal{T}_1 :

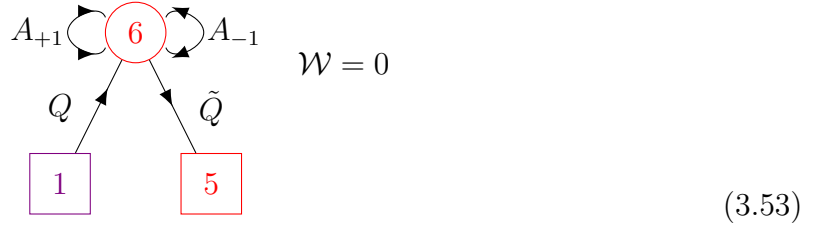

The chiral ring generators are

- $Q \tilde{Q} \sim Q^\alpha \tilde{Q}_\alpha^I$ transforming in the $(1, \square)$ of $SU(2)_A \times SU(5)_{\tilde{Q}}$
- $A \tilde{Q}^2 \sim A_i^{\alpha_1 \alpha_2} \tilde{Q}_{\alpha_1}^I \tilde{Q}_{\alpha_2}^J \sim (\square, \begin{array}{|c|} \hline \square \\ \hline \end{array})$
- $\varepsilon_6 A^3 \sim \varepsilon_{\alpha_1 \dots \alpha_6} A_{(i}^{\alpha_1 \alpha_2} A_j^{\alpha_3 \alpha_4} A_k^{\alpha_5 \alpha_6} \sim (\begin{array}{|c|c|c|} \hline \square & \square & \square \\ \hline \end{array}, 1)$
- $\varepsilon_6 A^3 Q \tilde{Q} \sim \varepsilon_{\alpha_1 \dots \alpha_6} \varepsilon^{i_2 i_3} A_{i_1}^{\alpha_1 \alpha_2} A_{i_2}^{\alpha_3 \alpha_4} A_{i_3}^{\alpha_5 \beta} Q^\alpha \tilde{Q}_\beta^I \sim (\square, \square)$
- $\varepsilon_6 (A^4 \tilde{Q}^2) \sim \varepsilon_{\alpha_1 \dots \alpha_6} \varepsilon^{ik} \varepsilon^{jl} A_i^{\alpha_1 \alpha_2} A_j^{\alpha_3 \alpha_4} A_k^{\alpha_5 \beta_1} A_l^{\alpha_6 \beta_2} \tilde{Q}_{\beta_1}^I \tilde{Q}_{\beta_2}^J \sim (1, \begin{array}{|c|} \hline \square \\ \hline \end{array})$

We will deconfine A_1 , using (2.103) and then our result in Section 3.2.3. This step breaks the $SU(2)_A$ symmetry into $U(1)_A$. In (3.53), the subscript of the two antisymmetric fields, $A_{\pm 1}$ correspond to the $U(1)_A$ charge. So let us give the chiral ring in this split form

- $A_{+1} \tilde{Q}^2 \sim A_{+1}^{\alpha_1 \alpha_2} \tilde{Q}_{\alpha_1}^I \tilde{Q}_{\alpha_2}^J \sim \begin{array}{|c|} \hline \square \\ \hline \end{array}$ of $SU(5)_{\tilde{Q}}$
- $A_{-1} \tilde{Q}^2 \sim A_{-1}^{\alpha_1 \alpha_2} \tilde{Q}_{\alpha_1}^I \tilde{Q}_{\alpha_2}^J \sim \begin{array}{|c|} \hline \square \\ \hline \end{array}$
- $\varepsilon_6 A_{+1}^3 \equiv \varepsilon_6 (A^3)_{111} \sim \varepsilon_{\alpha_1 \dots \alpha_6} A_{+1}^{\alpha_1 \alpha_2} A_{+1}^{\alpha_3 \alpha_4} A_{+1}^{\alpha_5 \alpha_6} \sim 1$
- $\varepsilon_6 (A_{+1}^2 A_{-1}) \equiv \varepsilon_6 (A^3)_{112} \sim \varepsilon_{\alpha_1 \dots \alpha_6} A_{+1}^{\alpha_1 \alpha_2} A_{+1}^{\alpha_3 \alpha_4} A_{-1}^{\alpha_5 \alpha_6} \sim 1$
- $\varepsilon_6 (A_{+1} A_{-1}^2) \equiv \varepsilon_6 (A^3)_{122} \sim \varepsilon_{\alpha_1 \dots \alpha_6} A_{+1}^{\alpha_1 \alpha_2} A_{-1}^{\alpha_3 \alpha_4} A_{-1}^{\alpha_5 \alpha_6} \sim 1$
- $\varepsilon_6 A_{-1}^3 \equiv \varepsilon_6 (A^3)_{222} \sim \varepsilon_{\alpha_1 \dots \alpha_6} A_{-1}^{\alpha_1 \alpha_2} A_{-1}^{\alpha_3 \alpha_4} A_{-1}^{\alpha_5 \alpha_6} \sim 1$

- $\varepsilon_6 (A_{+1}A_{[+1}A_{-1]}Q\tilde{Q}) \sim \varepsilon_{\alpha_1\dots\alpha_6} A_{+1}^{\alpha_1\alpha_2} \left(A_{+1}^{\alpha_3\alpha_4} A_{-1}^{\alpha_5\beta} - A_{-1}^{\alpha_3\alpha_4} A_{+1}^{\alpha_5\beta} \right) Q^{\alpha_6} \tilde{Q}_\beta^I \sim \square$
- $\varepsilon_6 (A_{-1}A_{[+1}A_{-1]}Q\tilde{Q}) \sim \varepsilon_{\alpha_1\dots\alpha_6} A_{-1}^{\alpha_1\alpha_2} \left(A_{+1}^{\alpha_3\alpha_4} A_{-1}^{\alpha_5\beta} - A_{-1}^{\alpha_3\alpha_4} A_{+1}^{\alpha_5\beta} \right) Q^{\alpha_6} \tilde{Q}_\beta^I \sim \square$
- $\varepsilon_6 (A_{[+1}A_{-1]}A_{[+1}A_{-1]}\tilde{Q}^2) \sim \varepsilon_{\alpha_1\dots\alpha_6} \left(A_{[+1}^{\alpha_1\alpha_2} A_{-1}^{\alpha_5\beta_1} \right) \left(A_{[+1}^{\alpha_3\alpha_4} A_{-1}^{\alpha_6\beta_2} \right) \tilde{Q}_{\beta_1}^I \tilde{Q}_{\beta_2}^J \sim 1$

\mathcal{T}_1 :

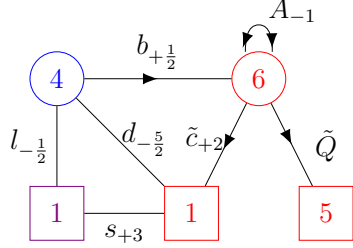

$$\mathcal{W} = \text{Plannar Triangle} - l_{-\frac{1}{2}} d_{-\frac{5}{2}} s_{+3}$$

(3.54)

Now we want to use the result of the section (3.2.3), specialized in the case $N=3$. Before using the superpotential (3.44), we should split the 6 antifundamentals into $5+1$. More precisely, \tilde{H} , the antisymmetric of the global $SU(6)_{\tilde{Q}}$ there, split into \tilde{H}_{-1} , an antisymmetric of $SU(5)_{\tilde{Q}}$ and D_{+1} a fundamental. Similarly, M , the fundamental of $SU(6)$ there, split into a fundamental, $N_{+\frac{1}{2}}$ and a singlet (under the global $SU(5)_{\tilde{Q}}$ symmetry) $(b\tilde{c})_{+\frac{5}{2}}$. We should also split B_2 , the antisymmetric of $SU(4)_Q$ into a traceless antisymmetric tensor of $Usp(4)$ B_{-1} and a singlet s_{-1} . Finally, we rename the three singlets B_4, B_0 and \tilde{B} there as s_{+1}, s_{-3} and β_{+2} . After this splitting, the use of (3.44) give

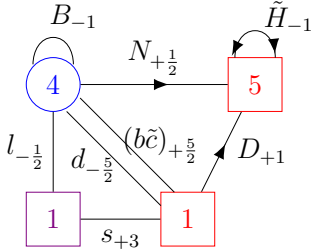

+ singlets (s_{+1}, s_{-1}, s_{-3} & β_{+2})

$$\begin{aligned} \mathcal{W} = & \varepsilon_5 \left(\tilde{H}_{-1}^2 D_{+1} s_{+1} + N_{+\frac{1}{2}}^2 \tilde{H}_{-1} D_{+1} s_{-1} + B_{-1} N_{+\frac{1}{2}}^2 \tilde{H}_{-1} D_{+1} \right. \\ & + N_{+\frac{1}{2}} (b\tilde{c})_{+\frac{5}{2}} \tilde{H}_{-1}^2 s_{-1} + B_{-1} N_{+\frac{1}{2}} (b\tilde{c})_{+\frac{5}{2}} \tilde{H}_{-1}^2 - N_{+\frac{1}{2}}^4 D_{+1} s_{-3} \\ & \left. - N_{+\frac{1}{2}}^3 (b\tilde{c})_{+\frac{5}{2}} \tilde{H}_{-1} s_{-3} \right) - s_{+1} s_{-3} \beta_{+2} - \beta_{+2} s_{-1}^2 - \beta_{+2} B_{-1}^2 \\ & - l_{-\frac{1}{2}} d_{-\frac{5}{2}} s_{+3} + d_{-\frac{5}{2}} (b\tilde{c})_{+\frac{5}{2}} \end{aligned}$$

(3.55)

After integrating out the massive fields $d_{-\frac{5}{2}}, (b\tilde{c})_{+\frac{5}{2}}$, we obtain

\mathcal{T}_2 :

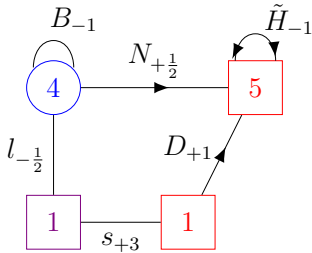

+ singlets (s_{+1}, s_{-1}, s_{-3} & β_{+2})

$$\begin{aligned} \mathcal{W} = & \varepsilon_5 \left(\tilde{H}_{-1}^2 D_{+1} s_{+1} + N_{+\frac{1}{2}}^2 \tilde{H}_{-1} D_{+1} s_{-1} + B_{-1} N_{+\frac{1}{2}}^2 \tilde{H}_{-1} D_{+1} \right. \\ & + N_{+\frac{1}{2}} l_{-\frac{1}{2}} \tilde{H}_{-1}^2 s_{+3} s_{-1} + B_{-1} N_{+\frac{1}{2}} l_{-\frac{1}{2}} \tilde{H}_{-1}^2 s_{+3} - N_{+\frac{1}{2}}^4 D_{+1} s_{-3} \\ & \left. - N_{+\frac{1}{2}}^3 l_{-\frac{1}{2}} \tilde{H}_{-1} s_{+3} s_{-3} \right) - s_{+1} s_{-3} \beta_{+2} - \beta_{+2} s_{-1}^2 - \beta_{+2} B_{-1}^2 \end{aligned}$$

(3.56)

Now we want to confine the $Usp(4)$ gauge group with the antisymmetric and 6 flavors. Unfortunately, we cannot immediately use our result about $Usp(2N)$ of Section 3.2.1 for the following

reason. The flipper β_{+2} appears in (3.56) in three different terms but we know the final superpotential only when we flip the whole tower of the traces of the antisymmetric as in (3.2). In this case since the rank is small, it is easy to apply our strategy of the Section 3.2.1 starting with $\mathcal{W} = 0$ to get

$$\mathcal{W} = 0 \quad \equiv \quad \mathcal{W} = \varepsilon_5 \left(T_{-2} \tilde{H}_{+1}^2 M_0 + \Phi_0 \tilde{H}_{+1} D_{-1} + M_0 \Phi_0^2 \right) \quad (3.57)$$

The mapping is $N_{+\frac{1}{2}} N_{+\frac{1}{2}} \longleftrightarrow \tilde{H}_1, N_{+\frac{1}{2}} l_{-\frac{1}{2}} \longleftrightarrow M_0, N_{+\frac{1}{2}}^2 B_{-1} \longleftrightarrow \Phi_0, N_{+\frac{1}{2}} l_{-\frac{1}{2}} B_{-1} \longleftrightarrow D_{-1}$ and $B_{-1}^2 \longleftrightarrow T_{-2}$.

We now use this result into (3.56). We see that the singlets β_{+2} and T_{-2} become massive. After integrating them out and rescaling fields, we get the final result

$\mathcal{T}_3 :$

$$\mathcal{W} = \varepsilon_5 \left(\tilde{H}_{-1}^2 D_{+1} s_{+1} + \tilde{H}_{+1} \tilde{H}_{-1} D_{+1} s_{-1} + \tilde{H}_{-1}^2 D_{-1} s_{+3} - \tilde{H}_{+1}^2 D_{+1} s_{-3} + \Phi_0 \tilde{H}_{-1} D_{+1} - \Phi_0 \tilde{H}_{+1} D_{-1} - M_0 \tilde{H}_{+1} \tilde{H}_{-1} s_{+3} s_{-3} + M_0 \tilde{H}_{-1}^2 s_{+3} s_{-1} - M_0 \tilde{H}_{+1}^2 s_{+1} s_{-3} - M_0 \tilde{H}_{+1}^2 s_{-1}^2 + M_0 \Phi_0^2 \right) + \text{singlets } (s_{+3}, s_{+1}, s_{-1} \& s_{-3}) \quad (3.58)$$

The final superpotential can be repackaged in a manifest $SU(2)_A$ invariant way as

$$\mathcal{W} = \tilde{H}^2 D S + \Phi_0 \tilde{H} D + M_0 \tilde{H}^2 S^2 + M_0 \Phi_0^2, \quad (3.59)$$

where $A^3 \leftrightarrow S = \{s_{+3}, s_{+1}, s_{-1}, s_{-3}\}$ is a completely symmetric 3-tensor of $SU(2)_A$, $A\tilde{Q}^2 \leftrightarrow \tilde{H} = \{\tilde{H}_{+1}, \tilde{H}_{-1}\}$, $A^3 Q\tilde{Q} \leftrightarrow D = \{D_{+1}, D_{-1}\}$ are $SU(2)_A$ doublets and $Q\tilde{Q} \leftrightarrow M_0$, $A^4 \tilde{Q}^2 \leftrightarrow \Phi_0$ are $SU(2)_A$ singlets. We recover the result of Section 3.1.9 of [46]. The final mapping of the

chiral ring generators is

$$\begin{array}{ccccccc}
\mathcal{T}_1 & & \mathcal{T}_{1'} & & \mathcal{T}_2 & & \mathcal{T}_3 \\
Q \tilde{Q} & & l_{-\frac{1}{2}} b_{+\frac{1}{2}} \tilde{Q} & & l_{-\frac{1}{2}} N_{+\frac{1}{2}} & & M_0 \\
A_{+1} \tilde{Q}^2 & & b_{+\frac{1}{2}} b_{+\frac{1}{2}} \tilde{Q}^2 & & N_{+\frac{1}{2}} N_{+\frac{1}{2}} & & \tilde{H}_1 \\
A_{-1} \tilde{Q}^2 & & A_{-1} \tilde{Q}^2 & & \tilde{H}_{-1} & & \tilde{H}_{-1} \\
\varepsilon_6 A_{+1}^3 & & s_{+3} & & s_{+3} & & s_{+3} \\
\varepsilon_6 (A_{+1}^2 A_{-1}) & \iff & \varepsilon_6 (b_{+\frac{1}{2}}^4 A_{-1}) & \iff & s_{+1} & \iff & s_{+1} \\
\varepsilon_6 (A_{-1}^2 A_{+1}) & & \varepsilon_6 (b_{+\frac{1}{2}}^2 A_{-1}^2) & & s_{-1} & & s_{-1} \\
\varepsilon_6 A_{-1}^3 & & \varepsilon_6 (A_{-1}^3) & & s_{-3} & & s_{-3} \\
\varepsilon_6 (A_{+1} A_{+1} A_{-1} Q \tilde{Q}) & & A_{-1} \tilde{c}_{+2} \tilde{Q} & & D_{+1} & & D_{+1} \\
\varepsilon_6 (A_{-1} A_{+1} A_{-1} Q \tilde{Q}) & & \varepsilon_6 (A_{-1}^2 b_{+\frac{1}{2}}^3 l_{-\frac{1}{2}} \tilde{Q}) & & N_{+\frac{1}{2}} l_{-\frac{1}{2}} B_{-1} & & D_{-1} \\
\varepsilon_6 (A_{+1} A_{-1} A_{+1} A_{-1} \tilde{Q}^2) & & \varepsilon_6 (b_{+\frac{1}{2}}^4 A_{-1}^2 \tilde{Q}^2) & & N_{+\frac{1}{2}}^2 B_{-1} & & \Phi_0
\end{array} \tag{3.60}$$

$SU(5)$ with $2 \begin{array}{|c|} \hline \square \\ \hline \end{array} + 4 \begin{array}{|c|} \hline \bar{\square} \\ \hline \end{array} + 2 \begin{array}{|c|} \hline \square \\ \hline \end{array}$

The third case is the $SU(5)$ gauge theory with 2 antisymmetric, 4 antifundamental and 2 fundamental fields with continuous global symmetry $SU(2)_A \times SU(4)_{\tilde{Q}} \times SU(2)_Q \times U(1)^2$.

$\mathcal{T}_1 :$

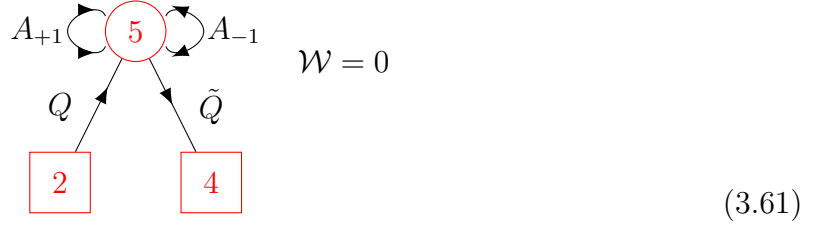

The chiral ring generators are

- $Q \tilde{Q} \sim Q_i^\alpha \tilde{Q}_\alpha^I$ transforming in the $(1, \square, \square)$ of $SU(2)_A \times SU(4)_{\tilde{Q}} \times SU(2)_Q$
- $A \tilde{Q}^2 \sim A_a^{\alpha_1 \alpha_2} \tilde{Q}_{\alpha_1}^I \tilde{Q}_{\alpha_2}^J \sim (\square, \begin{array}{|c|} \hline \square \\ \hline \end{array}, 1)$
- $\varepsilon_5 (A^2 Q) \sim \varepsilon_{\alpha_1 \dots \alpha_5} A_{(a}^{\alpha_1 \alpha_2} A_{b)}^{\alpha_3 \alpha_4} Q_i^{\alpha_5} \sim (\begin{array}{|c|} \hline \square \square \\ \hline \end{array}, 1, \square)$
- $\varepsilon_5 (A^3 \tilde{Q}) \sim \varepsilon_{\alpha_1 \dots \alpha_5} \varepsilon^{b_1 b_2} A_a^{\alpha_1 \alpha_2} A_{b_1}^{\alpha_3 \alpha_4} A_{b_2}^{\alpha_5 \beta} \tilde{Q}_\beta^I \sim (\square, \square, 1)$
- $\varepsilon_5 (A^2 Q^2 \tilde{Q}) \sim \varepsilon_{\alpha_1 \dots \alpha_5} \varepsilon^{b_1 b_2} \varepsilon^{i_1, i_2} A_{b_1}^{\alpha_1 \alpha_2} A_{b_2}^{\alpha_3 \beta} Q_{i_1}^{\alpha_4} Q_{i_2}^{\alpha_5} \tilde{Q}_\beta^I \sim (1, \square, 1)$

We now deconfine the two antisymmetric using (2.107) and so we break $SU(2)_A$ into $U(1)_A$. In (3.61), the subscript of the two antisymmetric fields, $A_{\pm 1}$ correspond to the $U(1)_A$ charge (corresponding to the weight of the representation of $SU(2)_A$). After the splitting, the chiral ring generators become

- $A_{+1} \tilde{Q}^2 \sim A_{+1}^{\alpha_1 \alpha_2} \tilde{Q}_{\alpha_1}^I \tilde{Q}_{\alpha_2}^J \sim (\begin{array}{|c|} \hline \square \\ \hline \end{array}, 1)$ of $SU(4)_{\tilde{Q}} \times SU(2)_Q$

- $A_{-1}\tilde{Q}^2 \sim A_{-1}^{\alpha_1\alpha_2} \tilde{Q}_{\alpha_1}^I \tilde{Q}_{\alpha_2}^J \sim (\square, 1)$
- $\varepsilon_5(A_{+1}^2 Q) \sim \varepsilon_{\alpha_1\dots\alpha_5} A_{+1}^{\alpha_1\alpha_2} A_{+1}^{\alpha_3\alpha_4} Q_i^{\alpha_5} \sim (1, \square)$
- $\varepsilon_5(A_{+1}A_{-1}Q) \sim \varepsilon_{\alpha_1\dots\alpha_5} A_{(+1)}^{\alpha_1\alpha_2} A_{(-1)}^{\alpha_3\alpha_4} Q_i^{\alpha_5} \sim (1, \square)$
- $\varepsilon_5(A_{-1}^2 Q) \sim \varepsilon_{\alpha_1\dots\alpha_5} A_{-1}^{\alpha_1\alpha_2} A_{-1}^{\alpha_3\alpha_4} Q_i^{\alpha_5} \sim (1, \square)$
- $\varepsilon_5(A_{+1}A_{+1}A_{-1}\tilde{Q}) \sim \varepsilon_{\alpha_1\dots\alpha_5} A_{+1}^{\alpha_1\alpha_2} A_{+1}^{\alpha_3\alpha_4} A_{-1}^{\alpha_5\beta} \tilde{Q}_\beta^I \sim (\square, 1)$
- $\varepsilon_5(A_{-1}A_{+1}A_{-1}\tilde{Q}) \sim \varepsilon_{\alpha_1\dots\alpha_5} A_{-1}^{\alpha_1\alpha_2} A_{+1}^{\alpha_3\alpha_4} A_{-1}^{\alpha_5\beta} \tilde{Q}_\beta^I \sim (\square, 1)$
- $\varepsilon_5(A_{+1}A_{-1}Q^2\tilde{Q}) \sim \varepsilon_{\alpha_1\dots\alpha_5} \varepsilon^{i_1,i_2} A_{+1}^{\alpha_1\alpha_2} A_{-1}^{\alpha_3\beta} Q_{i_1}^{\alpha_4} Q_{i_2}^{\alpha_5} \tilde{Q}_\beta^I \sim (\square, 1)$

\mathcal{T}_1' :

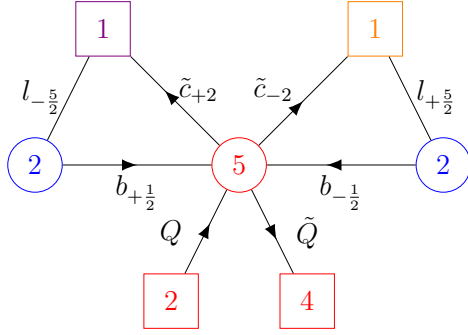

$\mathcal{W} = -2$ Planar Triangles

(3.62)

Once again, the subscripts in (3.62) correspond to the $U(1)_A$ charges of the fields. The next step is to confine the $SU(5)$ gauge group with (2.87). Notice that $l_{-\frac{5}{2}}$ and $l_{+\frac{5}{2}}$ will become massive. After integrating them out, computing the $\det(\text{mesons})$ of degree 6, we obtain

\mathcal{T}_2 :

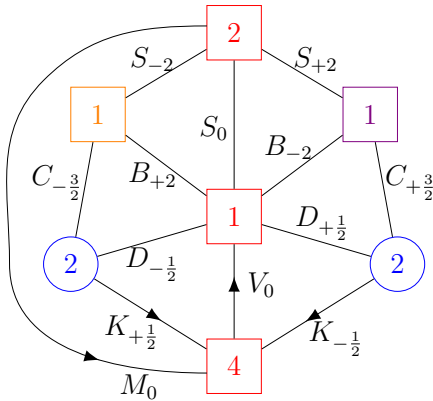

$$\begin{aligned} \mathcal{W} = & \varepsilon_4 \varepsilon^2 \varepsilon^2 \varepsilon^2 \left[M_0^2 C_{-\frac{3}{2}} K_{+\frac{1}{2}} C_{+\frac{3}{2}} K_{-\frac{1}{2}} \right. \\ & - K_{+\frac{1}{2}}^2 K_{-\frac{1}{2}}^2 S_{-2} S_{+2} - K_{+\frac{1}{2}}^2 C_{+\frac{3}{2}} K_{-\frac{1}{2}} S_{-2} M_0 \\ & \left. + K_{-\frac{1}{2}}^2 C_{-\frac{3}{2}} K_{+\frac{1}{2}} S_{+2} M_0 \right] - S_0 V_0 M_0 \\ & - 6 \text{ Planar Triangles} \end{aligned}$$

(3.63)

Then we use (2.88) for the left $Usp(2)$. The fields B_{+2} and V_0 get a mass. We have to integrate them out and compute the Pfaffian superpotential. Let us write more explicitly the Pfaffian term because it will be useful later. The mesons involving in the Pfaffian are $n_{-1} \equiv [C_{-\frac{3}{2}} K_{+\frac{1}{2}}]$, $\tilde{H}_{+1} \equiv [K_{+\frac{1}{2}} K_{+\frac{1}{2}}]$, $[D_{-\frac{1}{2}} K_{+\frac{1}{2}}]$ and $[C_{-\frac{3}{2}} D_{-\frac{1}{2}}]$. We didn't give a name to the last two mesons because they are massive and will be integrate out by the E.O.M of V_0 and

B_{+2} . The Pfaffian is then given by

$$\text{Pfaff} \begin{pmatrix} \tilde{H}_{+1} & [D_{-\frac{1}{2}}K_{+\frac{1}{2}}] & n_{-1} \\ & 0 & [C_{-\frac{3}{2}}D_{-\frac{1}{2}}] \\ & & 0 \end{pmatrix} \sim \varepsilon_4 \left[\tilde{H}_{+1}^2 [C_{-\frac{3}{2}}D_{-\frac{1}{2}}] + \tilde{H}_{+1}n_{-1} [D_{-\frac{1}{2}}K_{+\frac{1}{2}}] \right] \quad (3.64)$$

$$\begin{aligned} \text{E.O.M: from } V_0 : [D_{-\frac{1}{2}}K_{+\frac{1}{2}}] &= -K_{-\frac{1}{2}}D_{+\frac{1}{2}} - S_0M_0 \\ \text{from } B_{+2} : [C_{-\frac{3}{2}}D_{-\frac{1}{2}}] &= -S_{-2}S_0 \end{aligned}$$

Where we rescaled the fields. Therefore the Pfaffian gives the following contribution

$$\text{Pfaff} () = \varepsilon_4 \left[-\tilde{H}_{+1}^2 S_{-2}S_0 - \tilde{H}_{+1}n_{-1} \left(K_{-\frac{1}{2}}D_{+\frac{1}{2}} + S_0M_0 \right) \right] \quad (3.65)$$

The theory after this $Usp(2)_{left}$ confinement is

\mathcal{T}_3 :

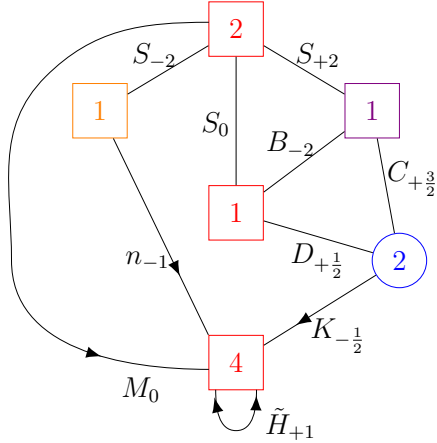

$$\begin{aligned} \mathcal{W} = & \varepsilon_4 \varepsilon^2 \varepsilon^2 \left[M_0^2 n_{-1} C_{+\frac{3}{2}} K_{-\frac{1}{2}} \right. \\ & - \tilde{H}_{+1} K_{-\frac{1}{2}}^2 S_{+2} S_{-2} - \tilde{H}_{+1} C_{+\frac{3}{2}} K_{-\frac{1}{2}} S_{-2} M_0 \\ & \left. + K_{-\frac{1}{2}}^2 n_{-1} S_{+2} M_0 \right] - \varepsilon_4 \left[\tilde{H}_{+1}^2 S_{-2} S_0 \right. \\ & \left. + \tilde{H}_{+1} n_{-1} \left(K_{-\frac{1}{2}} D_{+\frac{1}{2}} + S_0 M_0 \right) \right] \\ & - S_0 B_{-2} S_{+2} - B_{-2} D_{+\frac{1}{2}} C_{+\frac{3}{2}} \end{aligned} \quad (3.66)$$

The last step is to confine the other $Usp(2)$. The field B_{-2} gets a mass. As in the last step, let us write the Pfaffian term. The mesons involve are: $\tilde{H}_{-1} \equiv [K_{-\frac{1}{2}}K_{-\frac{1}{2}}]$, $f_0 \equiv [K_{-\frac{1}{2}}D_{+\frac{1}{2}}]$, $n_{+1} \equiv [C_{+\frac{3}{2}}K_{-\frac{1}{2}}]$ and $[C_{+\frac{3}{2}}D_{+\frac{1}{2}}]$. The last one is massive and will be integrate out with the E.O.M of B_{-2} . The Pfaffian is

$$\text{Pfaff} \begin{pmatrix} \tilde{H}_{-1} & f_0 & n_{+1} \\ & 0 & [C_{+\frac{3}{2}}D_{+\frac{1}{2}}] \\ & & 0 \end{pmatrix} \sim \varepsilon_4 \left[\tilde{H}_{-1}^2 [C_{+\frac{3}{2}}D_{+\frac{1}{2}}] + \tilde{H}_{-1}n_{+1}f_0 \right] \quad (3.67)$$

$$\text{E.O.M: from } B_{-2} : [C_{+\frac{3}{2}}D_{+\frac{1}{2}}] = -S_{+2}S_0$$

Where we rescaled the fields. Therefore the Pfaffian gives the following contribution

$$\text{Pfaff} () = \varepsilon_4 \left[-\tilde{H}_{-1}^2 S_{+2}S_0 + \tilde{H}_{-1}n_{+1}f_0 \right] \quad (3.68)$$

We get the following WZ model

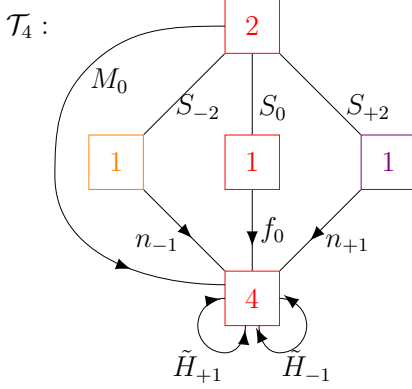

$$\begin{aligned}
\mathcal{W} = \varepsilon_4 & (M_0^2 n_{-1} n_{+1} - \tilde{H}_{+1} \tilde{H}_{-1} S_{+2} S_{-2} \\
& - \tilde{H}_{+1}^2 S_{-2} S_0 - \tilde{H}_{-1}^2 S_{+2} S_0 - \tilde{H}_{+1} n_{+1} S_{-2} M_0 \\
& + \tilde{H}_{-1} n_{-1} S_{+2} M_0 - \tilde{H}_{+1} n_{-1} (f_0 + S_0 M_0) \\
& + \tilde{H}_{-1} n_{+1} f_0 + \tilde{H}_{-1} n_{+1} S_0 M_0)
\end{aligned} \tag{3.69}$$

The final superpotential can be repackaged in a manifest $SU(2)_A$ invariant way as

$$\mathcal{W} = M_0^2 N^2 + \tilde{H}^2 S^2 + \tilde{H} N f_0 + \tilde{H} N S M_0, \tag{3.70}$$

where $A^2 Q \leftrightarrow S = \{S_{+2}, S_{-2}, S_0\}$ is a symmetric 2-tensor of $SU(2)_A$, $A^3 \tilde{Q} \leftrightarrow N = \{n_{+1}, n_{-1}\}$, $A \tilde{Q}^2 \leftrightarrow \tilde{H} = \{\tilde{H}_{+1}, \tilde{H}_{-1}\}$ are $SU(2)_A$ doublets and $Q \tilde{Q} \leftrightarrow M_0$, $A^2 Q^2 \tilde{Q} \leftrightarrow f_0$ are $SU(2)_A$ singlets. We recover the result of Section 3.1.8 of [46].

Before moving on, we should comment on the red term in (3.69): $\tilde{H}_{-1} n_{+1} S_0 M_0$. Indeed, if we combine the superpotential in (3.66) with the Pfaffian term (3.68) we get the superpotential in (3.69) *without* this red term. So why did we add it and where does it come from? First, we remark that without this term it would not be possible to repackage the superpotential in a manifestly $SU(2)_A$ invariant way as in (3.70). In addition, this term is invariant under all the global symmetries including the $U(1)^2 \times U(1)_A$. There is another argument that suggest the presence of this term. Suppose that after the frame \mathcal{T}_2 , we decide to confine in the reverse order meaning that we first confine the $Usp(2)_{right}$ and then the $Usp(2)_{left}$. With this order, the term $\tilde{H}_{-1} n_{+1} S_0 M_0$ is present in the frame \mathcal{T}_4 and it would be the term $\tilde{H}_{+1} n_{-1} S_0 M_0$ missing. The last observation is that it would have been possible to add an extra term that respect all the global symmetries in all the previous frame (\mathcal{T}_1 to \mathcal{T}_3) and which lead to the red term in \mathcal{T}_4 . However, we believe that this extra term is forbidden in the frames $\mathcal{T}_1, \mathcal{T}_2, \mathcal{T}_3$ because of chiral ring stability. Therefore, chiral ring stability will force us to wait up to the last frame before adding this extra term allowed by the global symmetries.

This subtle point seems to come from the fact that we have degenerate holomorphic operators in \mathcal{T}_2 : $[D_{-\frac{1}{2}} K_{+\frac{1}{2}}], [K_{-\frac{1}{2}} D_{+\frac{1}{2}}]$ and $S_0 M_0$. It suggests that in presence of degenerate operators, applying a duality locally (to a particular node inside a quiver) would miss some informations. We will see another instance of this phenomenon in the next section.

One prescription that lead to the correct final superpotential is the following: When going from \mathcal{T}_3 to \mathcal{T}_4 , during the computation of the Pfaffian superpotential (3.68), we should not use f_0 but the combination $f_0 + S_0 M_0$. One can understand this prescription in the following way: In the frames \mathcal{T}_1 to \mathcal{T}_2 there is a \mathbb{Z}_2 symmetry, corresponding to the Weyl reflection inside $SU(2)_A$, which maps a field with $U(1)_A$ charge x to the field with charge $-x$. When we go to the frame \mathcal{T}_3 , this symmetry is not explicit anymore. Imposing the restoration of this symmetry in \mathcal{T}_4 is enough to give the correct superpotential. This is the role of this prescription.

The mapping of the chiral ring generators is

$$\begin{array}{cccccc}
\mathcal{T}_1 & & \mathcal{T}_1' & & \mathcal{T}_2 & & \mathcal{T}_3 & & \mathcal{T}_4 \\
Q \tilde{Q} & & Q \tilde{Q} & & M_0 & & M_0 & & M_0 \\
A_{+1} \tilde{Q}^2 & & b_{+\frac{1}{2}} b_{+\frac{1}{2}} \tilde{Q}^2 & & K_{+\frac{1}{2}}^2 & & \tilde{H}_{+1} & & \tilde{H}_{+1} \\
A_{-1} \tilde{Q}^2 & & b_{-\frac{1}{2}} b_{-\frac{1}{2}} \tilde{Q}^2 & & K_{-\frac{1}{2}}^2 & & K_{-\frac{1}{2}}^2 & & \tilde{H}_{-1} \\
\varepsilon_5 (A_{+1}^2 Q) & \Leftrightarrow & \tilde{c}_{+2} Q & \Leftrightarrow & S_{+2} & \Leftrightarrow & S_{+2} & \Leftrightarrow & S_{+2} \\
\varepsilon_5 (A_{-1}^2 Q) & & \tilde{c}_{-2} Q & & S_{-2} & & S_{-2} & & S_{-2} \\
\varepsilon_5 (A_{+1} A_{-1} Q) & & \varepsilon_5 (b_{+\frac{1}{2}} b_{+\frac{1}{2}} b_{-\frac{1}{2}} b_{-\frac{1}{2}} Q) & & S_0 & & S_0 & & S_0 \\
\varepsilon_5 (A_{-1} A_{[+1} A_{-1]} \tilde{Q}) & & b_{+\frac{1}{2}} \tilde{c}_{-2} b_{+\frac{1}{2}} \tilde{Q} & & C_{-\frac{3}{2}} K_{+\frac{1}{2}} & & n_{-1} & & n_{-1} \\
\varepsilon_5 (A_{+1} A_{[+1} A_{-1]} \tilde{Q}) & & b_{-\frac{1}{2}} \tilde{c}_{+2} b_{-\frac{1}{2}} \tilde{Q} & & C_{+\frac{3}{2}} K_{-\frac{1}{2}} & & C_{+\frac{3}{2}} K_{-\frac{1}{2}} & & n_{+1} \\
\varepsilon_5 (A_{[+1} A_{-1]} Q^2 \tilde{Q}) & & \varepsilon_5 (b_{+\frac{1}{2}} b_{-\frac{1}{2}} b_{[+\frac{1}{2}} b_{-\frac{1}{2}}] Q^2 \tilde{Q}) & & D_{+\frac{1}{2}} K_{-\frac{1}{2}} & & D_{+\frac{1}{2}} K_{-\frac{1}{2}} & & f_0
\end{array} \quad (3.71)$$

We stress that the last line in the mapping (3.71) is ambiguous in the intermediate frames. Indeed, in the frames \mathcal{T}_2 and \mathcal{T}_3 there are multiple holomorphic operators with the same quantum numbers under all the global symmetries which should map to a single chiral ring generator.

$SU(5)$ with $3 \begin{array}{|c|} \hline \square \\ \hline \end{array} + 3 \begin{array}{|c|} \hline \bar{\square} \\ \hline \end{array}$

Our last case is the $SU(5)$ gauge theory with 3 antisymmetric and 3 antifundamental fields with continuous global symmetry $SU(3)_A \times SU(3)_{\tilde{Q}} \times U(1)$.

\mathcal{T}_1 :

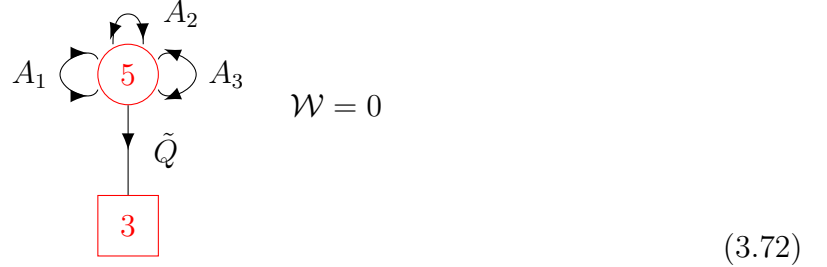

The chiral ring generators are

- $A \tilde{Q}^2 \sim A_a^{\alpha_1 \alpha_2} \tilde{Q}_{\alpha_1}^I \tilde{Q}_{\alpha_2}^J$ transforming in the (\square, \square) of $SU(3)_A \times SU(3)_{\tilde{Q}}$
- $\varepsilon_5 \varepsilon_5 A^5 \sim \varepsilon_{\alpha_1 \dots \alpha_5} \varepsilon_{\beta_1 \dots \beta_5} \varepsilon^{b_1 b_2 b_3} A_{(a_1}^{\alpha_1 \beta_1} A_{a_2)}^{\alpha_2 \beta_2} A_{b_1}^{\alpha_3 \beta_3} A_{b_2}^{\alpha_4 \beta_4} A_{b_3}^{\alpha_5 \beta_5} \sim (\square \square, 1)$
- $\varepsilon_5 (A^3 \tilde{Q}) \sim \varepsilon_{\alpha_1 \dots \alpha_5} \varepsilon^{c b_1 b_2} A_a^{\alpha_1 \alpha_2} A_{b_1}^{\alpha_3 \alpha_4} A_{b_2}^{\alpha_5 \beta} \tilde{Q}_\beta^I \sim (\square \square, \square)$

Now we deconfine the three antisymmetric, breaking $SU(3)_A$ to $U(1)_A^2$. Contrary to the others “sporadic” cases, the subscripts here do not correspond to the $U(1)_A$ charges. After the splitting the chiral ring generators are given by

- $A_1 \tilde{Q}^2 \sim A_1^{\alpha_1 \alpha_2} \tilde{Q}_{\alpha_1}^I \tilde{Q}_{\alpha_2}^J$ transforming in the \square of $SU(3)_{\tilde{Q}}$
- $A_2 \tilde{Q}^2 \sim A_2^{\alpha_1 \alpha_2} \tilde{Q}_{\alpha_1}^I \tilde{Q}_{\alpha_2}^J \sim \square$
- $A_3 \tilde{Q}^2 \sim A_3^{\alpha_1 \alpha_2} \tilde{Q}_{\alpha_1}^I \tilde{Q}_{\alpha_2}^J \sim \square$

- $\varepsilon_5 \varepsilon_5 (A_1 A_1 A_{[1} A_2 A_3]) \equiv (A^5)_{11} \sim \varepsilon_{\alpha_1 \dots \alpha_5} \varepsilon_{\beta_1 \dots \beta_5} A_1^{\alpha_1 \beta_1} A_1^{\alpha_2 \beta_2} A_{[1}^{\alpha_3 \beta_3} A_2^{\alpha_4 \beta_4} A_3^{\alpha_5 \beta_5} \sim 1$
- $\varepsilon_5 \varepsilon_5 (A_{(1} A_2) A_{[1} A_2 A_3]) \equiv (A^5)_{12} \sim \varepsilon_{\alpha_1 \dots \alpha_5} \varepsilon_{\beta_1 \dots \beta_5} A_{(1}^{\alpha_1 \beta_1} A_2^{\alpha_2 \beta_2} A_{[1}^{\alpha_3 \beta_3} A_2^{\alpha_4 \beta_4} A_3^{\alpha_5 \beta_5} \sim 1$
- $\varepsilon_5 \varepsilon_5 (A_{(1} A_3) A_{[1} A_2 A_3]) \equiv (A^5)_{13} \sim \varepsilon_{\alpha_1 \dots \alpha_5} \varepsilon_{\beta_1 \dots \beta_5} A_{(1}^{\alpha_1 \beta_1} A_3^{\alpha_2 \beta_2} A_{[1}^{\alpha_3 \beta_3} A_2^{\alpha_4 \beta_4} A_3^{\alpha_5 \beta_5} \sim 1$
- $\varepsilon_5 \varepsilon_5 (A_2 A_2 A_{[1} A_2 A_3]) \equiv (A^5)_{22} \sim \varepsilon_{\alpha_1 \dots \alpha_5} \varepsilon_{\beta_1 \dots \beta_5} A_2^{\alpha_1 \beta_1} A_2^{\alpha_2 \beta_2} A_{[1}^{\alpha_3 \beta_3} A_2^{\alpha_4 \beta_4} A_3^{\alpha_5 \beta_5} \sim 1$
- $\varepsilon_5 \varepsilon_5 (A_{(2} A_3) A_{[1} A_2 A_3]) \equiv (A^5)_{23} \sim \varepsilon_{\alpha_1 \dots \alpha_5} \varepsilon_{\beta_1 \dots \beta_5} A_{(2}^{\alpha_1 \beta_1} A_3^{\alpha_2 \beta_2} A_{[1}^{\alpha_3 \beta_3} A_2^{\alpha_4 \beta_4} A_3^{\alpha_5 \beta_5} \sim 1$
- $\varepsilon_5 \varepsilon_5 (A_3 A_3 A_{[1} A_2 A_3]) \equiv (A^5)_{33} \sim \varepsilon_{\alpha_1 \dots \alpha_5} \varepsilon_{\beta_1 \dots \beta_5} A_3^{\alpha_1 \beta_1} A_3^{\alpha_2 \beta_2} A_{[1}^{\alpha_3 \beta_3} A_2^{\alpha_4 \beta_4} A_3^{\alpha_5 \beta_5} \sim 1$
- $\varepsilon_5 (A_1 A_{[2} A_3] \tilde{Q}) \equiv (A^3 \tilde{Q})_{11} \sim \varepsilon_{\alpha_1 \dots \alpha_5} A_1^{\alpha_1 \alpha_2} A_{[2}^{\alpha_3 \alpha_4} A_3^{\alpha_5 \beta} \tilde{Q}_\beta^I \sim \square$
- $\varepsilon_5 (A_1 A_{[3} A_1] \tilde{Q}) \equiv (A^3 \tilde{Q})_{12} \sim \varepsilon_{\alpha_1 \dots \alpha_5} A_1^{\alpha_1 \alpha_2} A_{[3}^{\alpha_3 \alpha_4} A_1^{\alpha_5 \beta} \tilde{Q}_\beta^I \sim \square$
- $\varepsilon_5 (A_1 A_{[1} A_2] \tilde{Q}) \equiv (A^3 \tilde{Q})_{13} \sim \varepsilon_{\alpha_1 \dots \alpha_5} A_1^{\alpha_1 \alpha_2} A_{[1}^{\alpha_3 \alpha_4} A_2^{\alpha_5 \beta} \tilde{Q}_\beta^I \sim \square$
- $\varepsilon_5 (A_2 A_{[2} A_3] \tilde{Q}) \equiv (A^3 \tilde{Q})_{21} \sim \varepsilon_{\alpha_1 \dots \alpha_5} A_2^{\alpha_1 \alpha_2} A_{[2}^{\alpha_3 \alpha_4} A_3^{\alpha_5 \beta} \tilde{Q}_\beta^I \sim \square$
- $\varepsilon_5 (A_2 A_{[3} A_1] \tilde{Q}) \equiv (A^3 \tilde{Q})_{22} \sim \varepsilon_{\alpha_1 \dots \alpha_5} A_2^{\alpha_1 \alpha_2} A_{[3}^{\alpha_3 \alpha_4} A_1^{\alpha_5 \beta} \tilde{Q}_\beta^I \sim \square$
- $\varepsilon_5 (A_2 A_{[1} A_2] \tilde{Q}) \equiv (A^3 \tilde{Q})_{23} \sim \varepsilon_{\alpha_1 \dots \alpha_5} A_2^{\alpha_1 \alpha_2} A_{[1}^{\alpha_3 \alpha_4} A_2^{\alpha_5 \beta} \tilde{Q}_\beta^I \sim \square$
- $\varepsilon_5 (A_3 A_{[2} A_3] \tilde{Q}) \equiv (A^3 \tilde{Q})_{31} \sim \varepsilon_{\alpha_1 \dots \alpha_5} A_3^{\alpha_1 \alpha_2} A_{[2}^{\alpha_3 \alpha_4} A_3^{\alpha_5 \beta} \tilde{Q}_\beta^I \sim \square$
- $\varepsilon_5 (A_3 A_{[3} A_1] \tilde{Q}) \equiv (A^3 \tilde{Q})_{32} \sim \varepsilon_{\alpha_1 \dots \alpha_5} A_3^{\alpha_1 \alpha_2} A_{[3}^{\alpha_3 \alpha_4} A_1^{\alpha_5 \beta} \tilde{Q}_\beta^I \sim \square$

We didn't include $\varepsilon_5 (A_3 A_{[1} A_2] \tilde{Q}) \equiv (A^3 \tilde{Q})_{33} \sim \varepsilon_{\alpha_1 \dots \alpha_5} A_3^{\alpha_1 \alpha_2} A_{[1}^{\alpha_3 \alpha_4} A_2^{\alpha_5 \beta} \tilde{Q}_\beta^I$ because the trace of the $SU(3)_A$ adjoint matrix should vanish which imposes the relation

$$(A^3 \tilde{Q})_{11} + (A^3 \tilde{Q})_{22} + (A^3 \tilde{Q})_{33} = 0$$

\mathcal{T}_1' :

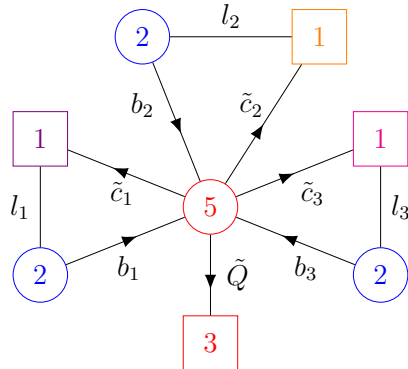

$$\mathcal{W} = -3 \text{ Planar Triangles}$$

$$(3.73)$$

Then we confine the $SU(5)$ using (2.87). Once again we integrate out the massive fields (l_1, l_2 and l_3), we compute the determinant of the meson matrix. We get

\mathcal{T}_2 :

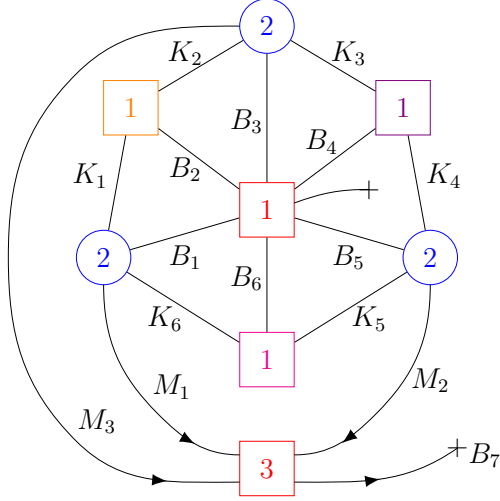

$$\begin{aligned}
\mathcal{W} = & \varepsilon_3 \varepsilon^2 \varepsilon^2 \varepsilon^2 [K_5 M_2 K_2 K_3 M_1^2 \\
& + K_2 M_3 K_4 K_5 M_1^2 + K_1 M_1 K_4 K_5 M_3^2 \\
& + K_6 M_1 K_2 K_3 M_2^2 - K_3 M_3 K_1 K_6 M_2^2 \\
& - K_4 M_2 K_1 K_6 M_3^2 + K_1 M_1 K_5 M_2 K_3 M_3 \\
& + K_6 M_1 K_4 M_2 K_2 M_3] - B_7 B_1 M_1 \\
& - B_7 B_3 M_3 - B_7 B_5 M_2 - 6 \text{ Planar Triangles}
\end{aligned}$$

(3.74)

The next step is to confine the $Usp(2)_{up}$, B_2, B_4 and B_7 get a mass. The result is

\mathcal{T}_3 :

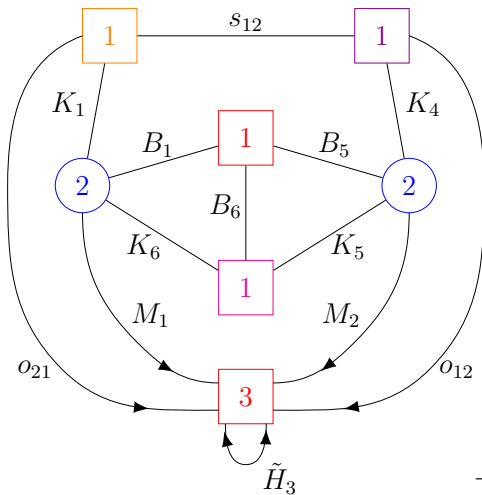

$$\begin{aligned}
\mathcal{W} = & \varepsilon_3 \varepsilon^2 \varepsilon^2 [K_5 M_2 s_{12} M_1^2 \\
& + o_{21} K_4 K_5 M_1^2 + K_1 M_1 K_4 K_5 \tilde{H}_3 \\
& + K_6 M_1 s_{12} M_2^2 - o_{12} K_1 K_6 M_2^2 \\
& - K_4 M_2 K_1 K_6 \tilde{H}_3 + K_1 M_1 K_5 M_2 o_{12} \\
& + K_6 M_1 K_4 M_2 o_{21}] - B_1 B_6 K_6 \\
& - B_5 B_6 K_5 - \varepsilon_3 [o_{21} o_{12} B_1 M_1 \\
& - o_{21} o_{12} B_5 M_2 + o_{21} K_4 B_5 \tilde{H}_3 \\
& - o_{12} K_1 B_1 \tilde{H}_3 + B_1 M_1 s_{12} \tilde{H}_3 + B_5 M_2 s_{12} \tilde{H}_3]
\end{aligned}$$

(3.75)

In the next two steps, we confine $Usp(2)_{left}$ and $Usp(2)_{right}$. It is really similar to the previous step. We obtain

\mathcal{T}_4 :

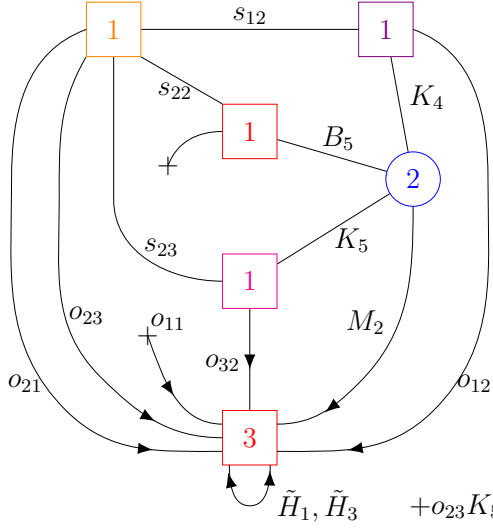

$$\begin{aligned}
\mathcal{W} = & \varepsilon_3 \varepsilon^2 [K_5 M_2 s_{12} \tilde{H}_1 \\
& + o_{21} K_4 K_5 \tilde{H}_1 + o_{23} K_4 K_5 \tilde{H}_3 \\
& + o_{32} s_{12} M_2^2 - o_{12} s_{23} M_2^2 - K_4 M_2 s_{23} \tilde{H}_3 \\
& + o_{23} K_5 M_2 o_{12} + o_{32} K_4 M_2 o_{21}] \\
& + \varepsilon_3 [-o_{21} o_{12} o_{11} - o_{21} o_{12} B_5 M_2 \\
& + o_{21} K_4 B_5 \tilde{H}_3 - o_{12} s_{22} \tilde{H}_3 + o_{11} s_{12} \tilde{H}_3 \\
& + B_5 M_2 s_{12} \tilde{H}_3 + o_{23} o_{32} o_{11} + o_{23} o_{32} B_5 M_2 \\
& + o_{23} K_5 B_5 \tilde{H}_1 + o_{32} s_{22} \tilde{H}_1 - o_{11} s_{23} \tilde{H}_1 - B_5 M_2 s_{23} \tilde{H}_1]
\end{aligned} \tag{3.76}$$

\mathcal{T}_5 :

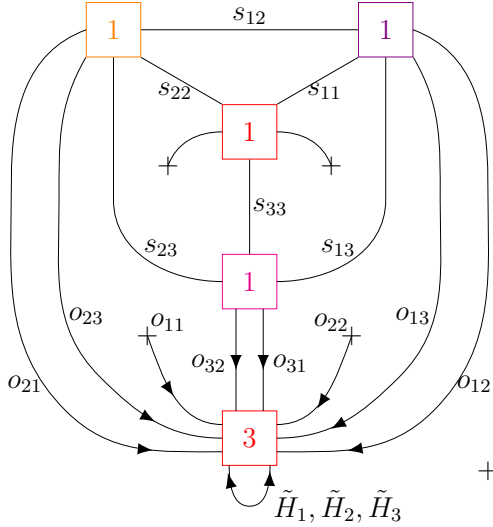

$$\begin{aligned}
\mathcal{W} = & \varepsilon_3 [o_{31} s_{12} \tilde{H}_1 + o_{21} s_{13} \tilde{H}_1 + o_{23} s_{33} \tilde{H}_1 \\
& + o_{32} s_{22} \tilde{H}_1 - o_{11} s_{23} \tilde{H}_1 - o_{22} s_{23} \tilde{H}_1 \\
& - o_{12} s_{23} \tilde{H}_2 + o_{32} s_{12} \tilde{H}_2 - o_{13} s_{33} \tilde{H}_2 \\
& + o_{31} s_{11} \tilde{H}_2 - o_{22} s_{13} \tilde{H}_2 - o_{11} s_{13} \tilde{H}_2 \\
& - o_{13} s_{23} \tilde{H}_3 - o_{21} s_{11} \tilde{H}_3 - o_{12} s_{22} \tilde{H}_3 \\
& + o_{23} s_{13} \tilde{H}_3 + o_{11} s_{12} \tilde{H}_3 + o_{22} s_{12} \tilde{H}_3 \\
& + o_{23} o_{31} o_{12} + o_{32} o_{13} o_{21} - o_{21} o_{12} o_{11} - o_{21} o_{12} o_{22} \\
& + o_{23} o_{32} o_{11} + o_{23} o_{32} o_{22} + o_{13} o_{31} o_{22} + o_{13} o_{31} o_{11}]
\end{aligned} \tag{3.77}$$

The final superpotential can be repackaged in a manifest $SU(2)_A$ invariant way as

$$\mathcal{W} = OS\tilde{H} + O^3, \tag{3.78}$$

where

$$A^3 \tilde{Q} \leftrightarrow O \equiv \begin{pmatrix} o_{11} & o_{12} & o_{13} \\ o_{21} & o_{22} & o_{23} \\ o_{31} & o_{32} & -o_{11} - o_{22} \end{pmatrix}, \quad A^5 \leftrightarrow S \equiv \begin{pmatrix} s_{11} & s_{12} & s_{13} \\ s_{12} & s_{22} & s_{23} \\ s_{13} & s_{23} & s_{33} \end{pmatrix} \quad \text{and} \quad A\tilde{Q}^2 \leftrightarrow \tilde{H} \equiv \begin{pmatrix} \tilde{H}_1 \\ \tilde{H}_2 \\ \tilde{H}_3 \end{pmatrix}$$

O transforms in the adjoint, S as a symmetric 2-tensor and \tilde{H} in the fundamental of $SU(3)_A$. We recover the result of Section 3.1.7 of [46]. The mapping of the chiral ring generators is

$$\begin{array}{cccccc}
\mathcal{T}_1 & \mathcal{T}_{1'} & \mathcal{T}_2 & \mathcal{T}_3 & \mathcal{T}_4 & \mathcal{T}_5 \\
A_1 \tilde{Q}^2 & b_1 b_1 \tilde{Q}^2 & M_1^2 & M_1^2 & \tilde{H}_1 & \tilde{H}_1 \\
A_2 \tilde{Q}^2 & b_2 b_2 \tilde{Q}^2 & M_2^2 & M_2^2 & M_2^2 & \tilde{H}_2 \\
A_3 \tilde{Q}^2 & b_3 b_3 \tilde{Q}^2 & M_3^2 & \tilde{H}_3 & \tilde{H}_3 & \tilde{H}_3 \\
(A^5)_{11} & b_1^2 b_2^2 b_3^2 \tilde{c}_1 & B_3 K_3 & B_5 K_4 & B_5 K_4 & s_{11} \\
(A^5)_{12} & b_3 b_3 \tilde{c}_1 \tilde{c}_2 & K_2 K_3 & s_{12} & s_{12} & s_{12} \\
(A^5)_{13} & b_2 b_2 \tilde{c}_1 \tilde{c}_3 & K_4 K_5 & K_4 K_5 & K_4 K_5 & s_{13} \\
(A^5)_{22} & b_1^2 b_2^2 b_3^2 \tilde{c}_2 & B_1 K_1 & B_1 K_1 & s_{22} & s_{22} \\
(A^5)_{23} & b_1 b_1 \tilde{c}_2 \tilde{c}_3 & K_1 K_6 & K_1 K_6 & s_{23} & s_{23} \\
(A^5)_{33} & b_1^2 b_2^2 b_3^2 \tilde{c}_3 & B_5 K_5 & B_5 K_5 & B_5 K_5 & s_{33} \\
(A^3 \tilde{Q})_{11} & \varepsilon_5 (b_1 b_2^2 b_3^2) b_1 \tilde{Q} & B_1 M_1 & B_1 M_1 & o_{11} & o_{11} \\
(A^3 \tilde{Q})_{12} & b_3 b_3 \tilde{c}_1 \tilde{Q} & K_3 M_3 & o_{12} & o_{12} & o_{12} \\
(A^3 \tilde{Q})_{13} & b_2 b_2 \tilde{c}_1 \tilde{Q} & K_4 M_2 & K_4 M_2 & K_4 M_2 & o_{13} \\
(A^3 \tilde{Q})_{21} & b_3 b_3 \tilde{c}_2 \tilde{Q} & K_2 M_3 & o_{21} & o_{21} & o_{21} \\
(A^3 \tilde{Q})_{22} & \varepsilon_5 (b_2 b_1^2 b_3^2) b_2 \tilde{Q} & B_5 M_2 & B_5 M_2 & B_5 M_2 & o_{22} \\
(A^3 \tilde{Q})_{23} & b_1 b_1 \tilde{c}_2 \tilde{Q} & K_1 M_1 & K_1 M_1 & o_{23} & o_{23} \\
(A^3 \tilde{Q})_{31} & b_2 b_2 \tilde{c}_3 \tilde{Q} & K_5 M_2 & K_5 M_2 & K_5 M_2 & o_{31} \\
(A^3 \tilde{Q})_{32} & b_1 b_1 \tilde{c}_3 \tilde{Q} & K_6 M_1 & K_6 M_1 & o_{32} & o_{32}
\end{array} \quad (3.79)$$

The same phenomenon with degenerate operators appears here, as in Section 3.2.4. In this case they are the operators $B_1 M_1, B_5 M_2$ and $B_3 M_3$ in \mathcal{T}_2 . They are related by the F-term equation of $B_7 : B_1 M_1 + B_5 M_2 + B_3 M_3 = 0$, which reproduces the traceless condition (3.73). To reproduce the correct superpotential in the final frame \mathcal{T}_5 , we use our prescription of Section 3.2.4. Concretely, when we go from \mathcal{T}_3 to \mathcal{T}_4 it is the combination $o_{11} + B_5 M_2$ that enters in the computation of the Pfaffian superpotential. Similarly from \mathcal{T}_4 to \mathcal{T}_5 it is the combination $o_{11} + o_{22}$ that should enter. Taking into account this subtle point, we can recover the final superpotential (3.78) with the correct $SU(3)_A$ global symmetry.

3.3 Sequential deconfinement of $4d\mathcal{N} = 1$ gauge theories

3.3.1 Case study: $USp(6)$ with $\square + 8\square$

In this subsection we study the $4d\mathcal{N} = 1$ $USp(6)$ gauge theory with matter in the antisymmetric representation and 8 fundamentals, that is 4 flavors before turning to the general case in the next subsection. It is known that this theory is self-dual modulo flips [62]. We will prove the self-duality using the basic moves (2.86), (2.88) and (2.105).

Sequential deconfinement

The first step is the deconfinement of the antisymmetric with (2.105). We get the following two frames \mathcal{T}_0 and $\mathcal{T}_{0'}$

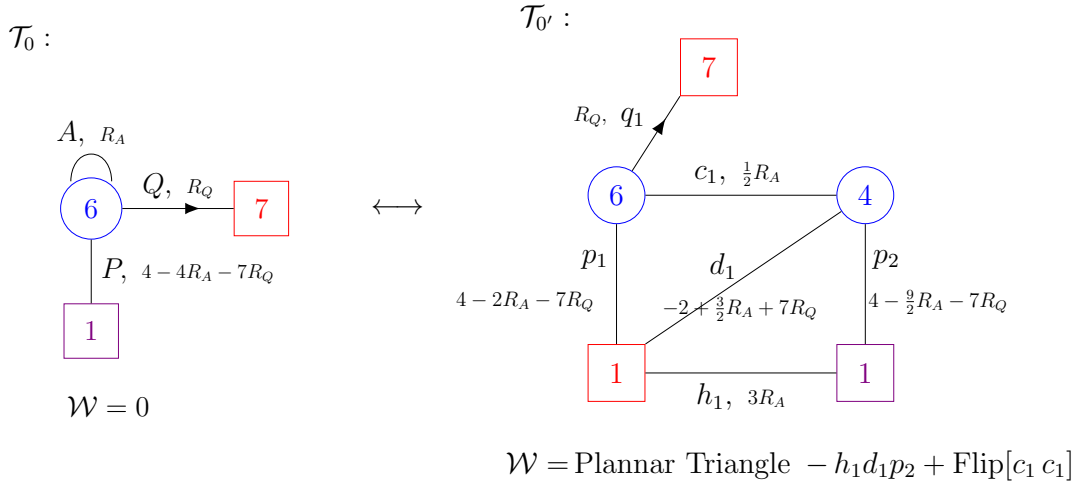

The global symmetry of the original theory is $SU(8) \times U(1)_A \times U(1)_R$. When we split the 8 chirals into $7+1$, we split the $SU(8)$ into $SU(7) \times U(1)_P$. So in the splitted form, the R-charges of the fields should be a function of two variables (for the two global $U(1)$'s that can mix with the $U(1)_R$). We choose to write the R-charges in terms of R_Q and R_A . Then the R-charges of the other fields are determined by the $U(1)_R$ ABJ anomaly⁹ and by the requirement that any superpotential term should have R-charge equal to 2. We have written the R-charges of the fields next to them.

Then we dualize the $USp(6)$ node with (2.86). The fields d_1 and Flipper $[c_1 c_1]$ get a mass. After integrating them out and rescaling the fields to put a $+1$ in front of each term in the superpotential, we get

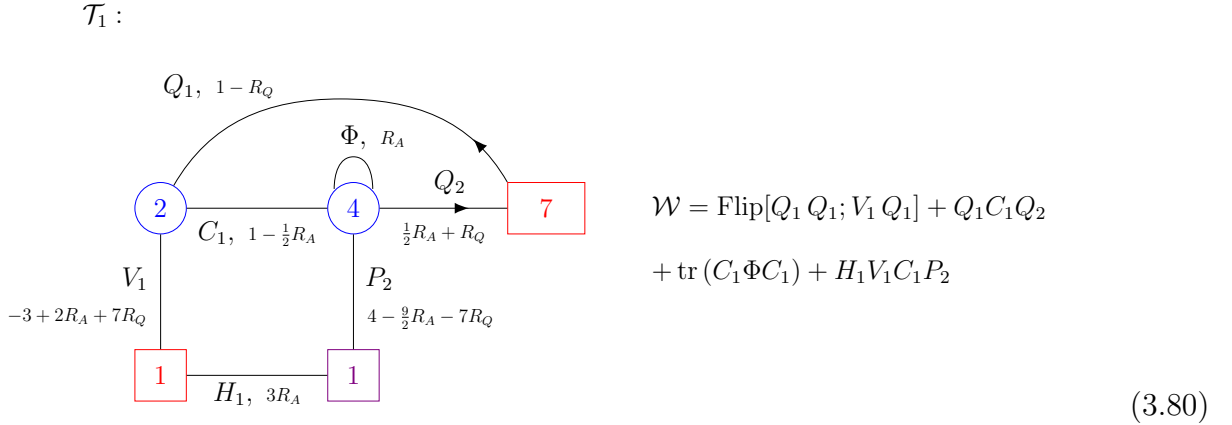

In \mathcal{T}_1 the antisymmetric field, Φ , is traceless because the trace component has been killed by the equation of motion (E.O.M) of the Flipper $[c_1 c_1]$. The mapping of the chiral ring generators after this first step is the following

\mathcal{T}_0	$\mathcal{T}_{0'}$	\mathcal{T}_1	
QQ	$q_1 q_1$	Flipper $[Q_1 Q_1]$	
$\text{tr}(Q A^i Q)$	$\text{tr}(q_1 (c_1 c_1)^i q_1)$	$\text{tr}(Q_2 \Phi^{i-1} Q_2)$	$i = 1, 2$
$\text{tr}(Q A^j P)$	$\text{tr}(q_1 c_1 (c_1 c_1)^j p_2)$	$\text{tr}(Q_2 \Phi^j P_2)$	$j = 0, 1$
$\text{tr}(Q A^2 P)$	$q_1 p_1$	Flipper $[V_1 Q_1]$	
$\text{tr}(A^2)$	$\text{tr}((c_1 c_1)^2)$	$\text{tr}(\Phi^2)$	
$\text{tr}(A^3)$	h_1	H_1	

(3.81)

⁹This is the same as requiring the vanishing of the NSVZ β function.

It can be checked that the mapping (3.81) is consistent with the R-charges of the operators. Now we iterate the procedure.

We now deconfine the traceless antisymmetric field Φ .

\mathcal{T}_1 :

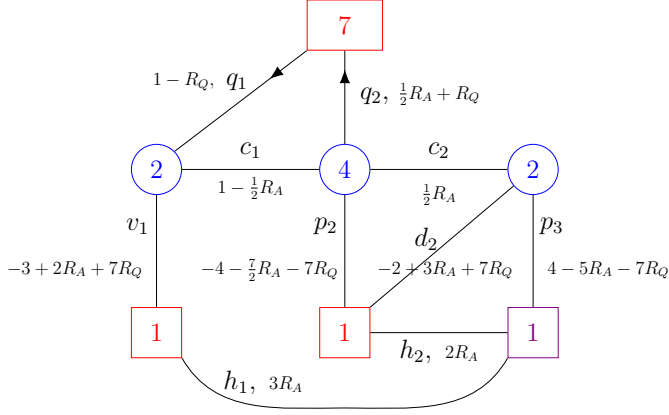

$$\begin{aligned} \mathcal{W} = & \text{Flip}[c_2 c_2; q_1 q_1; v_1 q_1] + q_1 c_1 q_2 \\ & + \text{tr}(c_1 c_2 c_2 c_1) + h_1 v_1 c_1 c_2 p_3 \\ & + h_2 d_2 p_3 + p_2 c_2 d_2 \end{aligned}$$

(3.82)

Now we dualize the $Usp(4)$ node. There will not be any antisymmetric field for the other gauge groups because they are $Usp(2)$ ¹⁰. The fields q_1 , d_2 and Flipper[$c_2 c_2$] get a mass. Moreover, $\text{tr}(c_1 c_2 c_2 c_1)$ becomes a mass term therefore there will be no link between the two $Usp(2)$ gauge groups. After integrating these massive fields out and a rescaling we get

\mathcal{T}_2 :

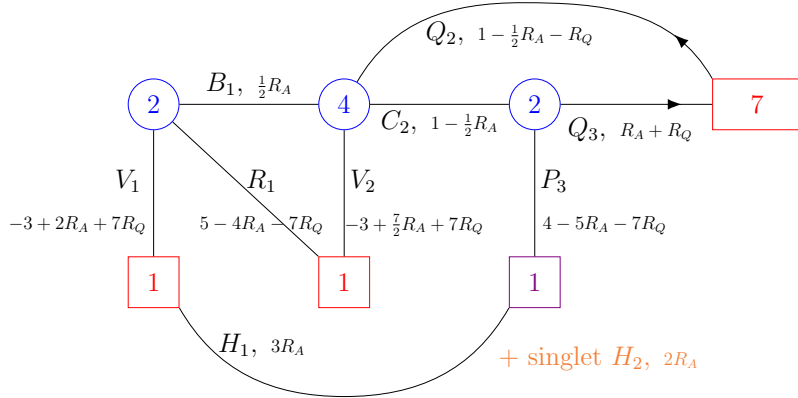

$$\begin{aligned} \mathcal{W} = & \text{Flip}[B_1 B_1; B_1 Q_2 Q_2 B_1; Q_2 Q_2; V_1 B_1 Q_2; V_2 Q_2] + \text{tr}(C_2 \Phi C_2) \\ & + \text{tr}(B_1 C_2 C_2 B_1) + R_1 B_1 V_2 + Q_2 C_2 Q_3 + H_1 V_1 B_1 C_2 P_3 + H_2? \end{aligned}$$

(3.83)

At this step, we face a feature that we call the *degenerate holomorphic operator ambiguity* already eluded in the last section. It arises when we ask what is the operator flipped by the singlet H_2 .

Degenerate holomorphic operator ambiguity

If we apply the rules of Seiberg duality locally in the quiver, as is usually done, using the mapping (2.86), we would conclude that it is $\mathcal{O}_1 = V_2 C_2 P_3$, so the superpotential should contain

¹⁰The dualization creates however singlets that correspond to the trace part of the would be antisymmetric. We call the singlet on the left Flipper[$B_1 B_1$]. The one on the right will receive a mass with the singlet Flipper[$c_2 c_2$] so we do not need to give it a name.

$H_2\mathcal{O}_1$. However, for the quiver at hand, there is another candidate, $\mathcal{O}_2 = V_1R_1$. Both \mathcal{O}_1 and \mathcal{O}_2 are gauge singlets, singlets under the $SU(7)$ flavor symmetry and have R-charge: $R(V_1R_1) = R(V_2C_2P_3) = 2 - 2R(A)$ (which implies that the two operators have the same charges under the flavor $U(1)$'s). Therefore they are degenerate operators.¹¹ So it might be that the precise operator flipped by H_2 is not exactly \mathcal{O}_1 , but some linear combination of \mathcal{O}_1 and \mathcal{O}_2 .

We claim that the correct answer is that the operator flipped by H_2 is $\mathcal{O}_2 = V_1R_1$, instead of the naive \mathcal{O}_1 . Our argument in favor of this statement comes from dualizing some nodes in the quiver, as we will explain soon. So in a sense the fact the the correct operator is not the naive one is due to quantum relations, which become classical relation after Seiberg duality.

Our strategy to decide the correct operator is to use dualities in order to go to a frame where F-term equations can answer the question. In this case, we apply IP S-confining duality (2.88) on the left $Usp(2)$ gauge node of theory \mathcal{T}_2 with the singlet H_2 removed. We consider the same theory with the flipping removed, the question becomes which linear combination of the two degenerate holomorphic operators \mathcal{O}_1 and \mathcal{O}_2 is non zero in the chiral ring. Since the answer, as we will see, is that \mathcal{O}_2 is non zero in the chiral ring, the quantum relation in the unflipped theory is $\mathcal{O}_1 = 0$.

The $Usp(2)$ we dualize is coupled to 6 fundamentals and so it confines, producing a traceless antisymmetric field B (the trace part is killed by the flipper $\text{Flipper}[B_1 B_1]$). We get

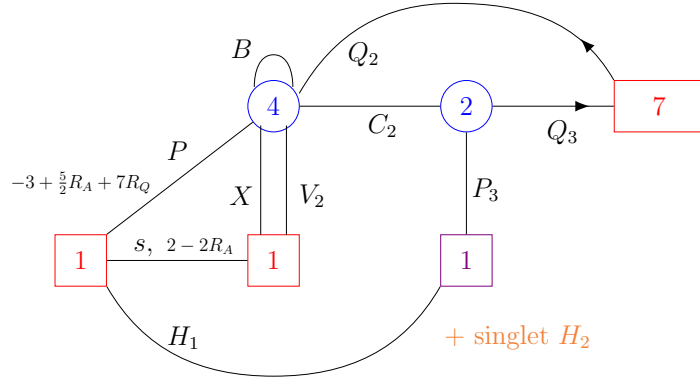

$$\mathcal{W} = \text{Flip}[Q_2 B Q_2; Q_2 Q_2; P Q_2; V_2 Q_2] + \text{tr}(C_2 B C_2) + X V_2 + Q_2 C_2 Q_3$$

$$+ H_1 P C_2 P_3 + H_2? + \text{Pfaff} \begin{pmatrix} B & \vdots & P & \vdots & X \\ \cdots & \cdots & \cdots & \cdots & \cdots \\ & & & 0 & s \\ & & \cdots & \cdots & \cdots \\ & & & & 0 \end{pmatrix} \quad (3.84)$$

The Pfaffian term gives: $\text{Pfaff} \begin{pmatrix} B & \vdots & P & \vdots & X \\ \cdots & \cdots & \cdots & \cdots & \cdots \\ & & & 0 & s \\ & & \cdots & \cdots & \cdots \\ & & & & 0 \end{pmatrix} \sim \varepsilon_4(B^2)s + \varepsilon_4(BPX)$

The fields X and V_2 are massive. The E.O.M of X gives: $V_2 + BP = 0$.

In addition, the F-term equation for the singlet H_1 gives: $PC_2P_3 = 0$.

¹¹Let us emphasize that there is no ambiguity with H_1 because there is only one operator which is singlet under the gauge symmetry, the $SU(7)$ flavor symmetry and has R-charge equal to $2 - 3R(A)$. This operator is $V_1B_1C_2P_3$.

Combining these two informations, we can resolve the ambiguity about the operators \mathcal{O}_1 and \mathcal{O}_2 . Indeed in this frame these operators become

$$\mathcal{O}_1 = V_2 C_2 P_3 \longrightarrow V_2 C_2 P_3 \stackrel{\text{E.O.M } X}{=} B P C_2 P_3 \stackrel{\text{F-term } H_1}{\simeq} 0 \quad (3.85)$$

$$\mathcal{O}_2 = V_1 R_1 \longrightarrow s \quad (3.86)$$

The symbol \simeq in the last of equality in (3.85) means an equivalence in the chiral ring.

Therefore we conclude that the non-zero operator in the chiral ring is $\mathcal{O}_2 = V_1 R_1$ and so it should be this one that enters in the superpotential with H_2 .

Fully deconfined frame

We now go back to our deconfining procedure, and dualize the right $Usp(2)$ node in \mathcal{T}_2 using (2.86). We reach a frame that we call “fully deconfined” as in [85].

\mathcal{T}_{Dec} :

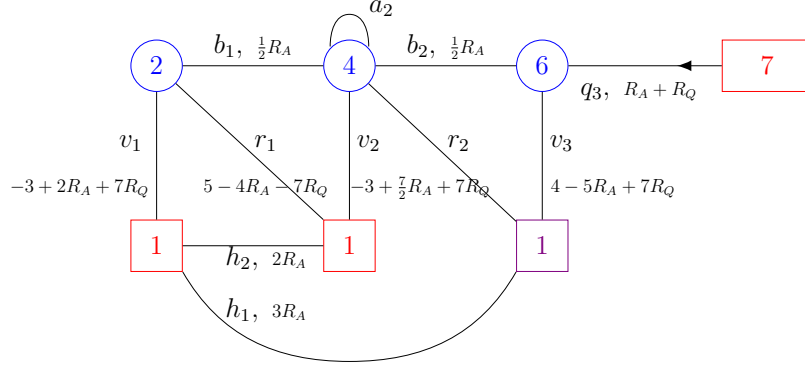

$$\begin{aligned} \mathcal{W} = & \text{Flip}[b_1 b_1; b_2 b_2; b_1 b_2 q_3 q_3 b_2 b_1; b_2 q_3 q_3 b_2; q_3 q_3; v_1 b_1 b_2 q_3; v_2 b_2 q_3; v_3 q_3] \\ & + \text{tr}(b_1 a_2 b_1) + \text{tr}(b_2 a_2 b_2) + r_1 b_1 v_2 + r_2 b_2 v_3 + h_1 v_1 b_1 r_2 + h_2 v_1 r_1 \end{aligned} \quad (3.87)$$

The antisymmetric field a_2 is traceless, as all the antisymmetric field of Usp that will appear in this paper. Once again there is the question of the operator flipped by h_2 because $v_2 r_2$ has the same quantum numbers as $v_1 r_1$. Using the same procedure of confining from the left, we would obtain that the operator $v_2 r_2$ is 0 on the chiral ring. Therefore we claim that the correct final superpotential is the one with this switching procedure and not the one that we would have got using naive iteration of IP dualities. The final mapping of the chiral ring generators is

\mathcal{T}_1	\mathcal{T}'	\mathcal{T}_2	\mathcal{T}_{Dec}
Flipper[$Q_1 Q_1$]	Flipper[$q_1 q_1$]	Flipper[$B_1 Q_2 Q_2 B_1$]	Flipper[$b_1 b_2 q_3 q_3 b_2 b_1$]
$Q_2 Q_2$	$q_2 q_2$	Flipper[$Q_2 Q_2$]	Flipper[$b_2 q_3 q_3 b_2$]
$\text{tr}(Q_2 \Phi Q_2)$	$\text{tr}(q_2 (c_2 c_2) q_2)$	$Q_3 Q_3$	Flipper[$q_3 q_3$]
$Q_2 P_2$	$q_2 c_2 p_3$	$Q_3 P_3$	Flipper[$v_3 q_3$]
$\text{tr}(Q_2 \Phi P_2)$	$q_2 p_2$	Flipper[$V_2 Q_2$]	Flipper[$v_2 b_2 q_3$]
Flipper[$V_1 Q_1$]	Flipper[$v_1 q_1$]	Flipper[$V_1 B_1 Q_2$]	Flipper[$v_1 b_1 b_2 q_3$]
$\text{tr}(\Phi^2)$	h_2	H_2	h_2
H_1	h_1	H_1	h_1

Combining the two mappings (3.81) and (3.88), we get the mapping between \mathcal{T}_0 and \mathcal{T}_{Dec}

$$\begin{array}{l}
\mathcal{T}_1 \\
\text{tr}(Q A^i Q) \\
\text{tr}(Q A^j P) \\
\text{tr}(A^k)
\end{array}
\iff
\begin{array}{l}
\mathcal{T}_{DEC} \\
\text{Flipper}[b_{i+1} b_{i+2} \dots b_2 q_3 q_3 b_2 \dots b_{i+2} b_{i+1}] \\
\text{Flipper}[v_{3-j} b_{3-j} b_{3-j+1} \dots b_2 q_3] \\
h_{N+1-k}
\end{array}
\begin{array}{l}
i = 0, 1, 2 \\
j = 0, 1, 2 \\
k = 2, 3
\end{array}
\quad (3.89)$$

Self-duality

We already said that this theory is self-dual [62]. Let us see now how we can use our \mathcal{T}_{Dec} frame to prove the self-duality. The strategy is to *reconfine* the quiver tail. We notice that the left $Usp(2)$ has 6 fundamentals, so we start confining from the left. The effect of this confinement is to kill the antisymmetric field a_2 . In addition, the fields $\text{Flipper}[b_1 b_1]$, v_2 and h_2 get a mass and we produce a Pfaffian superpotential as in (3.84). We get

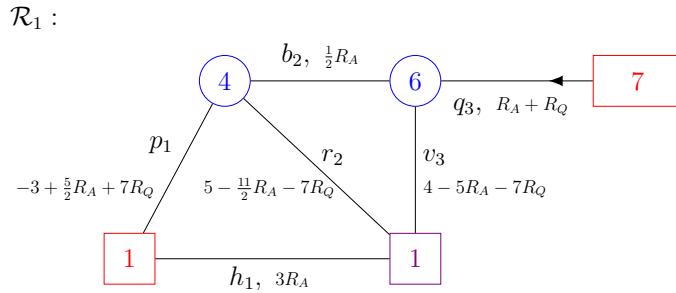

$$\mathcal{W} = \text{Flip}[b_2 b_2; b_2 b_2 b_2 q_3 q_3 b_2; b_2 q_3 q_3 b_2; q_3 q_3; p_1 b_2 q_3; v_3 q_3; p_1 b_2 b_2 b_2 q_3] + r_2 b_2 v_3 + h_1 p_1 r_2 \quad (3.90)$$

Then we can confine the $Usp(4)$ node. We will reach the self-dual frame of the original theory. Indeed, we produce a traceless antisymmetric field, B , for the $Usp(6)$ and the fields h_1 , $\text{Flipper}[b_2 b_2]$ and v_3 get a mass. The final quiver reads

$\mathcal{R}_2 \equiv \mathcal{R}_{final} :$

$$\mathcal{W} = \sum_{j=1}^3 \text{Flip}[q_3 B^{3-j} q_3] + \sum_{j=1}^3 \text{Flip}[p_2 B^{j-1} q_3] \quad (3.91)$$

We can repackage the final result into a manifestly $SU(8)$ invariant way

$\mathcal{R}_{final} :$

$$\mathcal{W} = \sum_{j=1}^3 \text{Flip}[\tilde{Q} B^{3-j} \tilde{Q}] \quad (3.92)$$

Where we define

$$\text{Flipper}[\tilde{Q} B^{3-j} \tilde{Q}] = \left(\begin{array}{c} \overbrace{\text{Flipper}[q_3 B^{3-j} q_3]}^7 \quad \vdots \quad \overbrace{\text{Flipper}[p_2 B^{3-j} q_3]}^1 \\ \dots \quad \vdots \quad \dots \\ \vdots \quad \quad \quad 0 \end{array} \right) \left. \begin{array}{l} \vdots \\ \vdots \\ \vdots \end{array} \right\} \begin{array}{l} 7 \\ \vdots \\ 1 \end{array}, \quad (3.93)$$

$$\tilde{Q} = \left(\overbrace{\quad}^7 \quad \vdots \quad \overbrace{\quad}^1 \right) \quad (3.94)$$

During this sequential reconfinement, from \mathcal{T}_{Dec} and \mathcal{R}_{final} , the mapping is

$$\begin{array}{ccc}
\mathcal{T}_{Dec} & & \mathcal{R}_1 & & \mathcal{R}_{final} \\
\text{Flipper}[b_1 b_2 q_3 \ q_3 b_2 b_1] & & \text{Flipper}[b_2 b_2 b_2 q_3 \ q_3 b_2] & & \text{Flipper}[q_3 \ B^2 \ q_3] \\
\text{Flipper}[b_2 q_3 \ q_3 b_2] & & \text{Flipper}[b_2 q_3 \ q_3 b_2] & & \text{Flipper}[q_3 \ B \ q_3] \\
\text{Flipper}[q_3 \ q_3] & & \text{Flipper}[q_3 \ q_3] & & \text{Flipper}[q_3 \ q_3] \\
\text{Flipper}[v_3 \ q_3] & \iff & \text{Flipper}[v_3 \ q_3] & \iff & \text{Flipper}[p_2 \ B^2 \ q_3] \\
\text{Flipper}[v_2 b_2 q_3] & & \text{Flipper}[p_1 b_2 b_2 b_2 q_3] & & \text{Flipper}[p_2 \ B \ q_3] \\
\text{Flipper}[v_1 b_1 b_2 q_3] & & \text{Flipper}[p_1 b_2 q_3] & & \text{Flipper}[p_2 \ q_3] \\
h_2 & & \text{tr}(b_2 b_2)^2 & & \text{tr}(B^2) \\
h_1 & & h_1 & & \text{tr}(B^3)
\end{array} \quad (3.95)$$

Comparing with the mapping (3.89), we read the mapping for the self-duality

$$\begin{array}{ccc}
\mathcal{T}_1 & & \mathcal{R}_{final} \\
\text{tr}(Q A^i Q) & \iff & \text{Flipper}[q_3 \ B^{2-i} \ q_3] \quad i = 0, \dots, 2 \\
\text{tr}(Q A^i P) & & \text{Flipper}[q_3 \ B^{2-i} \ p_2] \quad i = 0, \dots, 2 \\
\text{tr}(A^k) & & \text{tr}(B^k) \quad k = 2, \dots, 3
\end{array} \quad (3.96)$$

This is precisely the mapping given in [62].

Notice that in the reconfinement the precise operator flipped by the singlet H_2 was crucial to obtain the duality with the correct amount of gauge singlets. In the next section we generalize our discussion to arbitrary N and F .

3.3.2 General case: $USp(2N)$ with $\square + 2F \square$

In this section we study the general case. The $USp(2N)$ gauge theory with a traceless anti-symmetric field A and $2F$ complex chiral fields (the number of fundamentals should be even to avoid the global anomaly).

We proceed as in [85] to derive a chain of $2N$ dual frames consisting of quiver theories, with number of gauge nodes ranging from 1 to N . Let us start with the first \mathcal{T}_0 quiver

$$\begin{array}{ccc}
\mathcal{T}_0 : & & \\
\begin{array}{c} \text{A} \\ \circlearrowleft \\ \text{2N} \end{array} \xrightarrow{\quad} \boxed{2F} & \equiv & \begin{array}{c} \text{A} \\ \circlearrowleft \\ \text{2N} \end{array} \xrightarrow{\quad Q} \boxed{2F-1} \\
\mathcal{W} = 0 & & \begin{array}{c} P \\ \downarrow \\ \boxed{1} \end{array} \\
& & \mathcal{W} = 0
\end{array} \quad (3.97)$$

Deconfine and dualize: first step

We start by using the deconfinement (2.105), we obtain

$\mathcal{T}_{0'}$:

$\mathcal{W} = \text{Plannar Triangle} - h_1 d_1 p_2 + \text{Flip}[c_1 c_1]$

(3.98)

Then we dualize the $USp(2N)$ node with (2.86). This step is the same as in (3.80).

\mathcal{T}_1 :

$\mathcal{W} = \text{Flip}[Q_1 Q_1; V_1 Q_1] + Q_1 C_1 Q_2$
 $+ \text{tr}(C_1 \Phi C_1) + H_1 V_1 C_1 P_2$

(3.99)

The mapping of the chiral ring generators after this first step is the following

\mathcal{T}_0	$\mathcal{T}_{0'}$	\mathcal{T}_1	
QQ	$q_1 q_1$	$\text{Flipper}[Q_1 Q_1]$	
$\text{tr}(QA^i Q)$	$\text{tr}(q_1 (c_1 c_1)^i q_1)$	$\text{tr}(Q_2 \Phi^{i-1} Q_2)$	$i = 1, \dots, N-1$
$\text{tr}(QA^j P)$	$\text{tr}(q_1 c_1 (c_1 c_1)^j p_2)$	$\text{tr}(Q_2 \Phi^j P_2)$	$j = 0, \dots, N-2$
$\text{tr}(QA^{N-1} P)$	$q_1 p_1$	$\text{Flipper}[V_1 Q_1]$	
$\text{tr}(A^m)$	$\text{tr}((c_1 c_1)^m)$	$\text{tr}(\Phi^m)$	$m = 2, \dots, N-1$
$\text{tr}(A^N)$	h_1	H_1	

(3.100)

Now we iterate the procedure. We deconfine the traceless antisymmetric field, Φ and then we dualize. Let us write explicitly another step and then it will be enough to obtain the general story.

Second step

After the deconfinement we get

$\mathcal{T}_1 :$

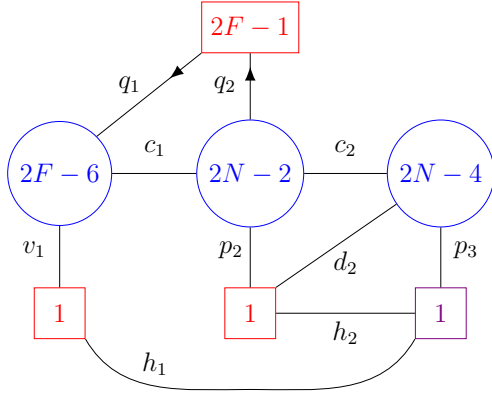

$$\begin{aligned} \mathcal{W} = & \text{Flip}[c_2 c_2; q_1 q_1; v_1 q_1] + q_1 c_1 q_2 \\ & + \text{tr}(c_1 c_2 c_2 c_1) + h_1 v_1 c_1 c_2 p_3 \\ & + h_2 d_2 p_3 + p_2 c_2 d_2 \end{aligned}$$

(3.101)

Now we dualize the $USp(2N-2)$ node. The fields q_1 , d_2 and $\text{Flipper}[c_2 c_2]$ get a mass. In addition $\text{tr}(c_1 c_2 c_2 c_1)$ becomes a mass term therefore there will be no link between the $USp(2F-6)$ and $USp(2N-4)$ gauge group. The result of the integration out (and rescaling) is

$\mathcal{T}_2 :$

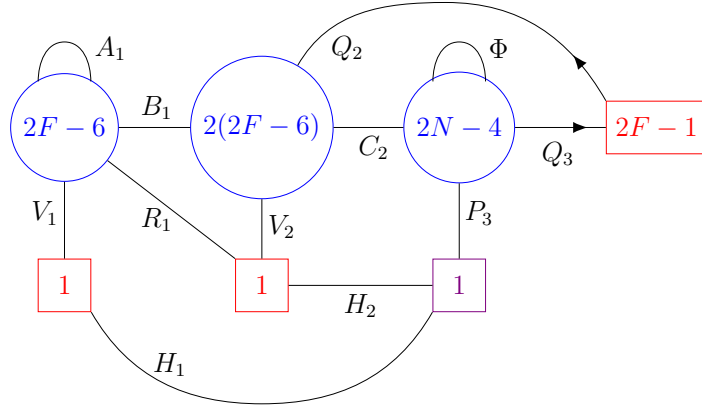

$$\begin{aligned} \mathcal{W} = & \text{Flip}[B_1 B_1; B_1 Q_2 Q_2 B_1; Q_2 Q_2; V_1 B_1 Q_2; V_2 Q_2] + \text{tr}(C_2 \Phi C_2) + \text{tr}(B_1 A_1 B_1) \\ & + \text{tr}(B_1 C_2 C_2 B_1) + R_1 B_1 V_2 + Q_2 C_2 Q_3 + H_1 V_1 B_1 C_2 P_3 + H_2 V_2 C_2 P_3 \end{aligned}$$

(3.102)

We recall that the antisymmetric field A_1 is traceless, as well as Φ .

The mapping after this second step is given by¹²

\mathcal{T}_1	\mathcal{T}_1'	\mathcal{T}_2	
Flipper[$Q_1 Q_1$]	Flipper[$q_1 q_1$]	Flipper[$B_1 Q_2 Q_2 B_1$]	
$Q_2 Q_2$	$q_2 q_2$	Flipper[$Q_2 Q_2$]	
$\text{tr}(Q_2 \Phi^{i-1} Q_2)$	$\text{tr}(q_2 (c_2 c_2)^{i-1} q_2)$	$\text{tr}(Q_3 \Phi^{i-2} Q_3)$	$i = 2, \dots, N-1$
$\text{tr}(Q_2 \Phi^j P_2)$	$\text{tr}(q_2 c_2 (c_2 c_2)^j p_3)$	$\text{tr}(Q_3 \Phi^j P_3)$	$j = 0, \dots, N-3$
$\text{tr}(Q_2 \Phi^{N-2} P_2)$	$q_2 p_2$	Flipper[$V_2 Q_2$]	
Flipper[$V_1 Q_1$]	Flipper[$v_1 q_1$]	Flipper[$V_1 B_1 Q_2$]	
$\text{tr}(\Phi^m)$	$\text{tr}((b_2 b_2)^m)$	$\text{tr}(\Phi^m)$	$m = 2, \dots, N-2$
$\text{tr}(\Phi^{N-1})$	h_2	H_2	
H_1	h_1	H_1	

(3.103)

¹²Using the table of R-charges of the fields given in appendix B in Table B.1, it is easy to check that the mapping is consistent.

After k steps

After the iteration of k steps, we get the following quiver

$\mathcal{T}_k :$

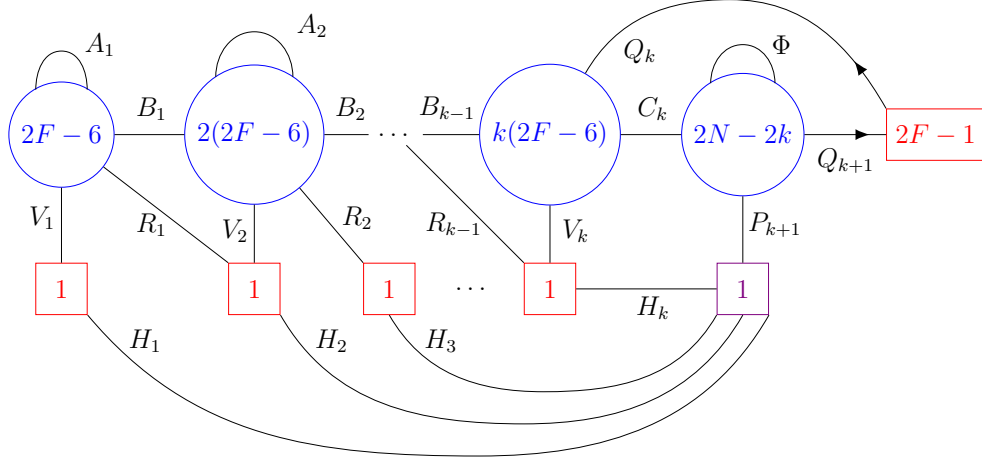

$$\begin{aligned}
\mathcal{W} = & \sum_{j=1}^{k-1} \text{Flip}[B_j B_j] + \sum_{i=1}^k \text{Flip}[B_i B_{i+1} \dots B_{k-1} Q_k Q_k B_{k-1} \dots B_{i+1} B_i] \\
& + \sum_{i=1}^k \text{Flip}[V_i B_i B_{i+1} \dots B_{k-1} Q_k] + \sum_{j=1}^{k-1} R_j B_j V_{j+1} + \sum_{j=1}^{k-1} \text{tr}(B_j A_j B_j) + \sum_{l=1}^{k-2} \text{tr}(B_l A_{l+1} B_l) \\
& + \text{tr}(C_k \Phi C_k) + \text{tr}(B_{k-1} C_k C_k B_{k-1}) + Q_k C_k Q_{k+1} + \sum_{i=1}^k H_i V_i B_i B_{i+1} \dots B_{k-1} C_k P_{k+1}
\end{aligned} \tag{3.104}$$

The last term in the superpotential should be taken with a grain of salt. Indeed as explained in the appendix B, when k is great enough some operators become degenerate with $V_i B_i B_{i+1} \dots B_{k-1} C_k P_{k+1}$ and then the superpotential should be modified. This is the *degenerate holomorphic operator ambiguity* that we described in (3.83). Since it is a k -dependent statement, we decided to be cavalier when writing this term in (3.104) and write the modified version in \mathcal{T}_{N-1} .

The mapping of the chiral ring generators is the following

$$\begin{array}{ccc}
\mathcal{T}_{(k-1)'} & & \mathcal{T}_k \\
\text{Flipper}[b_j b_{j+1} \dots b_{k-2} q_{k-1} q_{k-1} b_{k-2} \dots b_{j+1} b_j] & \text{Flipper}[B_j B_{j+1} \dots B_{k-1} Q_k Q_k B_{k-1} \dots B_{j+1} B_j] & j = 1, \dots, k-1 \\
\text{Flipper}[v_j b_j \dots b_{k-2} q_{k-1}] & \text{Flipper}[V_j B_j \dots B_{k-1} Q_k] & j = 1, \dots, k-1 \\
h_{1, \dots, k} & H_{1, \dots, k} & \\
q_k q_k & \text{Flipper}[Q_k Q_k] & \\
\text{tr}(q_k (c_k c_k)^{i-k+1} q_k) & \text{tr}(Q_{k+1} \Phi^{i-k} Q_{k+1}) & i = k, \dots, N-1 \\
\text{tr}(q_k c_k (c_k c_k)^j p_{k+1}) & \text{tr}(Q_{k+1} \Phi^j P_{k+1}) & j = 0, \dots, N-k-1 \\
q_k p_k & \text{Flipper}[V_k Q_k] & \\
\text{tr}((c_k c_k)^m) & \text{tr}(\Phi^m) & m = 2, \dots, N-k
\end{array} \tag{3.105}$$

After $N-1$ steps

\mathcal{T}_{N-1} :

$$\begin{aligned}
\mathcal{W} = & \sum_{j=1}^{N-2} \text{Flip}[B_j B_j] + \sum_{i=1}^{N-1} \text{Flip}[B_i B_{i+1} \dots B_{N-2} Q_{N-1} Q_{N-1} B_{N-2} \dots B_{i+1} B_i] \\
& + \sum_{i=1}^{N-1} \text{Flip}[V_i B_i B_{i+1} \dots B_{N-2} Q_{N-1}] + \sum_{j=1}^{N-2} R_j B_j V_{j+1} + \sum_{j=1}^{N-2} \text{tr}(B_j A_j B_j) + \sum_{l=1}^{N-3} \text{tr}(B_l A_{l+1} B_l) \\
& + \text{tr}(B_{N-2} C_{N-1} C_{N-1} B_{N-2}) + Q_{N-1} C_{N-1} Q_N + H_1 V_1 B_1 \dots B_{N-2} C_{N-1} P_N + \sum_{i=2}^{N-1} H_i V_i B_1 \dots B_{N-1-i} R_{N-i}
\end{aligned} \tag{3.106}$$

The last term in the superpotential is the one after switching, see Appendix B. Since the last node is $Usp(2)$, there is no antisymmetric and we can directly use (2.86).

Final step and fully deconfined frame

\mathcal{T}_{Dec} :

$$\begin{aligned}
\mathcal{W} = & \sum_{j=1}^{N-1} \text{Flip}[b_j b_j] + \sum_{i=1}^N \text{Flip}[b_i b_{i+1} \dots b_{N-1} q_N q_N b_{N-1} \dots b_{i+1} b_i; v_i b_i b_{i+1} \dots b_{N-1} q_N] \\
& + \sum_{j=1}^{N-1} r_j b_j v_{j+1} + \sum_{j=1}^{N-1} \text{tr}(b_j a_j b_j) + \sum_{l=1}^{N-2} \text{tr}(b_l a_{l+1} b_l) + \sum_{j=1}^{N-1} h_j v_1 b_1 \dots b_{N-1-j} r_{N-j}
\end{aligned} \tag{3.107}$$

We have obtained the fully “deconfined” frame. The mapping is

$$\begin{array}{ccc}
\begin{array}{c} \mathcal{T}_{N-1} \\ \text{Flipper}[B_j B_{j+1} \dots B_{N-2} Q_{N-1} Q_{N-1} B_{N-2} \dots B_{j+1} B_j] \\ \text{Flipper}[V_j B_j \dots B_{N-2} Q_{N-1}] \\ H_{1, \dots, N-1} \\ Q_N Q_N \\ Q_N P_N \end{array} & \iff & \begin{array}{c} \mathcal{T}_{DEC} \\ \text{Flipper}[b_j b_{j+1} \dots b_{N-1} q_N q_N b_{N-1} \dots b_{j+1} b_j] \\ \text{Flipper}[v_j B_j \dots b_{N-1} q_N] \\ h_{1, \dots, N-1} \\ \text{Flipper}[q_N q_N] \\ \text{Flipper}[v_N q_N] \end{array} \quad \begin{array}{l} j = 1, \dots, N-1 \\ j = 1, \dots, N-1 \end{array}
\end{array} \quad (3.108)$$

Collecting all the mappings, we write the mapping from the \mathcal{T}_0 frame to \mathcal{T}_{Dec}

$$\begin{array}{ccc}
\begin{array}{c} \mathcal{T}_0 \\ \text{tr}(Q A^i Q) \\ \text{tr}(Q A^j P) \\ \text{tr}(A^k) \end{array} & \iff & \begin{array}{c} \mathcal{T}_{DEC} \\ \text{Flipper}[b_{i+1} b_{i+2} \dots b_{N-1} q_N q_N b_{N-1} \dots b_{i+2} b_{i+1}] \\ \text{Flipper}[v_{N-j} b_{N-j} b_{N-j+1} \dots b_{N-1} q_N] \\ h_{N+1-k} \end{array} \quad \begin{array}{l} i = 0, \dots, N-1 \\ j = 0, \dots, N-1 \\ k = 2, \dots, N \end{array}
\end{array} \quad (3.109)$$

In the ‘‘deconfined’’ frame, all chiral ring generators are elementary gauge singlets.

3.4 Reconfinement and self-duality for $USp(2N)$ with $\square + 8\square$

As reviewed in (2.96), the USp theory in the $F = 4$ case is known to be self-dual modulo flips. In this section we use our \mathcal{T}_{Dec} frame (3.107) to prove this result. Let us rewrite first (3.107) specifying $F = 4$:

\mathcal{R}_0 :

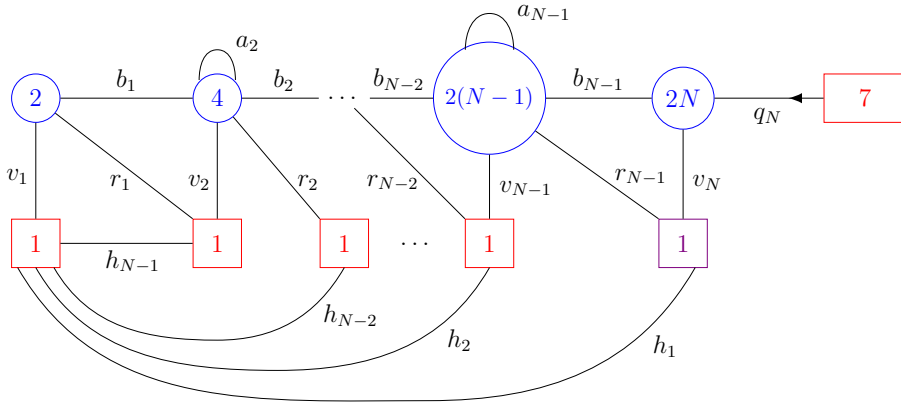

$$\begin{aligned}
\mathcal{W} &= \sum_{j=1}^{N-1} \text{Flip}[b_j b_j] + \sum_{i=1}^N \text{Flip}[b_i b_{i+1} \dots b_{N-1} q_N q_N b_{N-1} \dots b_{i+1} b_i; v_i b_i b_{i+1} \dots b_{N-1} q_N] \\
&+ \sum_{j=1}^{N-1} r_j b_j v_{j+1} + \sum_{j=1}^{N-1} \text{tr}(b_j a_j b_j) + \sum_{l=1}^{N-2} \text{tr}(b_l a_{l+1} b_l) + \sum_{j=1}^{N-1} h_j v_1 b_1 \dots b_{N-1-j} r_{N-j}
\end{aligned} \quad (3.110)$$

$$\begin{array}{l}
\mathcal{T}_0 \\
\text{tr}(Q A^i Q) \\
\text{tr}(Q A^j P) \\
\text{tr}(A^k)
\end{array}
\iff
\begin{array}{l}
\mathcal{R}_0 \\
\text{Flipper}[b_{j+1}b_{j+2}\dots b_{N-1}q_N q_N b_{N-1}\dots b_{j+2}b_{j+1}] \\
\text{Flipper}[v_{N-j}b_{N-j}b_{N-j+1}\dots b_{N-1}q_N] \\
h_{N+1-k}
\end{array}
\begin{array}{l}
j = 0, \dots, N-1 \\
j = 0, \dots, N-1 \\
k = 2, \dots, N
\end{array}
\quad (3.111)$$

We see that the $USp(2)$ gauge group is coupled to $4 + 1 + 1$ chiral fields in the fundamental representation and so it confines (2.88). This step is similar as in (3.90). The confinement will give a mass to the traceless antisymmetric field a_2 as well as v_2 , $\text{Flipper}[b_1 b_1]$ and h_{N-1} . The result after integrating them out (See discussion below (3.84)) is

\mathcal{R}_1 :

$$\begin{aligned}
\mathcal{W} = & \sum_{j=2}^{N-1} \text{Flip}[b_j b_j] + \text{Flip}[b_2 b_2 b_2 \dots b_{N-1} q_N q_N b_{N-1} \dots b_2] + \sum_{i=2}^N \text{Flip}[b_i b_{i+1} \dots b_{N-1} q_N q_N b_{N-1} \dots b_{i+1} b_i] \\
& + \text{Flip}[l_1 p_1 b_2 \dots b_{N-1} q_N; p_1 b_2 b_2 b_2 \dots b_{N-1} q_N] + \sum_{i=3}^N \text{Flip}[v_i b_i b_{i+1} \dots b_{N-1} q_N] + \sum_{i=2}^{N-1} r_i b_i v_{i+1} \\
& + \sum_{i=3}^{N-1} \text{tr}(b_i a_i b_i) + \sum_{i=2}^{N-2} \text{tr}(b_i a_{i+1} b_i) + \sum_{i=1}^{N-2} h_i p_1 b_2 \dots b_{N-1-i} r_{N-i}
\end{aligned}
\quad (3.112)$$

The mapping of the chiral ring generators is

$$\begin{array}{l}
R_0 \\
\text{Flipper}[b_1 b_2 \dots b_{N-1} q_N q_N b_{N-1} \dots b_2 b_1] \\
\text{Flipper}[b_{j+1} b_{j+2} \dots b_{N-1} q_N q_N b_{N-1} \dots b_{j+2} b_{j+1}] \\
\text{Flipper}[v_{N-j} b_{N-j} b_{N-j+1} \dots b_{N-1} q_N] \\
\text{Flipper}[v_2 b_2 b_3 \dots b_{N-1} q_N] \\
\text{Flipper}[v_1 b_1 b_2 \dots b_{N-1} q_N] \\
h_i \\
h_{N-1}
\end{array}
\iff
\begin{array}{l}
R_1 \\
\text{Flipper}[b_2 b_2 b_2 b_2 \dots b_{N-1} q_N q_N b_{N-1} \dots b_2 b_1] \\
\text{Flipper}[b_{j+1} b_{j+2} \dots b_{N-1} q_N q_N b_{N-1} \dots b_{j+2} b_{j+1}] \\
\text{Flipper}[v_{N-j} b_{N-j} b_{N-j+1} \dots b_{N-1} q_N] \\
\text{Flipper}[p_1 b_2 b_2 b_2 b_3 \dots b_{N-1} q_N] \\
\text{Flipper}[p_1 b_2 \dots b_{N-1} q_N] \\
h_i \\
\text{tr}(b_2 b_2)^2
\end{array}
\begin{array}{l}
j = 1, \dots, N-1 \\
j = 0, \dots, N-3 \\
i = 1, \dots, N-2
\end{array}
\quad (3.113)$$

We can now iterate. Indeed the $USp(4)$ group is coupled to $6 + 1 + 1$ fundamentals and so it also confines

$\mathcal{R}_2 :$

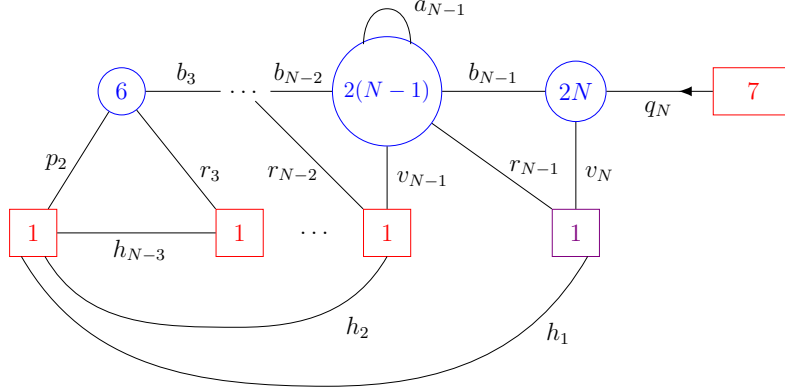

$$\begin{aligned}
\mathcal{W} = & \sum_{j=3}^{N-1} \text{Flip}[b_j b_j] + \text{Flip}[(b_3 b_3)^3 b_4 \dots b_{N-1} q_N q_N b_{N-1} \dots b_4; (b_3 b_3)^2 b_4 \dots b_{N-1} q_N q_N b_{N-1} \dots b_4] \\
& + \sum_{i=3}^N \text{Flip}[b_i b_{i+1} \dots b_{N-1} q_N q_N b_{N-1} \dots b_{i+1} b_i] + \text{Flip}[p_2 b_3 \dots b_{N-1} q_N; p_2 (b_3 b_3) b_3 \dots b_{N-1} q_N] \\
& + \text{Flip}[p_2 (b_3 b_3)^2 b_3 \dots b_{N-1} q_N] + \sum_{i=4}^N \text{Flip}[v_i b_i b_{i+1} \dots b_{N-1} q_N] + \sum_{i=3}^{N-1} r_i b_i v_{i+1} \\
& + \sum_{i=4}^{N-1} \text{tr}(b_i a_i b_i) + \sum_{i=3}^{N-2} \text{tr}(b_i a_{i+1} b_i) + \sum_{i=1}^{N-3} h_i p_2 b_3 \dots b_{N-1-i} r_{N-i}
\end{aligned} \tag{3.114}$$

We can iterate. After k confinement, we get

$\mathcal{R}_k :$

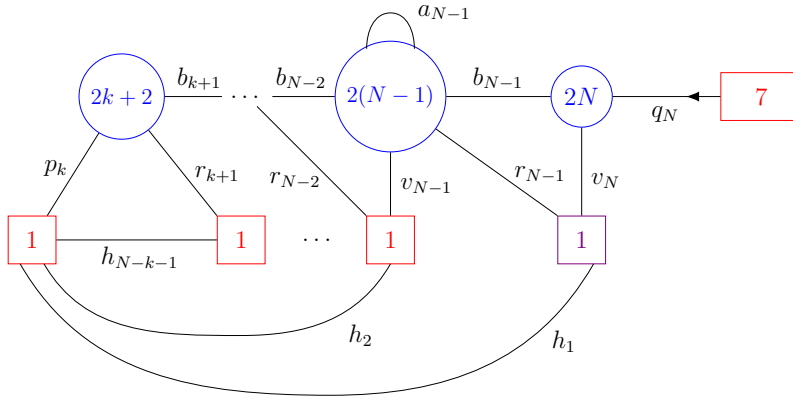

$$\begin{aligned}
\mathcal{W} = & \sum_{i=k+1}^{N-1} \text{Flip}[b_i b_i] + \sum_{j=1}^k \text{Flip}[(b_{k+1} b_{k+1})^{k+2-j} b_{k+2} \dots b_{N-1} q_N q_N b_{N-1} \dots b_{k+2}] \\
& + \sum_{i=k+1}^N \text{Flip}[b_i b_{i+1} \dots b_{N-1} q_N q_N b_{N-1} \dots b_{i+1} b_i] + \sum_{j=1}^{k+1} \text{Flip}[p_k (b_{k+1} b_{k+1})^{j-1} b_{k+1} \dots b_{N-1} q_N] \\
& + \sum_{i=k+2}^N \text{Flip}[v_i b_i b_{i+1} \dots b_{N-1} q_N] + \sum_{i=k+1}^{N-1} r_i b_i v_{i+1} + \sum_{i=k+2}^{N-1} \text{tr}(b_i a_i b_i) + \sum_{i=k+1}^{N-2} \text{tr}(b_i a_{i+1} b_i) \\
& + \sum_{i=1}^{N-k-1} h_i p_k b_{k+1} \dots b_{N-1-i} r_{N-i}
\end{aligned} \tag{3.115}$$

The mapping between two successive reconfinement is

$$\begin{array}{ccc}
\begin{array}{l}
R_{k-1} \\
\text{Flipper}[(b_k b_k)^{k-1-a} b_k \dots b_{N-1} q_N q_N b_{N-1} \dots b_k] \\
\text{Flipper}[b_{j+1} b_{j+2} \dots b_{N-1} q_N q_N b_{N-1} \dots b_{j+2} b_{j+1}] \\
\text{Flipper}[v_{N-j} b_{N-j} \dots b_{N-1} q_N] \\
\text{Flipper}[v_{k+1} b_{k+1} \dots b_{N-1} q_N] \\
\text{Flipper}[p_{k-1} (b_k b_k)^{N-1-a} b_k \dots b_{N-1} q_N] \\
h_i \\
h_{N-k} \\
\text{tr}(b_k b_k)^k \\
\vdots \\
\text{tr}(b_k b_k)^2
\end{array}
&
\iff
&
\begin{array}{l}
R_k \\
\text{Flipper}[(b_{k+1} b_{k+1})^{k-a} b_{k+1} \dots b_{N-1} q_N q_N b_{N-1} \dots b_{k+1}] \\
\text{Flipper}[b_{j+1} b_{j+2} \dots b_{N-1} q_N q_N b_{N-1} \dots b_{j+2} b_{j+1}] \\
\text{Flipper}[v_{N-j} b_{N-j} \dots b_{N-1} q_N] \\
\text{Flipper}[p_k (b_{k+1} b_{k+1})^{k-1} b_{k+1} \dots b_{N-1} q_N] \\
\text{Flipper}[p_k (b_{k+1} b_{k+1})^{N-1-a} b_{k+1} \dots b_{N-1} q_N] \\
h_i \\
\text{tr}(b_{k+1} b_{k+1})^{k+1} \\
\text{tr}(b_{k+1} b_{k+1})^k \\
\vdots \\
\text{tr}(b_{k+1} b_{k+1})^2
\end{array}
&
\begin{array}{l}
a = 0, \dots, k-1 \\
j = k, \dots, N-1 \\
j = 0, \dots, N-k-2 \\
a = N-k, \dots, N-1 \\
i = 1, \dots, N-k-1
\end{array}
\end{array}
\tag{3.116}$$

For $k = N - 2$, there won't be any antisymmetric field left. We get

\mathcal{R}_{N-2} :

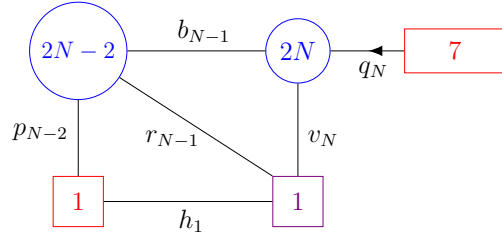

$$\begin{aligned}
\mathcal{W} &= \text{Flip}[b_{N-1} b_{N-1}] + \sum_{j=1}^{N-2} \text{Flip}[(b_{N-1} b_{N-1})^{N-j} q_N q_N] + \text{Flip}[b_{N-1} q_N q_N b_{N-1}; q_N q_N] \\
&+ \sum_{j=1}^{N-1} \text{Flip}[p_{N-2} (b_{N-1} b_{N-1})^{j-1} b_{N-1} q_N] + \text{Flip}[v_N q_N] + r_{N-1} b_{N-1} v_N + h_1 p_{N-2} r_{N-1}
\end{aligned}
\tag{3.117}$$

Now we can do the last confinement with the $Usp(2N - 2)$ group. It will produce the traceless antisymmetric field, B for $Usp(2N)$ (the trace part is killed by the flipper $\text{Flipper}[b_{N-1} b_{N-1}]$)

\mathcal{R}_{N-1} :

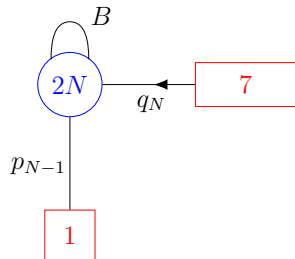

$$\begin{aligned}
\mathcal{W} &= \sum_{j=1}^N \text{Flip}[q_N B^{N-j} q_N] \\
&+ \sum_{j=1}^N \text{Flip}[p_{N-1} B^{j-1} q_N]
\end{aligned}$$

$$\tag{3.118}$$

The mapping for this last confinement is given by

$$\begin{array}{ccc}
\begin{array}{c}
R_{N-2} \\
\text{Flipper}[(b_{N-1}b_{N-1})^{N-2-a}b_{N-2}b_{N-1}q_N q_N b_{N-1}b_{N-2}] \\
\text{Flipper}[b_{N-1}q_N q_N b_{N-1}] \\
\text{Flipper}[q_N q_N] \\
\text{Flipper}[v_N q_N] \\
\text{Flipper}[p_{N-2}(b_{N-1}b_{N-1})^{N-1-a}b_{N-1}q_N] \\
h_1 \\
\text{tr}(b_{N-1}b_{N-1})^{N-1} \\
\text{tr}(b_{N-1}b_{N-1})^{N-2} \\
\vdots \\
\text{tr}(b_{N-1}b_{N-1})^2
\end{array}
&
\iff
&
\begin{array}{c}
R_{N-1} \\
\text{Flipper}[q_N B^{N-1-a} q_N] \\
\text{Flipper}[q_N B q_N] \\
\text{Flipper}[q_N q_N] \\
\text{Flipper}[p_{N-1} B^{N-2} q_N] \\
\text{Flipper}[p_{N-1} B^{N-1-a} b_{N-1} q_N] \\
\text{tr}(B^N) \\
\text{tr}(B^{N-1}) \\
\text{tr}(B^{N-2}) \\
\vdots \\
\text{tr}(B^2)
\end{array}
\end{array}
\quad a = 0, \dots, N-3$$

$$\begin{array}{c}
a = 1, \dots, N-1
\end{array}
\tag{3.119}$$

We can repackage the last frame into a manifestly $SU(8)$ invariant way to obtain the final frame

\mathcal{R}_{final} :

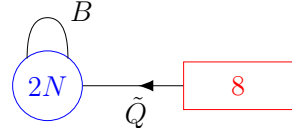

$$\mathcal{W} = \sum_{j=1}^N \text{Flip}[\tilde{Q} B^{N-j} \tilde{Q}]
\tag{3.120}$$

Where we define

$$\text{Flipper}[\tilde{Q} B^{N-j} \tilde{Q}] = \left(\begin{array}{ccc}
\overbrace{\text{Flipper}[q_N B^{N-j} q_N]}^7 & \vdots & \overbrace{\text{Flipper}[p_{N-1} B^{N-j} q_N]}^1 \\
\cdots & \vdots & \cdots \\
& \vdots & 0
\end{array} \right) \left. \begin{array}{l} \vphantom{\left(\right)} \right\} 7 \\ \vphantom{\left(\right)} \right\} 1
\end{array}
, \tag{3.121}$$

$$\tilde{Q} = \left(\begin{array}{ccc}
\overbrace{q_N}^7 & \vdots & \overbrace{p_{N-1}}^1
\end{array} \right)
\tag{3.122}$$

Now combining the mappings, we see that the confinement procedure gives

$$\begin{array}{ccc}
R_0 & & R_{final} \\
\text{Flipper}[b_{j+1} \dots b_{N-1} q_N q_N b_{N-1} \dots b_{j+1}] & \iff & \text{Flipper}[q_N B^{N-1-j} q_N] \quad j = 0, \dots, N-1 \\
\text{Flipper}[v_{N-j} b_{N-j} b_{N-j+1} \dots b_{N-1} q_N] & & \text{Flipper}[p_{N-1} B^{N-1-j} q_N] \quad j = 0, \dots, N-1 \\
h_i & & \text{tr}(B^{N+1-i}) \quad i = 1, \dots, N-1
\end{array}
\tag{3.123}$$

Now if we compare the original frame \mathcal{T}_0 and the last frame after confinement \mathcal{R}_{final} we see the self-duality and we obtain the following mapping

$$\begin{array}{ccc}
T_0 & & R_{final} \\
\text{tr}(Q A^j Q) & \iff & \text{Flipper}[q_N B^{N-1-j} q_N] \quad j = 0, \dots, N-1 \\
\text{tr}(Q A^j P) & & \text{Flipper}[q_N B^{N-1-j} p_{N-1}] \quad j = 0, \dots, N-1 \\
\text{tr}(A^i) & & \text{tr}(B^i) \quad i = 2, \dots, N
\end{array}
\tag{3.124}$$

Which is precisely the mapping proposed in [62].

3.5 Reduction to $3d \mathcal{N} = 2$ sequential deconfinement

It is possible to reduce $4d \mathcal{N} = 1$ theories on a circle, obtaining $3d \mathcal{N} = 2$ theories. Generically, this step introduces a superpotential term linear in the basic monopole operator (exceptions are, for instance, theories with 8 supercharges). Once in $3d$, it is possible to turn on real mass deformations, that do not exist in $4d$. Starting from a $4d USp(2N)$ gauge theory, $3d$ real masses allow to flow to $USp(2N)$ or $U(N)$ gauge groups with or without various types of monopole superpotentials. This process has been discussed in detail in the case without rank-2 matter [94], and for the case of $2F = 8$ [92, 93]. A brane interpretation has been found in [244]. Examples of $4d \mathcal{N} = 1$ symplectic quivers reduced and deformed to $3d \mathcal{N} = 2$ or $3d \mathcal{N} = 4$ unitary quivers have been discussed in [83, 111], mostly from the superconformal index perspective.

On the electric side, the story is as follows:

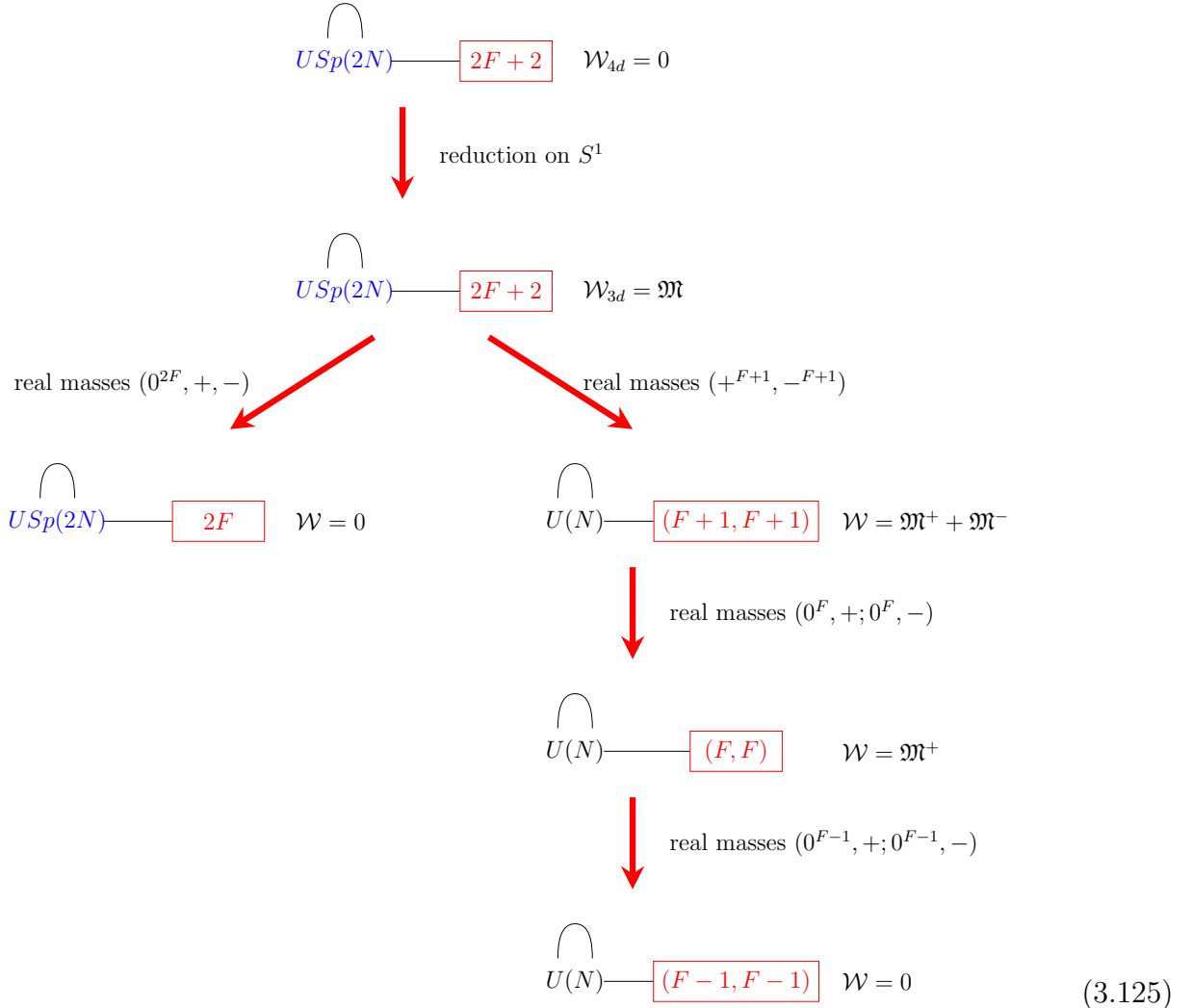

Where the rank-2 field is a traceless antisymmetric for $USp(2N)$ and a traceless adjoint for $U(N)$. The monopoles \mathfrak{M} , \mathfrak{M}^\pm are the monopoles with minimal GNO charges introduced in Section 2.1.2. See [94] for more details.

We could also turn on different real masses, possibly leading to non-zero Chern-Simons terms as in [85, 92, 93], but we refrain to do this in the present paper.

In the remaining of this section we perform the reduction and deformation of the fully deconfined dual, recovering the results found in [85] working in $3d$.

Reduction to the deconfined dual of $USp(2N)$ with antisymmetric and $2F + 2$ fundamentals, $\mathcal{W} = \mathfrak{M}$

We put the $4d$ duality on a circle. On the electric side we get $3d \mathcal{N} = 2 USp(2N)$ with antisymmetric and $(2F + 1)_Q + 1_P$ fundamentals, $\mathcal{W} = \mathfrak{M}$, with global symmetry $SU(2F + 2) \times U(1)$. On the magnetic side we obtain the same quiver as in $4d$, (3.107), with $F \rightarrow F + 1$. The difference is that the superpotential now includes N additional terms, linear in the monopole operators with GNO charges for a single gauge group, $\sum_{i=1}^N \mathfrak{M}^{0^{i-1}, \bullet, 0^{N-i}}$:

$$\begin{aligned}
\mathcal{W} = & \sum_{i=1}^{N-1} \text{Flip}[b_i b_i] + \sum_{i=1}^N m_i \text{tr}(b_i b_{i+1} \dots b_{N-1} q_N q_N b_{N-1} \dots b_{i+1} b_i) + \sum_{i=1}^N l_i v_i b_i b_{i+1} \dots b_{N-1} q_N \\
& + \sum_{i=1}^{N-1} r_i b_i v_{i+1} + \sum_{i=1}^{N-1} \text{tr}(b_i a_i b_i) + \sum_{i=1}^{N-2} \text{tr}(b_i a_{i+1} b_i) + \sum_{i=1}^{N-1} h_i v_i b_1 \dots b_{N-1-i} r_{N-i} \\
& + \sum_{i=1}^N \mathfrak{M}^{0^{i-1}, \bullet, 0^{N-i}}
\end{aligned} \tag{3.126}$$

One remark about notation. In this section, we have given an explicit name to the flippers. Concretely in (3.126) we have used $\text{Flipper}[b_i b_{i+1} \dots b_{N-1} q_N q_N b_{N-1} \dots b_{i+1} b_i] \rightarrow m_i$ and $\text{Flipper}[v_i b_i b_{i+1} \dots b_{N-1} q_N] \rightarrow l_i$.

For convenience we reproduce also the mapping of the chiral ring generators:

$$\begin{aligned}
\text{tr}(Q A^i Q) & \iff m_{i+1} & i = 0, \dots, N-1 \\
\text{tr}(Q A^j P) & \iff l_{N-j} & j = 0, \dots, N-1 \\
\text{tr}(A^k) & \iff h_{N+1-k} & k = 2, \dots, N
\end{aligned} \tag{3.127}$$

This is the same mapping as in $4d$, at this level there are no monopoles in the chiral ring, due to the presence of linear monopole terms in the superpotential.

Flow to the deconfined dual of $USp(2N)$ with antisymmetric and $2F$ fundamentals, $\mathcal{W} = 0$

We now discuss what happens on the fully deconfined quiver 3.126 upon turning on real masses. We first turn on a real mass of the form $(0^{2F}, +, -)$ (that is we are moving to the left in

the diagram 3.125), on the electric side Q_{2F+1} and P become massive. Notice that the rank of the global symmetry decrease by one unit. Accordingly the mesons $\text{tr}(Q_I A^i Q_{2F+1})$ and $\text{tr}(Q_I A^i P)$ have non-zero real mass, for $I = 1, \dots, 2F$. Notice that $\text{tr}(Q_{2F+1} A^i P)$ has zero total real mass. The electric theory becomes $3d \mathcal{N} = 2 \text{USp}(2N)$ with antisymmetric and $2F$ fundamentals, $\mathcal{W} = 0$, with global symmetry $SU(2F) \times U(1) \times U(1)$.

It follows from the mapping 3.127 that the singlets $(l_i)_I$ and $(m_i)_{I,2F+1}$ become massive for $I = 1, \dots, 2F$, while $(l_i)_{2F+1}$ remain massless. The l_j 's and $(m_i)_{I,2F+1}$'s become massive imply that also the elementary gauge variant fields v_i, r_i and $(q_N)_{2F+1}$ become massive. In other words the saw structure in the fully deconfined quiver disappears, and we are left with

$$\begin{aligned}
\mathcal{W} = & \sum_{i=1}^{N-1} \text{Flip}[b_i b_i] + \sum_{i=1}^N m_i \text{tr}(b_i b_{i+1} \dots b_{N-1} q q b_{N-1} \dots b_i b_{i+1}) + \sum_{i=1}^{N-1} \text{tr}(b_i a_i b_i) \\
& + \sum_{i=1}^{N-2} \text{tr}(b_i a_{i+1} b_i) + \sum_{i=1}^{N-1} h_i \mathfrak{M}^{\bullet, N-i, 0^i} + \sum_{i=1}^N (l_i)_{2F+1} \mathfrak{M}^{0^{i-1}, \bullet, N-i+1}
\end{aligned} \tag{3.128}$$

Notice that the linear monopole superpotential $\sum_{i=1}^N \mathfrak{M}^{0^{i-1}, \bullet, 0^{N-i}}$ is lifted, while the massless gauge singlets h_i and $(l_i)_{2F+1}$ now flip monopole operators. (this is similar to the dimensional reduction of Seiberg and IP dualities [103]). These interactions are generated dynamically, one way to understand them is that such interactions are allowed by all global symmetries, and if they are not generated the gauge singlets would be free fields, which cannot be correct.

Equation (3.128) agrees with the results of section 2.4 of [85] (modulo renaming $h_i \rightarrow \gamma_i$ and $(l_i)_{2F+1} \rightarrow \sigma_i$), obtained by sequentially deconfining in $3d$, using the deconfining duality $\text{antisymm}_{2N \times 2N} \leftrightarrow \text{USp}(2N-2) - [2N], \mathcal{W} = \gamma \mathfrak{M}$. The only difference is the precise extended monopole flipped by h_i , the subtlety related to the degenerate holomorphic operators which can in principle be flipped by h_i was not appreciated in [85]. One can check that with the superpotential above, setting $F = 3$, the tail reconfines appropriately and it is possible to derive the self-duality modulo flips of $3d \mathcal{N} = 2 \text{USp}(2N)$ with antisymmetric and 6 fundamentals, $\mathcal{W} = 0$, at each step one h_i singlet is eaten, while the extended monopoles flipped by $(l_i)_{2F+1}$ 'shorten' according to the rules of [245].

Flow to the deconfined dual of $U(N)$ with adjoint and $F + 1$ flavors, $\mathcal{W} = \mathfrak{M}^+ + \mathfrak{M}^-$

We now start from the $3d$ duality $\text{USp}(2N)$ with $2F + 2$, $\mathcal{W} = \mathfrak{M} \leftrightarrow 3.126$, and turn on a real mass of the form $(+^{F+1}, -^{F+1})$ (that is we are moving to the right in the diagram 3.125). This type of real mass induces a Higgsing of the form $\text{USp}(2N_i) \rightarrow U(N_i)$ on both sides of the duality, the antisymmetric fields are replaced by adjoints and a pair of fundamentals is replaced by a fundamental plus an antifundamental. The Higgsing is induced by a vev of 'Coulomb branch type', that is, on both sides of the duality, we are going to a specific sublocus of the moduli space of vacua (inside the so called $\mathcal{N} = 2$ Coulomb branch) where there is the

maximum amount of massless fields. Moreover, the monopole superpotentials \mathfrak{M} 's are replaced by $(\mathfrak{M}^+ + \mathfrak{M}^-)$'s. See [83, 94, 111] for more details.

On the electric side we flow to $U(N)$ with adjoint and $(F_Q + 1_P, (F + 1)_{\tilde{Q}})$ flavors and $\mathcal{W} = \mathfrak{M}^+ + \mathfrak{M}^-$, with global symmetry $SU(F + 1) \times SU(F + 1) \times U(1)^{13}$. The rank of the global symmetry decreases by one unit, as it should.

On the magnetic side, we end up with a fully deconfined quiver

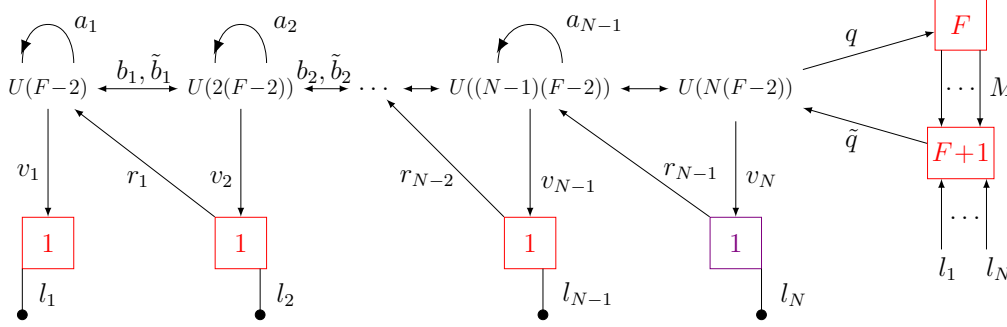

$$\mathcal{W} = \sum_{i=1}^{N-1} \text{Flip}[b_i \tilde{b}_i] + \sum_{i=1}^N M_i \text{tr}(b_i b_{i+1} \dots b_{N-1} q \tilde{q} \tilde{b}_{N-1} \dots \tilde{b}_i \tilde{b}_{i+1})$$

$$+ \sum_{i=1}^N l_i \text{tr}(\tilde{q} \tilde{b}_{N-1} \dots \tilde{b}_{i+1} \tilde{b}_i v_i) + \sum_{i=1}^{N-1} \text{tr}(r_i b_i v_{i+1}) + \sum_{i=1}^{N-1} \text{tr}(b_i a_i \tilde{b}_i) + \sum_{i=1}^{N-2} \text{tr}(b_i a_{i+1} \tilde{b}_i)$$

$$+ \sum_{i=1}^{N-1} h_i \text{tr}(r_{N-i} \tilde{b}_{N-1-i} \dots \tilde{b}_1 v_1) + \sum_{i=1}^N (\mathfrak{M}^{0^{i-1}, +, 0^{N-i}} + \mathfrak{M}^{0^{i-1}, -, 0^{N-i}})$$
(3.129)

Where we did not draw the h_i singlets¹⁴. The global symmetry of (3.129) is $SU(F + 1) \times SU(F) \times U(1) \times U(1)$.

The mapping is¹⁵

$$\begin{aligned} \text{tr}(\tilde{Q}_I A^i Q^J) & \iff (M_{i+1})_I^J & i = 0, \dots, N-1 \\ \text{tr}(\tilde{Q}_I A^i P) & \iff (l_{N-i})_I & i = 0, \dots, N-1 \\ \text{tr}(A^k) & \iff h_{N+1-k} & k = 2, \dots, N \end{aligned} \quad (3.130)$$

In the special case $F = 3$, we can use the confining duality for $U(N)$ with $(N + 2, N + 2)$ flavors and $\mathcal{W} = \mathfrak{M}^- + \mathfrak{M}^+$ [94] and reconfine the tail in 3.129, deriving the self-duality modulo flips of $3d \mathcal{N} = 2 U(N)$ with adjoint and $(4, 4)$ fundamentals, $\mathcal{W} = \mathfrak{M}^+ + \mathfrak{M}^-$, discussed in [92].

Flow to the deconfined dual of $U(N)$ with adjoint and F flavors, $\mathcal{W} = \mathfrak{M}^+$

We now turn on real masses $(0^F, +; 0^F, -)$ in the previous duality.

On the electric side one monopole superpotential is lifted and we flow to $U(N)$ with adjoint and $(F_Q, F_{\tilde{Q}})$ flavors and $\mathcal{W} = \mathfrak{M}^+$, with global symmetry $SU(F) \times SU(F) \times U(1) \times U(1)$. The rank of the global symmetry decreases by one unit, as expected.

¹³We split the global symmetry artificially into $SU(F + 1)_{\tilde{Q}} \times SU(F)_Q \times U(1)_P \times U(1)_A$ to match the visible symmetries in the magnetic side.

¹⁴The double arrows $U(N_1) \leftrightarrow U(N_2)$ stand for a pair of bifundamentals with opposite orientation.

¹⁵We have checked that the mapping is consistent by computing the R-charges of the operators (as a function of two variables corresponding to the two $U(1)$ symmetries) on both sides.

On the magnetic side, using 3.130, the singlets $(l_j)_I$ and $(M_i)_{F+1}^J$ become massive. This in turn implies that \tilde{q}_{F+1} gets a mass, together with the v_i 's and the r_i 's. Hence the saw disappears and we end up with

$$\begin{aligned}
\mathcal{W} = & \sum_{i=1}^{N-1} \text{Flip}[b_i \tilde{b}_i] + \sum_{i=1}^N M_i \text{tr}(b_i b_{i+1} \dots b_{N-1} q \tilde{q} \tilde{b}_{N-1} \dots \tilde{b}_i \tilde{b}_{i+1}) + \sum_{i=1}^{N-1} \text{tr}(b_i a_i \tilde{b}_i) \\
& + \sum_{i=1}^{N-2} \text{tr}(b_i a_{i+1} \tilde{b}_i) + \sum_{i=1}^N (l_i)_{2F+1} \mathfrak{M}^{0^{i-1}, +^{N-i+1}} + \sum_{i=1}^{N-1} h_i \mathfrak{M}^{+, N-i, 0^i} + \sum_{i=1}^N \mathfrak{M}^{0^{i-1}, -, 0^{N-i}}
\end{aligned} \tag{3.131}$$

Notice that half of the linear monopole superpotential disappeared and that the massless gauge singlets $(l_i)_F$ and h_i now flip monopole operators instead of mesons constructed with the saw.

In the special case $F = 3$, we can use the confining duality for $U(N)$ with $(N+1, N+1)$ flavors and $\mathcal{W} = \mathfrak{M}^- + h\mathfrak{M}^+$ [94] to reconfine the tail in 3.131, deriving the self-duality modulo flips of $3d \mathcal{N} = 2 U(N)$ with adjoint and $(3, 3)$ fundamentals, $\mathcal{W} = \mathfrak{M}^+$ [92].

Flow to the deconfined dual of $U(N)$ with adjoint and $F-1$ flavors, $\mathcal{W} = 0$

We now turn on real masses $(0^{F-1}, +; 0^{F-1}, -)$ in the previous duality.

On the electric side one monopole superpotential is lifted and we flow to $U(N)$ with adjoint and $F-1, F-1$ flavors and $\mathcal{W} = 0$, with global symmetry $SU(F-1) \times SU(F-1) \times U(1)^3$. Again, the rank of the global symmetry decreases by one unit.

On the magnetic side,

$$\begin{aligned}
\mathcal{W} = & \sum_{i=1}^{N-1} \text{Flip}[b_i \tilde{b}_i] + \sum_{i=1}^N M_i \text{tr}(b_i b_{i+1} \dots b_{N-1} q \tilde{q} \tilde{b}_{N-1} \dots \tilde{b}_i \tilde{b}_{i+1}) + \sum_{i=1}^{N-1} \text{tr}(b_i a_i \tilde{b}_i) \\
& + \sum_{i=1}^{N-2} \text{tr}(b_i a_{i+1} \tilde{b}_i) + \sum_{i=1}^N \left((l_i)_{2F+1} \mathfrak{M}^{0^{i-1}, +^{N-i+1}} + (M_i)_{F,F} \mathfrak{M}^{0^{i-1}, -^{N-i+1}} \right) \\
& + \sum_{i=1}^{N-1} h_i \mathfrak{M}^{+, i, 0^{N-i}} + \sum_{i=1}^{N-1} \mathfrak{M}^{0^{i-1}, -, 0^{N-i}}
\end{aligned} \tag{3.132}$$

The result 3.132 agrees with section 3.2 of [85] (modulo renaming $h_i \rightarrow \gamma_i$, $(l_i)_{2F+1} \rightarrow \sigma_i^+$, $(M_i)_{F,F} \rightarrow \sigma_i^-$ and $F \rightarrow F+1$). Also here, the difference is the precise extended monopole flipped by h_i , the subtlety related to the degenerate holomorphic operators which can in principle be flipped by h_i was not appreciated in [85]. In the special case $F = 3$, we can use the confining duality for $U(N)$ with $(N+1, N+1)$ flavors and $\mathcal{W} = \mathfrak{M}^- + h\mathfrak{M}^+$ to reconfine the

tail in 3.132 and derive the self-duality modulo flips of $3d \mathcal{N} = 2 U(N)$ with adjoint and $(2, 2)$ fundamentals, $\mathcal{W} = 0$, discussed in [92].¹⁶

3.6 Outlook

In this chapter we have shown that all $4d \mathcal{N} = 1$ S-confining gauge theories with a single gauge group, vanishing tree-level superpotential and rank-1 and/or rank-2 matter can be obtained from the basic Seiberg (2.87) and Intriligator-Pouliot (2.88) S-confining dualities. We have also obtained the confining superpotential in a closed form for all theories. We did this using new versions of the deconfinement technique of [60]. Then we have work out the sequential deconfinement of the $4d \mathcal{N} = 1 USp(2N)$ with antisymmetric and $2F$ fundamentals gauge theory. As an application we gave a proof of the self-dual modulo flips of this theory for the special case $F = 4$. Our result participates to the project of reducing the number of apparently independent dualities. We finished by studying the dimensional reduction to $3d$ of this fully deconfined frame. We recovered previously known $3d$ dualities and found new ones.

There are other directions to explore. An obvious one is trying to go beyond the classification of [46] by considering more than one node quivers and/or non-vanishing tree-level superpotential [246]. There are also S-confining theories involving non-quivers type of matter as rank-3 and *Spin* gauge theories with chirals in the spinor representation [46]. It would be really interesting if we can also obtain these theories from simpler dualities. It would also be worth exploring beyond S-confining theories. For example, more general IR dualities involving rank-2 matter [53, 55, 56, 61].

We can also try to prove the *USp* version of the Kutasov-Schwimmer type duality, recalled in Section 2.6.2, using our sequentially deconfined dual of *USp*($2N$) with an antisymmetric and $2F$ fundamentals. Namely one can turn on a superpotential term $tr(A^j)$ on the electric side, such term maps to a singlet on the magnetic, so a Higgsing process is induced. The study of this Higgsing might shed light on the dualities of [53–55, 247]. We expect the *degenerate holomorphic operator ambiguity* encountered in this paper to play an important role. It would also be interesting to study *degenerate holomorphic operator ambiguity* in other examples, possibly involving different kinds of gauge groups.

There are quite a few *self-dualities modulo flips* proposed in the literature [62, 64, 65, 197, 198], such as $SU(2N)$ with antisymmetric, conjugate antisymmetric and $(4, 4)$ fundamentals, or $SU(6)$ with 2 antisymmetrics and $(2, 6)$ fundamentals, or $SU(8)$ with 2 antisymmetrics and $(0, 8)$ fundamentals. A natural question is if such self-dualities can be proven using only the basic Seiberg and Intriligator-Pouliot dualities, as done in this chapter for *USp*($2N$) with antisymmetric and 8 fundamentals. Notice that many self-dual gauge theories have been con-

¹⁶At each reconfining step, one linear monopole term disappears, one h_i is eaten, while the $(M_i)_I^J$'s ($I, J = 1, 2$) and the two towers $(l_i)_{2F+1}$ and $(M_i)_{F,F}$ survive. The self-duality reads

$$U(N) + \Phi + (2_{\bar{Q}}, 2_{\bar{Q}}), \mathcal{W} = 0. \Leftrightarrow U(N) + \phi + (2_q, 2_{\bar{q}}), \mathcal{W} = \sum_i \left(M_i tr(\tilde{q}\phi^i q) + (l_i)_{2F+1} \mathfrak{M}_{\phi^i}^+ + (M_i)_{F,F} \mathfrak{M}_{\phi^i}^- \right). \quad (3.133)$$

structured simply 'adding one flavor' to an S-confining gauge theory [65, 197], so the fact that the S-confining dualities can be proven is encouraging.

Related to the above point, many S-confinements and many self-dualities have been proposed for $4d \mathcal{N} = 1$ $Spin(N)$ theories with spinors and vectors [65, 197, 198, 200]. It would be very interesting to find a way to deconfine spinorial matter and try to prove such proposals.

S-confinements for $3d \mathcal{N} = 2$ theories with SO/Usp gauge groups and adjoint matter were recently proposed in [87], and [98] pointed out a relation to $4d \mathcal{N} = 1$ S-confinements for Usp gauge group and antisymmetric matter. It might be interesting to deform the $4d \mathcal{N} = 1$ sequential deconfinements as in [98]. See [243] for the sequential deconfinement of $3d \mathcal{N} = 2$ rank-2 matter with SO/USp gauge groups.

Chapter 4

$4d \mathcal{N} = 1$ dualities from $5d$ dualities

The content of this Chapter is essentially taken from [3].

4.1 Introduction

In this Chapter, we are interested in $5d$ quiver gauge theories whose UV completion is actually a $6d$ SCFT. These are the KK-theories evocated in the introduction chapter. In many instances, there are more than one $5d$ gauge theories with the same infinite coupling SCFT ($5d$ or $6d$). This phenomenon goes under the name of $5d$ dualities. The physical picture is really that the UV SCFT can be relevantly deformed in various different ways, triggering RG flows to different IR gauge theories. The main point of this Chapter is to give a recipe to construct $4d \mathcal{N} = 1$ dualities from $5d$ KK dualities and test this prescription on concrete examples.

Prescription

Starting from a $5d$ KK quiver with 8 supercharges, the $4d$ quivers has the same gauge structure (but in $4d$ the nodes are $\mathcal{N} = 1$ 4 supercharges nodes), the same matter fields (but in $4d$ there are chiral multiplets instead of hyper multiplets) plus for each bifundamental we add a "triangle". A "triangle" means that if in $5d$ there is a bifundamental hyper connecting node A with node B , in $4d$ there is a chiral bifundamental going from node A to node B , a fundamental going from node B to a global $SU(2)$ node, and a fundamental going from the global $SU(2)$ node to node A . We also add a cubic $SU(2)$ invariant superpotential term. See eq. 4.1. Such triangles are meant to reproduce the $5d$ axial symmetries (which are anomalous in $4d$ but not in $5d$) and the $5d$ instantonic symmetries (which do not exist in $4d$). With this prescription we are able to associate a $4d$ quiver to $5d$ quivers, in such a way that the rank of the global $4d$ symmetry is equal to the rank of the global $5d$ symmetry minus 2. We only consider quivers such that this prescription yields a $4d$ quivers without gauge anomalies. The previous prescription is illustrated by the following example, where round red nodes are SU gauge groups¹

¹In the second quiver of (4.1) we didn't respected our color code, evocated in the introduction chapter, for all the SU flavor nodes. We did so to more easily distinguish which symmetry we are talking about in what follows. We precise here that in this quiver all the flavor nodes are of the SU type.

$$5d: \quad \boxed{N+2} - \textcircled{N} - \textcircled{N} - \textcircled{N} - \boxed{N+2} \quad \Downarrow \quad (4.1)$$

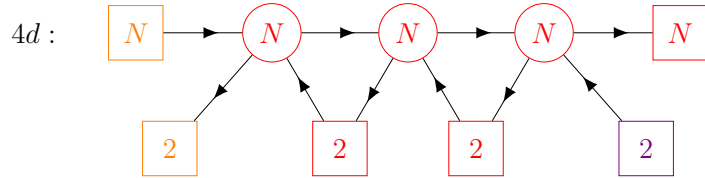

$$\mathcal{W} = 2 \text{ Triangles} + \text{Flips}$$

One remark about the prescription is that when we go from a hyper in $5d$ to a chiral in $4d$ we are free to choose it in the fundamental or anti-fundamental representation of the gauge group. The constraint on gauge anomaly cancellation fixes the choice of the representation. In the example that we show the $N+2$ hypers on the left in $5d$ have been split in N fundamentals and 2 anti-fundamentals. Another remark is that the $4d$ dualities involve flipping fields. They play a crucial role in the validity of the dualities.

The main point of this chapter is that starting from two $5d$ dual KK quivers, hence with the same $6d$ SCFT UV completion, the two $4d$ quivers constructed with the above prescription are infrared dual.

This chapter is organized as follows.

In section 4.2, we present the first class of theories call $R_{N,k}$. We are able to prove the new $4d$ $\mathcal{N} = 1$ dualities that we get in the same spirit of the last chapter.

In section 4.3, we study the second class of theories, $A_{n,m}$. For the new dualities that we derive we do not have a proof. The proposed dualities are tested by matching the t'Hooft anomalies and the central charges.

In section 4.4, we discuss a set of theories obtaining by Higgsing the class $R_{N,k}$.

In section 4.5, we give an outlook.

4.2 First class: rectangular pq-webs, the $R_{N,k}$ theories

4.2.1 A simple class: $R_{N,2}$ and its two duals

In this subsection we consider a simple class of theories, which are special cases of the more general class studied in the next subsection 4.2.2.

5d triality

The first 5d dualities that we are studying combine into a triality:

$$\begin{array}{ccc}
 \star_1) & \star_2) & \star_3) \\
 \textcircled{N} \text{---} \boxed{2N+4} & \textcircled{2N-2} \text{---} \boxed{2N+4} & \boxed{4} \text{---} \underbrace{\textcircled{2} \cdots \textcircled{2}}_{N-1} \text{---} \boxed{4}
 \end{array} \tag{4.2}$$

To understand why the three theories in (4.2) are dual to each other, we recall the analysis done in [189–191]. We start from the 6d Type IIA brane setup Figure 4.4. Then, we do a circle compactification and perform T-duality along the compactified direction. We obtain a Type IIB brane setup. The $O8^-$ plane becomes two $O7^-$ planes and the $D8$ become $D7$. The resulting brane web, for $N = 3$, is shown on the left in Figure 4.1. Then in order to read the gauge theory we have to resolve the $O7^-$ plane by 7-branes [248]. We have the choice to resolve the two $O7^-$ or just one. If we resolve the two $O7^-$ we get the brane web in the middle of Figure 4.1. After pulling-out the 7-branes we obtain the $SU(3)$ gauge theory with 10 fundamental hypers shown in the right of Figure 4.1. The general N case corresponds to the left theory in (4.2) and we call it $R_{N,2}$. This name will be clear when we consider the generalization in the next subsection.

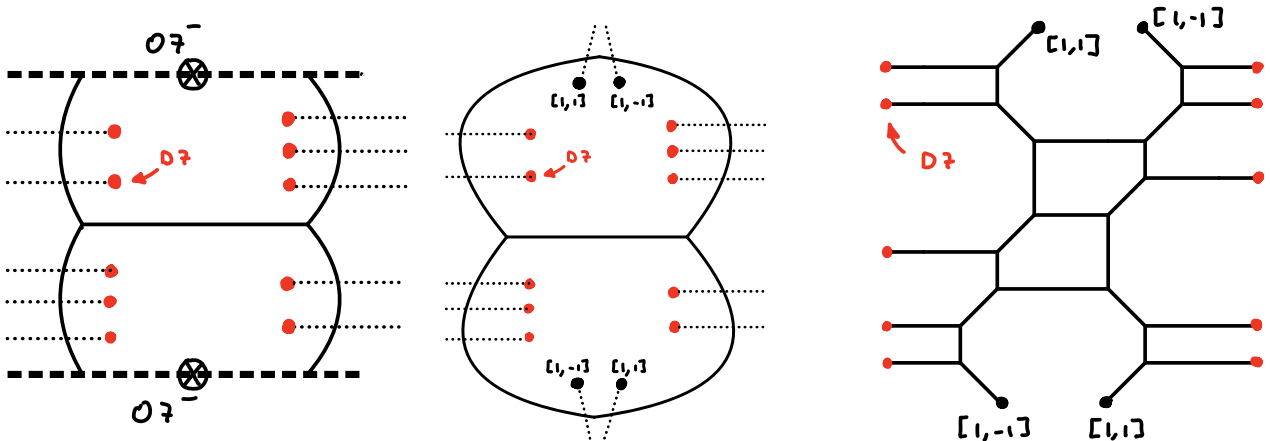

Figure 4.1: Resolution of the two $O7^-$ planes leading to $R_{3,2}$: a $SU(3)$ gauge theory with 10 fundamental.

Now, if we resolve only one $O7^-$ plane we obtain, after pulling out the 7-branes, the $USp(4)$ gauge theory on the right of Figure 4.2. It corresponds to the middle theory in (4.2).

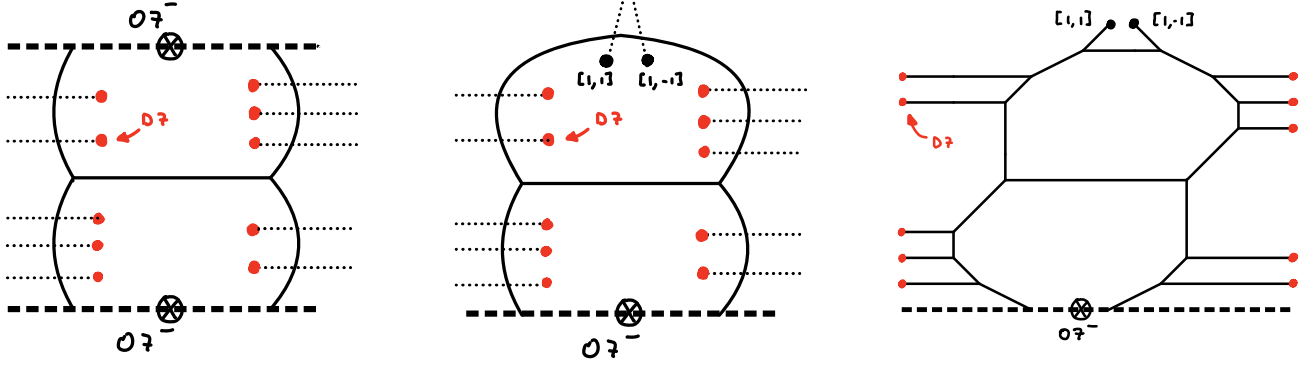

Figure 4.2: Resolution of one of the two $O7^-$ planes leading to the $USp(4)$ with 10 fundamental hypers gauge theory.

If we perform an S-duality on the right figure of Figure 4.1 (which amounts to a 90° rotation of the pq-web), we obtain Figure 4.3 which describes $4F + SU(2) - SU(2) + 4F^2$ quiver theory. It corresponds to the right theory in (4.2).

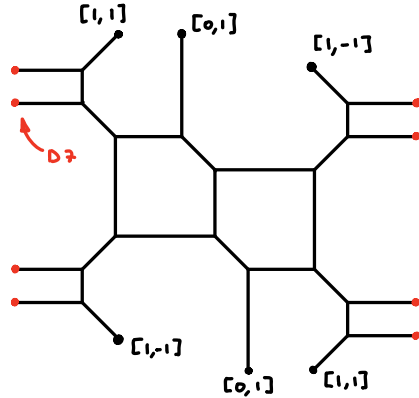

Figure 4.3: $4F + SU(2) - SU(2) + 4F$

Since the theories in (4.2) are either coming from the same brane system or are related by S-duality, it is clear that they are UV dual in the sense of completed by the same theory.

6d UV completion: (D_{N+2}, D_{N+2}) Minimal Conformal Matter

The 6d UV completion of the 5d theories in (4.2) is given by the following Type IIA brane setup [189–191]:

²The notation means that the first and the second $SU(2)$ are coupled to 4 fundamental hypers and the horizontal bar represents a bifundamental hyper between the two gauge nodes.

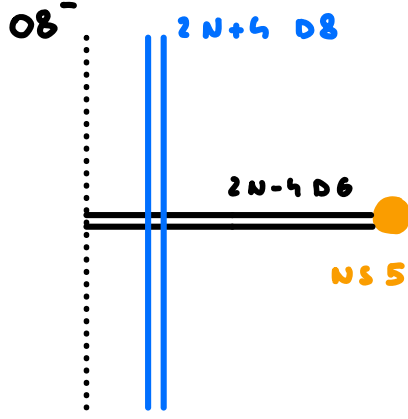

Figure 4.4: Type IIA brane setup corresponding to the $6d$ UV completion of $R_{N,2}$.

This theory is called the (D_{N+2}, D_{N+2}) Minimal Conformal Matter. On the tensor branch, the system flows to the following gauge theory:

$$\begin{array}{c}
 \textcircled{2N-4} \text{---} \text{[} 2N+4 \text{]} \\
 \end{array} \tag{4.3}$$

4d triality

We can now apply our prescription described in section 4.1. Starting from the left theory in (4.2), we replace the hypers in $5d$ by a chiral field in $4d$. We also have to split the $2N+4$ hypers into $N+2$ chirals and $N+2$ anti-chirals for the theory to be non-anomalous. We get the theory \star_1) in (4.4). We have also added a gauge singlet in the bifundamental of the $SU(N+2)_Q \times SU(N+2)_{\tilde{Q}}$ flavor symmetry and a flipping type superpotential. The role of this flipper is essential for the duality to be true as we will see in the following. Our procedure applied to the theory in the middle of (4.2) produces the theory \star_2) in (4.4). Finally, we focus to the right theory of (4.2). In this case, since we have a quiver in $5d$ our procedure tells us that for each bifundamental we have to associate a “triangle” with an explicit $SU(2)$ symmetry. We obtain the following $4d$ quiver \star_3) in (4.5) with the correct set of flippers.

$$\begin{array}{ccc}
 \star_1) & \longleftrightarrow & \star_2) \\
 \begin{array}{c}
 \textcircled{N} \\
 \swarrow \quad \searrow \\
 Q \quad \tilde{Q} \\
 \swarrow \quad \searrow \\
 \text{[} N+2 \text{]} \quad \text{[} N+2 \text{]} \\
 \mathcal{W} = \text{Flip}[Q\tilde{Q}]
 \end{array} & & \begin{array}{c}
 \textcircled{2N-2} \text{---}^Q \text{[} 2N+4 \text{]} \\
 \mathcal{W} = \text{Flip}[Q\tilde{Q}]
 \end{array}
 \end{array} \tag{4.4}$$

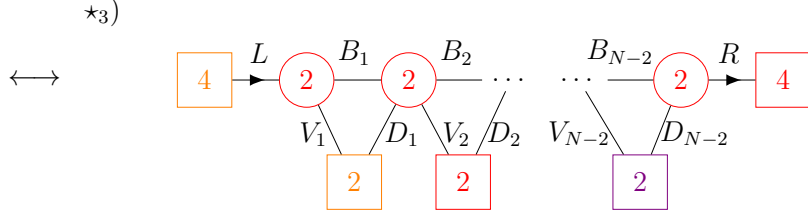

$$\mathcal{W} = (N - 2) \text{ Triangles} + \text{Flip}[L L] + \text{Flip}[R R] + \sum_{i=1}^{N-2} \text{Flip}[B_i B_i] \quad (4.5)$$

The mapping of the chiral ring generators between the different frames is

$$\begin{array}{ccc} \star_1) & & \star_2) & & \star_3) \\ \left\{ \begin{array}{l} \text{Flipper}[Q \tilde{Q}] \\ Q^N \\ \tilde{Q}^N \end{array} \right. & \iff & \text{Flipper}[Q Q] & \iff & \left\{ \begin{array}{l} \text{Flipper}[L L] \\ \text{Flipper}[R R] \\ L B_1 \dots B_{N-2} R \\ L B_1 \dots B_i V_{i+1} & i = 0, \dots, N - 3 \\ D_j B_{j+1} \dots B_{N-2} R & j = 1, \dots, N - 2 \\ \text{Flipper}[B_k B_k] & k = 1, \dots, N - 2 \\ D_i B_{i+1} \dots B_j V_j & i = 1, \dots, N - 3 \text{ \& } \\ & j = i + 1, \dots, N - 2 \end{array} \right. \end{array} \quad (4.6)$$

We have to understand the mapping (4.6) in the following way. In the UV, the manifest global symmetries in $\star_1)$, $\star_2)$ and $\star_3)$ are different. In the IR, there is the emergence of the global symmetry. Therefore some operators in the UV will combined into an operator transforming into the bigger symmetry group. In our case the global symmetry group³ in the IR is $SU(2N + 4)$. Then we claim that in the frame $\star_1)$ the three operators $\text{Flipper}[Q \tilde{Q}]$, Q^N and \tilde{Q}^N will combine into an operator that transforms into an antisymmetric representation of the emergent $SU(2N + 4)$ global symmetry group. One necessary condition to make sense is that the number of degrees of freedom (d.o.f) corresponds to the dimension of the representation. In this case $\text{Flipper}[Q \tilde{Q}]$ contains $N^2 + 4N + 4$ d.o.f, Q^N and \tilde{Q}^N $\frac{1}{2}(N + 2)(N + 1)$ each. The sum equals to $2N^2 + 7N + 6$ which indeed correspond to the dimension of the antisymmetric representation of $SU(2N + 4)$. The same kind of counting works for the frame $\star_3)$.

Proof of the 4d dualities

In this subsection, we provide a “proof” of the 4d triality (4.4)-(4.5). By “proof”, we mean the use of a sequence of well-established dualities as in Chapter 3. Starting from $\star_1)$ and apply the Seiberg duality (2.85), we obtain

$$\begin{array}{c} \textcircled{2} \text{ --- } \boxed{2N + 4} \quad \mathcal{W} = 0 \end{array} \quad (4.7)$$

We see that the role of the flipper in $\star_1)$ in (4.4) is to give a mass to the singlet present in the Seiberg duality and therefore get $\mathcal{W} = 0$ in (4.7).

³We don't pay attention to the global structure of the global symmetry.

Now starting from \star_2) in (4.4) and applying the IP duality (2.86), we once again get (4.7). This implies that also \star_1) and \star_2) are dual.

More work has to be done in order to prove that also \star_3) is dual. It goes as follows. We first apply the CSST duality (2.95) to the left $SU(2)$. The form of this duality that is useful for our purpose is the following

The important effect of this duality is to give a mass to the field D_1 in (4.5). Indeed, we are left with

Now we realize that the second $SU(2)$ is coupled to 6 chirals and therefore we can use the IP confinement (2.88) for this $SU(2)$. The form useful of this confinement is the following

After the confinement of the second $SU(2)$ we can see that the next one on the right is also coupled to 6 chirals and therefore we can iterate the use of (4.10). We can do $(N - 4)$ more s-confining (4.10). We get

The last $SU(2)$ is once again coupled to 6 chirals and therefore we can use for the last time the

confinement (2.88). We end up with

$$\begin{array}{ccc}
 \begin{array}{c}
 \boxed{4} \xrightarrow{l} \textcircled{2} \xrightarrow{r} \boxed{4} \\
 \textcircled{2} \xrightarrow{v_1} \textcircled{2} \xrightarrow{v_2} \cdots \xrightarrow{v_{N-2}} \textcircled{2} \\
 \mathcal{W} = 0
 \end{array}
 & \equiv &
 \begin{array}{c}
 \textcircled{2} \xrightarrow{p} \boxed{2N+4} \\
 \mathcal{W} = 0
 \end{array}
 \end{array}
 \quad (4.12)$$

To summarize, starting from \star_3) in (4.5) and doing the CSST duality followed by $(N - 2)$ s-confining duality we get (4.7) which proves the $4d$ triality (4.4)-(4.5).

Notice that the duality between \star_3) and (4.12) is one of the simplest instances of the $4d$ mirror symmetry of [48, 49, 82], and it uplifts the $3d$ mirror symmetry between $U(1)$ with N flavors and the linear Abelian quiver $U(1)^{N-1}$.

Now using the proof we can justify the mapping (4.6). Indeed we can obtain the mapping from the frame (4.5) to the frame (4.12) by following the mapping of the basic dualities (CSST and the IP confinement). We get

$$\begin{array}{ccc}
 \begin{array}{c}
 (4.5) \\
 \left\{ \begin{array}{l}
 \text{Flipper}[L L] \\
 \text{Flipper}[R R] \\
 LB_1 \dots B_{N-2} R \\
 LB_1 \dots B_i V_{i+1} \\
 D_j B_{j+1} \dots B_{N-2} R \\
 \text{Flipper}[B_k B_k] \\
 D_i B_{i+1} \dots B_j V_j
 \end{array} \right.
 \end{array}
 & \iff &
 \begin{array}{c}
 (4.12) \\
 \left\{ \begin{array}{l}
 ll \\
 rr \\
 lr \\
 l v_{i+1} \quad i = 0, \dots, N-3 \\
 r v_j \quad j = 1, \dots, N-2 \\
 v_k^2 \quad k = 1, \dots, N-2 \\
 v_i v_j \quad i = 1, \dots, N-3 \& \\
 \quad j = i+1, \dots, N-2
 \end{array} \right.
 \end{array}
 \end{array}
 \quad (4.13)$$

Then since there is no superpotential in (4.12) all the operators in the RHS of the mapping (4.13) combine into pp which transforms in the antisymmetric representation of the $SU(2N+4)$ global symmetry as previously claimed.

4.2.2 Generalization: the $R_{N,k}$ theories

5d theories and duality $R_{N,k} \leftrightarrow R_{k,N}$

$R_{N,k}$ theories: In this subsection, we generalize the discussion of subsection 4.2.1 by considering the following two-parameter family of $5d$ theories, that we call $R_{N,k}$:

$$\begin{array}{c}
 R_{N,k} : \\
 \boxed{N+2} \text{---} \underbrace{\textcircled{N} \text{---} \textcircled{N} \text{---} \cdots \text{---} \textcircled{N}}_{k-1} \text{---} \boxed{N+2}
 \end{array}
 \quad (4.14)$$

The brane web associated to the $R_{N,k}$ is shown on the left of Figure 4.5. We can perform S-duality on this brane system and we obtain the web on the right of Figure 4.5.

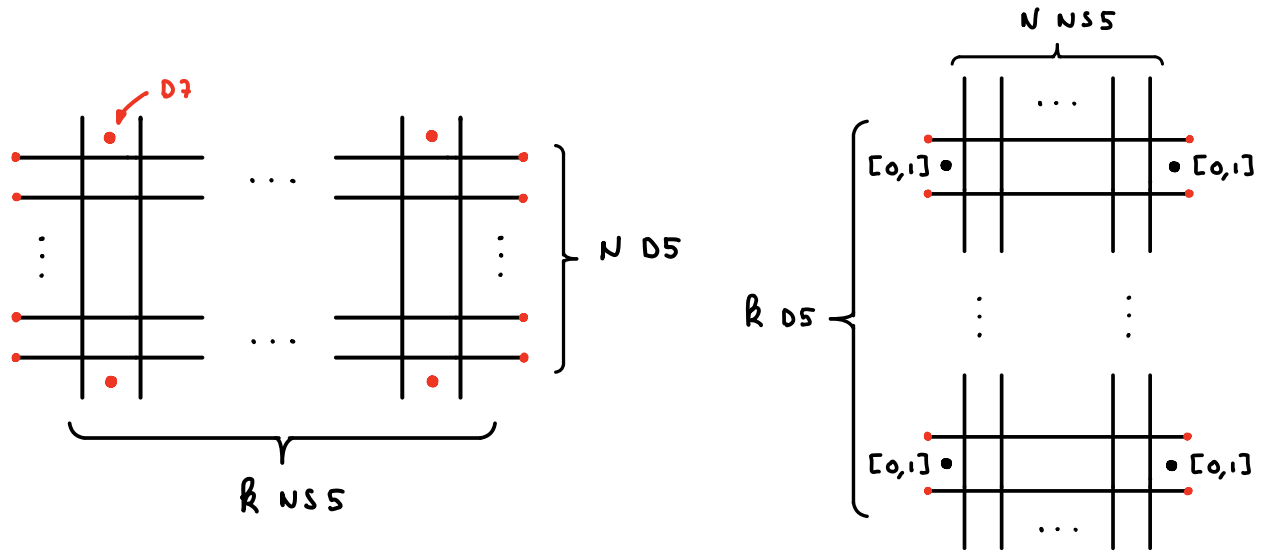

Figure 4.5: Brane setup for $(N + 2)F + SU(N)^{k-1} + (N + 2)F$ on the left and for $(k + 2)F + SU(k)^{N-1} + (k + 2)F$ for the right. The two brane systems are S-dual.

At first, it is not completely obvious how to read of the gauge theory for the S-dual theory. Let us illustrate how we can do in the case of $N = 2$ and $k = 3$, Figure 4.6:

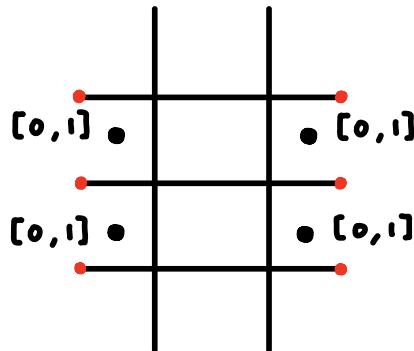

Figure 4.6: The S-dual brane system of $4F + SU(2)^2 + 4F$.

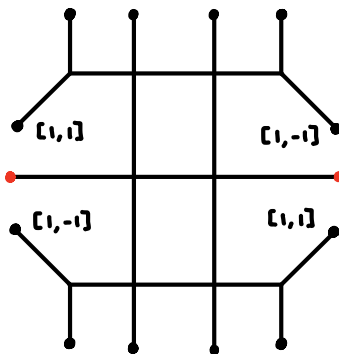

Figure 4.7: Brane system after pulling out the $[0, 1]$ 7-branes of Figure 4.6.

Then, we pull out the $[0, 1]$ 7-branes through the D5 branes. Due to the Hanany-Witten effect, we get Figure 4.7. The second step is to pull out the $[1, 1]$ and $[1, -1]$ 7-branes through the D5 branes. We get

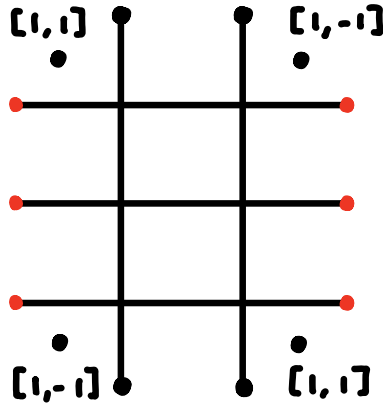

Figure 4.8: Brane system after pulling out the $[1, 1]$ and $[1, -1]$ 7-branes of Figure 4.7 through the D5.

The final step is to pull out the $[1, 1]$ and $[1, -1]$ 7-branes through the NS5 brane. We get

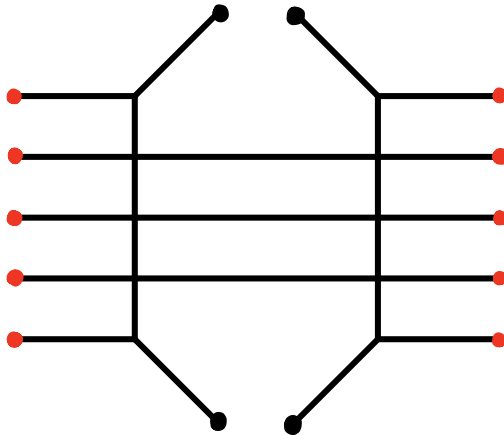

Figure 4.9: Brane system after pulling out the $[1, 1]$ and $[1, -1]$ 7-branes of Figure 4.8 through the NS5. In this frame, it is easy to read of the gauge theory that is $SU(3) + 10F$.

It is easy to generalize the previous discussion and we find that the brane system on the right of Figure 4.5 describes $(k + 2)F + SU(k)^{N-1} + (k + 2)F$ gauge theory which corresponds to $R_{k,N}$. This result is valid for arbitrary N and k . Therefore we have shown that $R_{N,k}$ and $R_{k,N}$ are UV duals.

As in the previous section, for general k and N , there is a third dual frame involving an Usp gauge group or an antisymmetric field. While this dual frame will not play a role in $4d$, let us discuss it for completeness. In order to get this $5d$ UV dual, we assume $N \geq k$ and distinguish between the case k even and k odd (as we will discuss later, also the $6d$ UV completion depends on the parity of this parameter).

k even: $k = 2l$

The $5d$ triality reads

$$\begin{array}{c}
 \star_1) \\
 \begin{array}{c}
 \boxed{N+2} \text{---} \underbrace{\textcircled{N} \text{---} \textcircled{N} \text{---} \dots \text{---} \textcircled{N}}_{2l-1} \text{---} \boxed{N+2} \\
 \end{array}
 \end{array}
 \tag{4.15}$$

$$\begin{array}{c}
 \star_2) \\
 \begin{array}{c}
 \textcircled{2N-2l} \text{---} \underbrace{\textcircled{2N-2l+4} \text{---} \textcircled{2N-2l+8} \text{---} \dots \text{---} \textcircled{2N+2l-4}}_{l-1} \text{---} \boxed{2N+2l+2} \\
 \end{array}
 \end{array}
 \tag{4.16}$$

$$\begin{array}{c}
 \star_3) \\
 \begin{array}{c}
 \boxed{2l+2} \text{---} \underbrace{\textcircled{2l} \text{---} \textcircled{2l} \text{---} \dots \text{---} \textcircled{2l}}_{N-1} \text{---} \boxed{2l+2} \\
 \end{array}
 \end{array}
 \tag{4.17}$$

First remark, if we put $l = 1$ we recover the triality studied in section 4.2.1. The logic to understand why these theories are UV duals is the same as before. We start from the brane system in Figure 4.10 describing a $6d$ theory. Then we compactify this system into an S^1 and we perform T-duality along the compactified dimension. The $O8^-$ plane becomes two $O7^-$. Then we have the choice to resolve one or the two $O7$. If we resolve the two, we get the theory $\star_1)$ and if we resolve only one, we get $\star_2)$. Finally, as we have seen, $\star_1)$ and $\star_3)$ are S-dual one to each other. We have been very brief about the derivation because all the details can be found in [190, 191].

k odd: $k = 2l + 1$

Using similar arguments [190, 191] show that the triality reads

$$\begin{array}{c}
 \star_1) \\
 \begin{array}{c}
 \boxed{N+2} \text{---} \underbrace{\textcircled{N} \text{---} \textcircled{N} \text{---} \dots \text{---} \textcircled{N}}_{2l} \text{---} \boxed{N+2} \\
 \end{array}
 \end{array}
 \tag{4.18}$$

$$\begin{array}{c}
 \star_2) \\
 \begin{array}{c}
 \textcircled{2N-2l+1} \text{---} \underbrace{\textcircled{2N-2l+5} \text{---} \textcircled{2N-2l+9} \text{---} \dots \text{---} \textcircled{2N+2l-3}}_{l-1} \text{---} \boxed{2N+2l+3} \\
 \end{array}
 \end{array}
 \tag{4.19}$$

*3)

$$\begin{array}{c}
 \boxed{2l+3} - \underbrace{\left(\textcircled{2l+1} - \textcircled{2l+1} - \dots - \textcircled{2l+1} \right)}_{N-1} - \boxed{2l+3} \\
 \end{array}
 \tag{4.20}$$

6d UV completion

The 6d UV completion of the theory $R_{N,k}$, $N \geq k$, theory depends on the parity of k .

k even: $k = 2l$

The 6d completion is given by the following Type IIA brane setup [190, 191]:

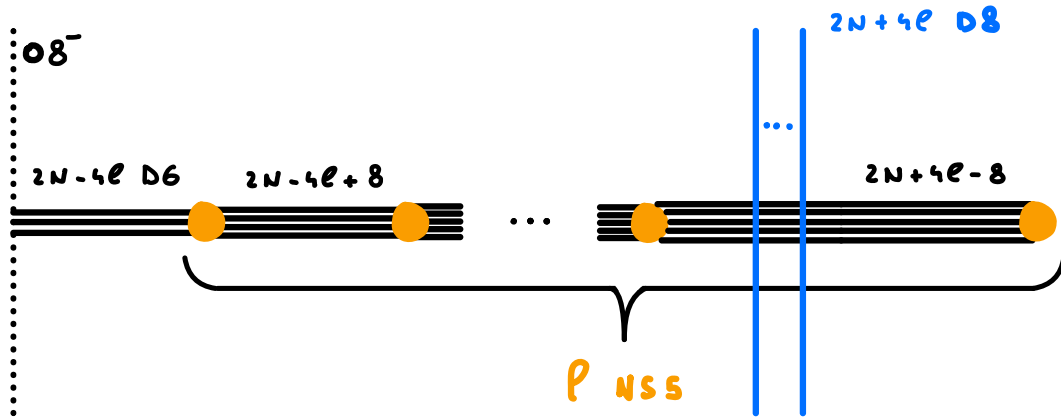

Figure 4.10: Type IIA brane setup corresponding to the 6d UV completion of $R_{N,2l}$ theory.

The gauge theory corresponding to this brane system is a linear quiver with one USp gauge node and $l - 1$ SU gauge nodes:

$$\begin{array}{c}
 \textcircled{2N-4l} - \textcircled{2N-4l+8} - \textcircled{2N-4l+16} - \dots - \textcircled{2N+4l-8} - \boxed{2N+4l} \\
 \end{array}
 \tag{4.21}$$

k odd: $k = 2l + 1$

The 6d completion is given by the following Type IIA brane setup [190, 191]:

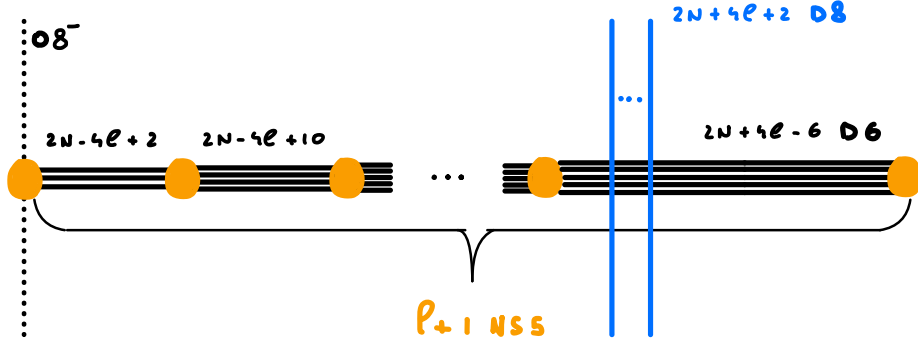

Figure 4.11: Type IIA brane setup corresponding to the 6d UV completion of $R_{N,2l+1}$ theory.

The gauge theory corresponding to this brane system is a linear quiver with l SU gauge nodes and an antisymmetric hyper attached to the first node:

$$(4.22)$$

4d duality

Having recalled the two 5d UV trialitys (4.15)-(4.17) and (4.18)-(4.20) we can run our prescription of section 4.1. We quickly realize that for generic l the theories \star_2 ((4.16) and (4.19)), that is the ones involving an USp node or an antisymmetric, cannot be made non-anomalous in 4d, this is because the ranks of the chain of SU nodes are not constant⁴. Therefore, we do not consider these theories and treat uniformly the case k even and k odd. The proposed 4d IR duality that we obtain using our prescription is the following:

$\star_1)$

$$\mathcal{W} = (k-2) \text{ Triangles} + \text{Flip}[Ll; Rr; L^N; R^N; L B_1 \dots B_{k-2} R; l^2 B_1^{N-2} \dots B_{k-2}^{N-2} r^2] + \sum_{i=1}^{k-2} \text{Flip}[B_i^N]$$

$$(4.23)$$

⁴It is an interesting question if the prescription can be generalized to include quivers with non constant ranks for the SU nodes.

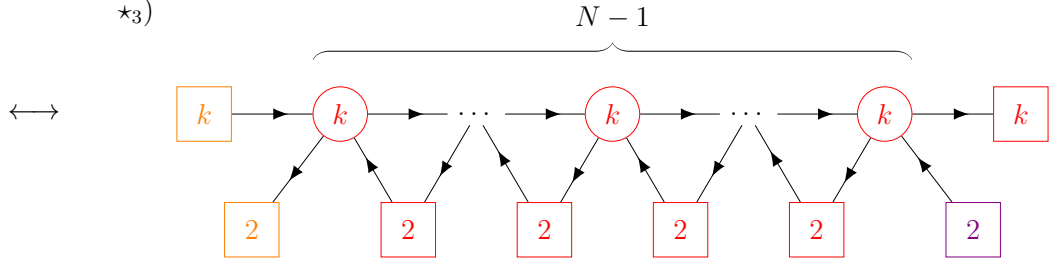

$$\mathcal{W} = (N-2) \text{ Triangles} + \text{Flip}[\tilde{L}\tilde{l}; \tilde{R}\tilde{r}; \tilde{L}^k; \tilde{R}^k; \tilde{L}\tilde{B}_1 \dots \tilde{B}_{N-2}\tilde{R}; \tilde{l}^2 \tilde{B}_1^{k-2} \dots \tilde{B}_{N-2}^{k-2} \tilde{r}^2] + \sum_{i=1}^{N-2} \text{Flip}[\tilde{B}_i^k] \quad (4.24)$$

We have denoted the fields appearing in (4.24) with a tilde. We remark that in order to get a non-anomalous $4d$ quiver we have to split the flavor symmetries. For example, $SU(N+2)$ is split into $SU(2)$ and $SU(N)$. The expression of the superpotential in (4.23) and (4.24) will be justified in the next section. The mapping of the chiral ring generators is

$$\left\{ \begin{array}{l} \text{Flipper}[LB_1 \dots B_{k-2}R] \\ L^{N-2} B_1^{N-2} \dots B_{k-2}^{N-2} r^2 \\ l^2 B_1^{N-2} \dots B_{k-2}^{N-2} R^{N-2} \end{array} \right\} \iff \left\{ \begin{array}{l} \tilde{D}_i \tilde{B}_{i+1}^{k-1} \dots \tilde{B}_j^{k-1} \tilde{V}_{j+1} \quad i=1, \dots, N-4 \ \& \ j=i+1, \dots, N-3 \\ \tilde{l} \tilde{B}_1^{k-1} \dots \tilde{B}_i^{k-1} \tilde{V}_{i+1} \quad i=1, \dots, N-3 \\ \tilde{D}_{j+1} \tilde{B}_{i+2}^{k-1} \dots \tilde{B}_{N-2}^{k-1} \tilde{r} \quad j=0, \dots, N-4 \\ \tilde{V}_1; \tilde{D}_1 \tilde{V}_2; \tilde{D}_2 \tilde{V}_3; \dots; \tilde{D}_{N-3} \tilde{V}_{N-2}; \tilde{D}_{N-2} \tilde{r} \\ \text{Flipper}[\tilde{B}_i^k] \quad i=1, \dots, N-2 \\ \tilde{l} \tilde{B}_1^{k-1} \dots \tilde{B}_{N-2}^{k-1} \tilde{r} \\ \text{Flipper}[\tilde{L}^k]; \text{Flipper}[\tilde{R}^k] \end{array} \right. \quad (4.25)$$

The total number of d.o.f on both sides is $2N^2 - N$.

$$\left\{ \begin{array}{l} D_i B_{i+1}^{N-1} \dots B_j^{N-1} V_{j+1} \quad i=1, \dots, k-4 \ \& \ j=i+1, \dots, k-3 \\ l B_1^{N-1} \dots B_i^{N-1} V_{i+1} \quad i=1, \dots, k-3 \\ D_{j+1} B_{i+2}^{N-1} \dots B_{k-2}^{N-1} r \quad j=0, \dots, k-4 \\ lV_1; D_1 V_2; D_2 V_3; \dots; D_{k-3} V_{k-2}; D_{k-2} r \\ \text{Flipper}[B_i^N] \quad i=1, \dots, k-2 \\ l B_1^{N-1} \dots B_{N-2}^{N-1} r \\ \text{Flipper}[L^N]; \text{Flipper}[R^N] \end{array} \right\} \iff \left\{ \begin{array}{l} \text{Flipper}[\tilde{L}\tilde{B}_1 \dots \tilde{B}_{N-2}\tilde{R}] \\ \tilde{L}^{k-2} \tilde{B}_1^{k-2} \dots \tilde{B}_{N-2}^{k-2} \tilde{r}^2 \\ \tilde{l}^2 \tilde{B}_1^{k-2} \dots \tilde{B}_{N-2}^{k-2} \tilde{R}^{k-2} \end{array} \right. \quad (4.26)$$

The total number of d.o.f on both sides is $2k^2 - k$.

★₁)

(4.30)

★₁)

$\mathcal{W} = 0$ $\mathcal{W} = 0$

(4.31)

Once again following the mapping of the basic dualities we can see that the operators in the LHS of (4.25)-(4.28) are mapped in the frame (4.31) in the following way

★₁) (4.31) (4.32)

$$\begin{cases} \text{Flipper}[LB_1 \dots B_{k-2}R] \\ L^{N-2} B_1^{N-2} \dots B_{k-2}^{N-2} r^2 \\ l^2 B_1^{N-2} \dots B_{k-2}^{N-2} R^{N-2} \end{cases} \iff nn$$

The total number of d.o.f on both sides is $2N^2 - N$.

$$\begin{cases} D_i B_{i+1}^{N-1} \dots B_j^{N-1} V_{j+1} & i = 1, \dots, k-4 \ \& \ j = i+1, \dots, k-3 \\ l B_1^{N-1} \dots B_i^{N-1} V_{i+1} & i = 1, \dots, k-3 \\ D_{j+1} B_{i+2}^{N-1} \dots B_{k-2}^{N-1} r & j = 0, \dots, k-4 \\ lV_1; D_1V_2; D_2V_3; \dots; D_{k-3}V_{k-2}; D_{k-2}r \\ \text{Flipper}[B_i^N] & i = 1, \dots, k-2 \\ l B_1^{N-1} \dots B_{N-2}^{N-1} r \\ \text{Flipper}[L^N]; \text{Flipper}[R^N] \end{cases} \iff kk$$

The total number of d.o.f on both sides is $2k^2 - k$.

$$\begin{cases} \text{Flipper}[Ll]; \text{Flipper}[Rr] \\ L^{N-1} B_1^{N-1} \dots B_i^{N-1} V_{i+1} & i = 0, \dots, k-3 \\ D_{k-2-i} B_{k-2-i+1}^{N-1} \dots B_{k-2}^{N-1} R^{N-1} & i = 0, \dots, k-3 \\ L^{N-1} B_1^{N-1} \dots B_{k-2}^{N-1} r \\ l B_1^{N-1} \dots B_{k-2}^{N-1} R^{N-1} \end{cases} \iff kbn$$

The total number of d.o.f on both sides is $4kN$.

$$\text{Flipper}[l^2 B_1^{N-1} \dots B_{k-2}^{N-1} r^2] \iff bb$$

The total number of d.o.f on both sides is 1. (4.35)

Since in (4.31) we reach a frame where N and k enter symmetrically, it proves the duality $T_{N,k} \leftrightarrow T_{k,N}$ in $4d$, that is (4.23) \leftrightarrow (4.24) and the mapping (4.25)-(4.28).

4.3 Second class: systems with two $O7$ planes, the $A_{n,m}$ theories and its dual

In this section, we want now to test our prescription with another family of theories. We consider theories which involve two $O7^-$ planes in the Type IIB brane setup. For each $O7$, the $5d$ quivers contain either an SU gauge group with antisymmetric or an USp gauge node, depending on whether a $NS5$ is stuck at the orientifold plane or not. We are going to see that also in this case our prescription works and leads to $4d$ dualities. Contrary to the previous family, we are not able to prove the $4d$ dualities using basic Seiberg dualities. The $4d$ dualities that we obtain are more complicated, but are still a rather non-trivial check of the $5d$ -to- $4d$ prescription.

4.3.1 A simple class: $A_{n,1}$ theory

Concretely, in this section we will study the following $5d$ KK theory, that we call $A_{n,1}$.



$$(4.36)$$

$A_{n,1}$ admits a dual theory. The form of the dual depends on the parity of n .

n odd: 5d duality $A_{2N+1,1} \leftrightarrow U_{2N+1,1}$

We call $U_{2N+1,1}$ the dual of $A_{2N+1,1}$ and the duality statement is the following

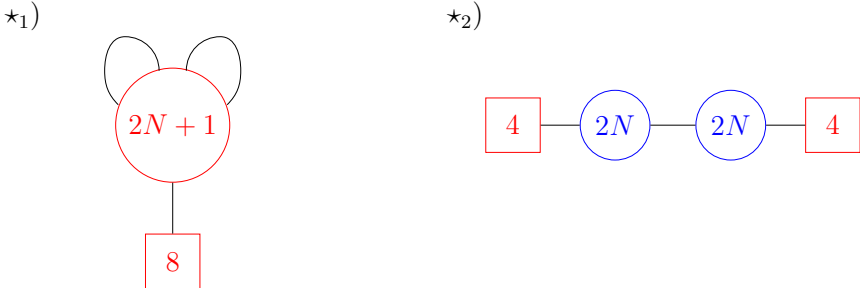

$$(4.37)$$

The analysis showing the UV duality (4.37) is morally the same as in the previous family. We have to start with the $6d$ type IIA brane setup shown in Figure 4.14, do the circle reduction,

6d UV completion

n odd: $n = 2N + 1$

The UV completion of the 5d theories in (4.37) is a 6d given by the following Type IIA brane setup [190, 191]:

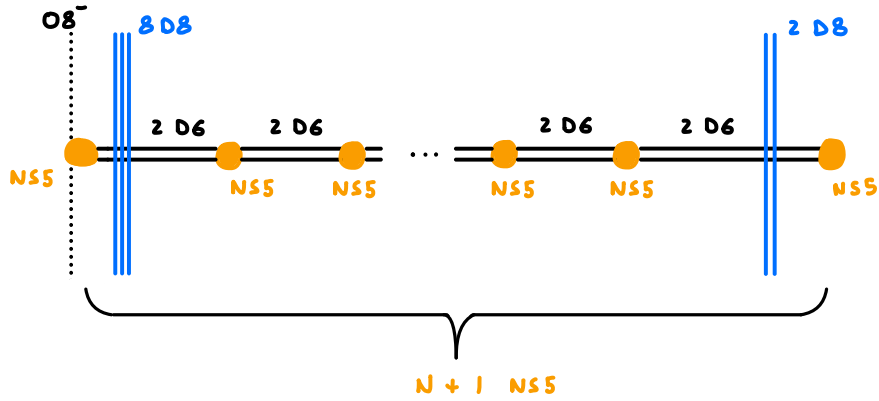

Figure 4.14: Type IIA brane setup corresponding to the 6d UV completion of $A_{2N+1,1}$.

On the tensor branch, the theory is given by the following gauge theory:

$$\boxed{8} - \underbrace{\left(\textcircled{2} - \textcircled{2} - \dots - \textcircled{2} \right)}_N - \boxed{2} \tag{4.39}$$

n even: $n = 2N$

The UV completion of the 5d theories in (4.38) is a 6d given by the following Type IIA brane setup [190, 191]:

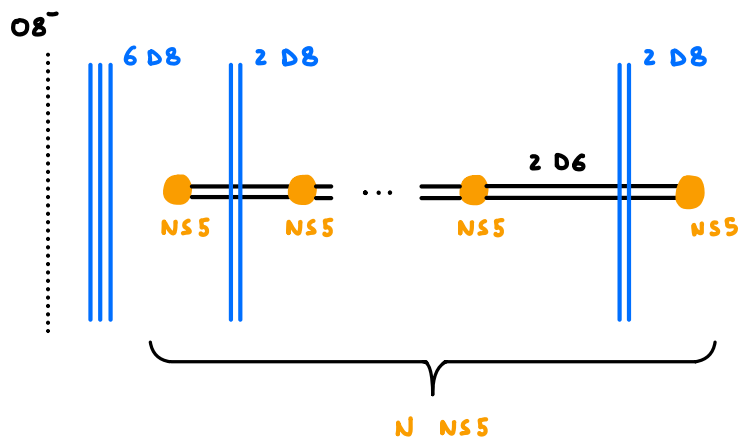

Figure 4.15: Type IIA brane setup corresponding to the 6d UV completion of $A_{2N,1}$.

On the tensor branch, the theory is given by the following gauge theory:

$$(4.40)$$

4d duality

n odd

Applying our prescription of section 4.1 to the KK duality (4.37) leads to the following 4d theories that we claim are IR dual

★₁)

$\mathcal{W} = \text{Flip}[a^N q; \tilde{a}^N \tilde{q}]$

★₂)

$\mathcal{W} = 1 \text{ Triangle} + \sum_{i=0}^{N-1} \text{Flip}[q_L (bb)^i q_L; q_R (bb)^i q_R; q_L b (bb)^i q_R]$

$$(4.41)$$

Of course, our prescription does not tell us what the precise flippers, which are crucial in order for the duality to be correct. In section 4.3.2 we provide a strategy to obtain such flippers, and we apply it to a quiver duality that generalizes (4.41).

The mapping of the chiral ring generators is given by

<p>★₁)</p> <p>$q \tilde{q} (a \tilde{a})^i$</p> <p>$q q \tilde{a} (a \tilde{a})^i$</p> <p>$\tilde{q} \tilde{q} a (a \tilde{a})^i$</p> <p>$(a \tilde{a})^j$</p> <p>$\left\{ \begin{array}{l} \text{Flipper}[a^N q] \\ a^{N-1} q^3 \end{array} \right.$</p> <p>$\left\{ \begin{array}{l} \text{Flipper}[\tilde{a}^N \tilde{q}] \\ \tilde{a}^{N-1} \tilde{q}^3 \end{array} \right.$</p>	\iff	<p>★₂)</p> <p>$\text{Flipper}[q_L b (bb)^{N-1-i} q_R]$</p> <p>$\text{Flipper}[q_L (bb)^{N-1-i} q_L]$</p> <p>$\text{Flipper}[q_R (bb)^{N-1-i} q_R]$</p> <p>$(bb)^j$</p> <p>$q_L V_L$</p> <p>$q_R D_R$</p>	<p>$i = 0, \dots, N-1$</p> <p>$i = 0, \dots, N-1$</p> <p>$i = 0, \dots, N-1$</p> <p>$j = 1, \dots, N$</p>
---	--------	---	---

$$(4.42)$$

For $N = 1$, we go back to the situation (4.4)-(4.5). For generic N , we don't have a proof of the duality (4.41) involving more basic Seiberg dualities. The non-trivial check of this duality is the matching of the 't Hooft anomalies and of the central charges with a -maximization.

n even

In this case the $4d$ duality constructed from the $5d$ duality (4.38) is

★₁)

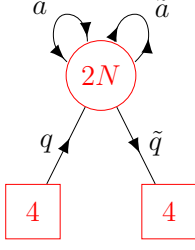

$$\mathcal{W} = \text{Flip}[a^N; \tilde{a}^N] + \sum_{j=0}^{\lfloor \frac{N-1}{2} \rfloor} \text{Flip}[q (a\tilde{a})^j \tilde{q}] + \sum_{i=0}^{\lfloor \frac{N-2}{2} \rfloor} \text{Flip}[\tilde{a} (a\tilde{a})^i q^2; a (a\tilde{a})^i \tilde{q}^2]$$

★₂)

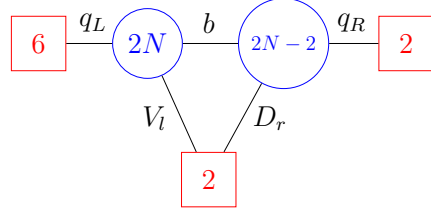

$$\mathcal{W} = 1 \text{ Triangle} + \sum_{i=0}^{\lfloor \frac{N-2}{2} \rfloor} \text{Flip}[q_L (bb)^i q_R; q_R (bb)^i q_R; q_L b (bb)^i q_R]$$

(4.43)

To write the mapping of the chiral ring generators we have to distinguish once again between N even and odd.

N even:

★₁)

$$\begin{cases} \text{Flipper}[q\tilde{q}] \\ q (a\tilde{a})^{N-1} \tilde{q} \end{cases} \iff$$

★₂)

$$\begin{cases} \text{Flipper}[q_L q_L] \\ q_L (bb)^{N-1} q_L \\ \text{Flipper}[q_R q_R] \\ V_l^2 \end{cases}$$

(4.44)

The total number of d.o.f on both sides is 32.

$$\begin{cases} \text{Flipper}[q (a\tilde{a})^i \tilde{q}] \\ q (a\tilde{a})^{N-i-1} \tilde{q} \end{cases} \iff \begin{cases} \text{Flipper}[q_L (bb)^i q_L] \\ q_L (bb)^{N-i-1} q_L \\ \text{Flipper}[q_R (bb)^i q_R] \\ q_R (bb)^{N-i-1} q_R \end{cases} \quad i = 1, \dots, \frac{N-2}{2}$$

(4.45)

The total number of d.o.f on both sides is $16(N-2)$.

$$\begin{cases} \text{Flipper}[\tilde{a} (a\tilde{a})^j q^2] \\ \tilde{a} (a\tilde{a})^{N-j-2} q^2 \\ \text{Flipper}[a (a\tilde{a})^j \tilde{q}^2] \\ a (a\tilde{a})^{N-j-2} \tilde{q}^2 \end{cases} \iff \begin{cases} \text{Flipper}[q_L b (bb)^j q_R] \\ q_L b (bb)^{N-j-2} q_R \end{cases} \quad j = 1, \dots, \frac{N-2}{2} - 1$$

(4.46)

The total number of d.o.f on both sides is $12(N-2) - 24$.

$$\begin{cases} \text{Flipper}[\tilde{a} (a\tilde{a})^{(N-2)/2} q^2] \\ a^{N-1} q^2 \\ \text{Flipper}[a (a\tilde{a})^{(N-2)/2} \tilde{q}^2] \\ \tilde{a}^{N-1} \tilde{q}^2 \end{cases} \iff \begin{cases} \text{Flipper}[q_L b (bb)^{(N-2)/2} q_R] \\ q_L V_l \end{cases}$$

(4.47)

The total number of d.o.f on both sides is 24.

$$\begin{cases} \text{Flipper}[a^N] \\ \text{Flipper}[\tilde{a}^N] \\ a^{N-2} q^4 \\ \tilde{a}^{N-2} \tilde{q}^4 \end{cases} \iff D_r q_R \quad (4.48)$$

The total number of d.o.f on both sides is 4.

$$(a\tilde{a})^m \iff (bb)^m \quad m = 1, \dots, N-1 \quad (4.49)$$

The total number of d.o.f on both sides is $N-1$.

N **odd**:

$$\begin{array}{ccc} \star_1) & & \star_2) \\ \begin{cases} \text{Flipper}[q\tilde{q}] \\ q (a\tilde{a})^{N-1} \tilde{q} \end{cases} & \iff & \begin{cases} \text{Flipper}[q_L q_L] \\ q_L (bb)^{N-1} q_L \\ \text{Flipper}[q_R q_R] \\ V_l^2 \end{cases} \end{array} \quad (4.50)$$

The total number of d.o.f on both sides is 32.

$$\begin{cases} \text{Flipper}[q (a\tilde{a})^i \tilde{q}] \\ q (a\tilde{a})^{N-i-1} \tilde{q} \end{cases} \iff \begin{cases} \text{Flipper}[q_L (bb)^i q_L] \\ q_L (bb)^{N-i-1} q_L \\ \text{Flipper}[q_R (bb)^i q_R] \\ q_R (bb)^{N-i-1} q_R \end{cases} \quad i = 1, \dots, \frac{N-3}{2} \quad (4.51)$$

The total number of d.o.f on both sides is $16(N-3)$.

$$\text{Flipper}[q (a\tilde{a})^{(N-1)/2} \tilde{q}] \iff \begin{cases} q_L (bb)^{(N-1)/2} q_L \\ q_R (bb)^{(N-1)/2} q_R \end{cases} \quad (4.52)$$

The total number of d.o.f on both sides is 16.

$$\begin{cases} \text{Flipper}[\tilde{a} (a\tilde{a})^j q^2] \\ \tilde{a} (a\tilde{a})^{N-j-2} q^2 \\ \text{Flipper}[a (a\tilde{a})^j \tilde{q}^2] \\ a (a\tilde{a})^{N-j-2} \tilde{q}^2 \end{cases} \iff \begin{cases} \text{Flipper}[q_L b (bb)^j q_R] \\ q_L b (bb)^{N-j-2} q_R \end{cases} \quad j = 0, \dots, \frac{N-3}{2} \quad (4.53)$$

The total number of d.o.f on both sides is $12(N-1)$.

$$\begin{cases} a^{N-1} q^2 \\ \tilde{a}^{N-1} \tilde{q}^2 \end{cases} \iff q_L V_l \quad (4.54)$$

The total number of d.o.f on both sides is 12.

$$\begin{cases} \text{Flipper}[a^N] \\ \text{Flipper}[\tilde{a}^N] \\ a^{N-2} q^4 \\ \tilde{a}^{N-2} \tilde{q}^4 \end{cases} \iff D_r q_R \quad (4.55)$$

The total number of d.o.f on both sides is 4.

$$(a\tilde{a})^m \iff (bb)^m \quad m = 1, \dots, N-1 \quad (4.56)$$

The total number of d.o.f on both sides is $N-1$.

Also for this case we don't have a proof of this duality (4.43). The non-trivial check of this duality is the matching of the central charges with a -maximization.

4.3.2 Generalization: the $A_{n,m}$ theories

$A_{n,m}$ theories: In this subsection, we generalize the discussion of subsection 4.3.1 by considering the following two-parameter family of 5d theories, that we call $A_{n,m}$:

$A_{n,m}$:

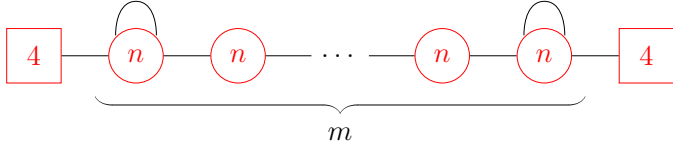

$$(4.57)$$

The duality statement will depend on the parity of the parameter n as in the last subsection.

n odd: 5d duality $A_{2N+1,m} \leftrightarrow U_{2N+1,m}$

This case is the generalization of the duality (4.37). We call the dual of $A_{2N+1,m}$, $U_{2N+1,m}$. $A_{2N+1,m}$ respectively $U_{2N+1,m}$ contains a hyper in the antisymmetric representation of the gauge group respectively a $USp(2N)$ gauge node at each end of the quiver. The quiver for $A_{2N+1,m}/U_{2N+1,m}$ is shown in (4.58)/(4.59). We have also depicted the brane systems in Figure 4.16. The claim is that $A_{2N+1,m}$ and $U_{2N+1,m}$ are UV dual. The analysis of the brane systems that lead to this duality can be found in [190].

★₁) $A_{2N+1,m}$:

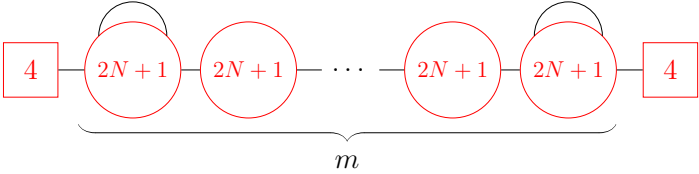

$$(4.58)$$

★₂) $U_{2N+1,m}$:

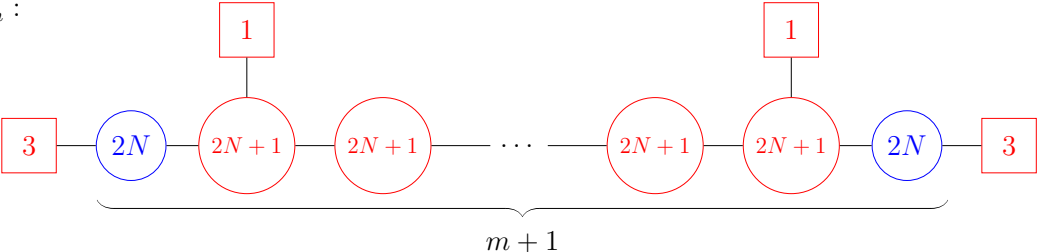

$$(4.59)$$

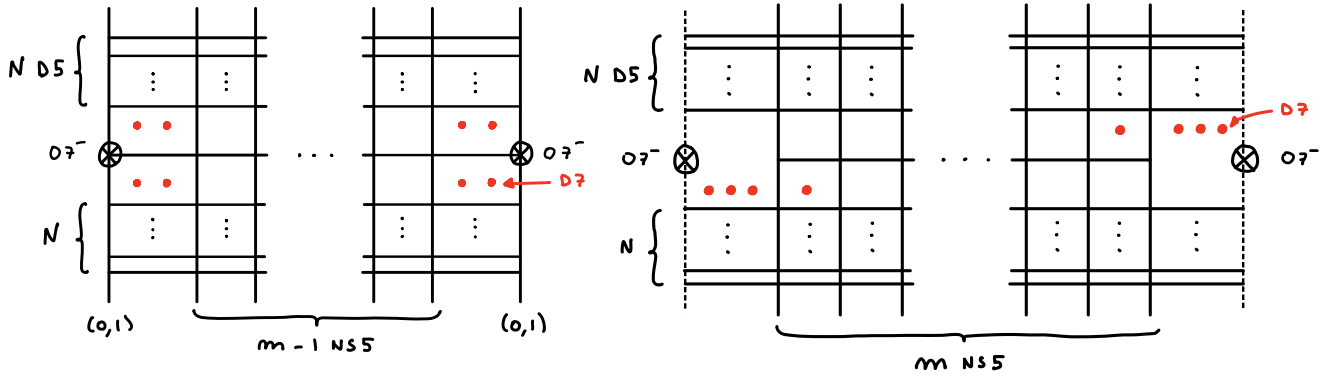

Figure 4.16: Brane setup for $A_{2N+1,m}$ on the left with an $NS5$ stuck on each $O7^-$ plane and for $U_{2N+1,m}$ on the right.

6d UV completion

The UV completion of the 5d theories in (4.58)-(4.59) is a 6d given by the following Type IIA brane setup [190, 191]:

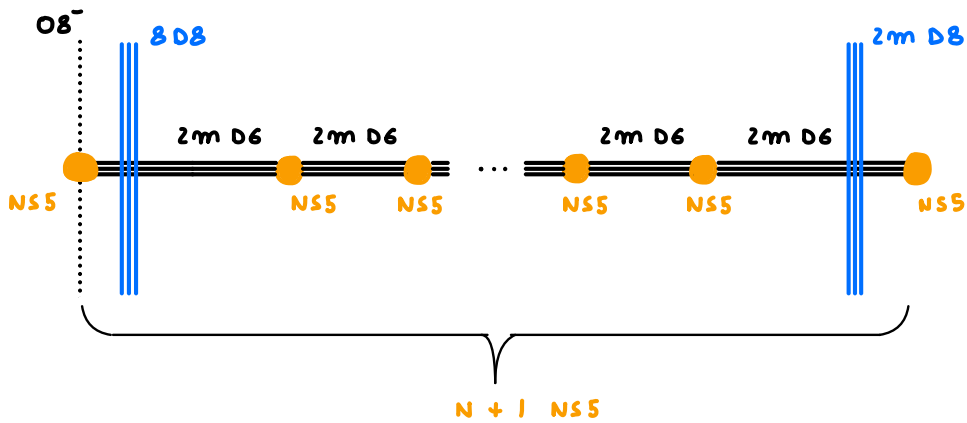
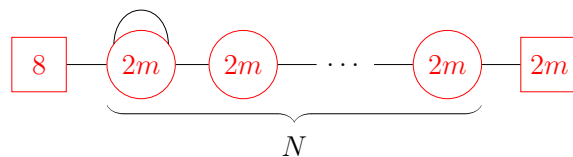

Figure 4.17: Type IIA brane setup corresponding to the 6d UV completion of $A_{2N+1,m}$.

On the tensor branch, the system flows to the following gauge theory:



(4.60)

4d duality

Our prescription of section 4.1 applied to the 5d duality (4.58)-(4.59) gives the following 4d duality

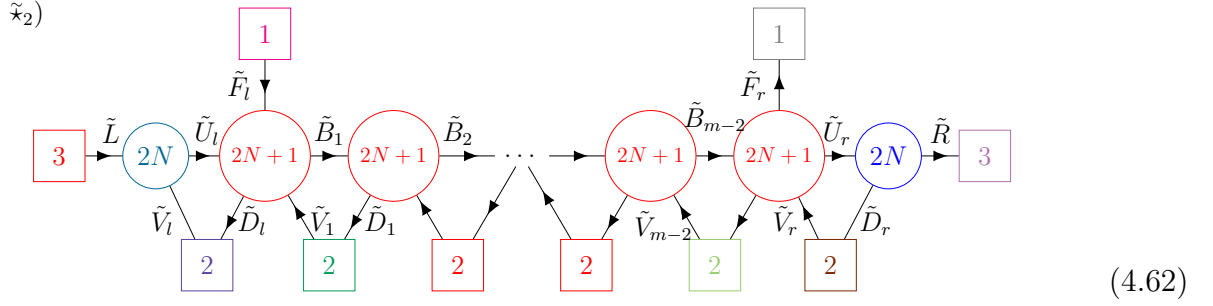
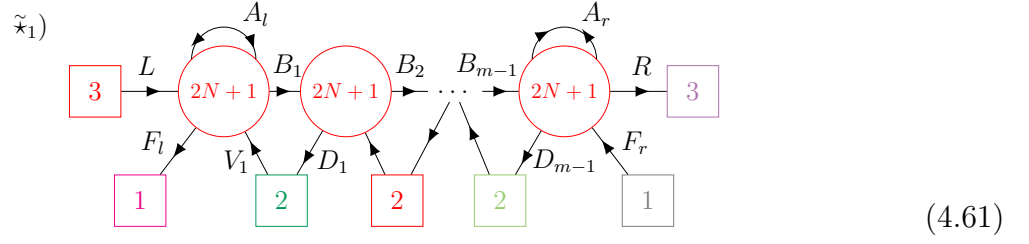

Without the flippers, these two theories are *not* dual to each other.

Strategy to get the set of flippers

In order to obtain the correct set of flippers to make $\tilde{\mathfrak{X}}_1$) and $\tilde{\mathfrak{X}}_2$) dual, we did the following procedure.

Starting with $\tilde{\mathfrak{X}}_1$) and do the following operations:

- deconfinement of the two antisymmetric
- m Seiberg dualities on the m SU nodes
- CSST duality on the left SU(2)
- m-2 confinements

We get

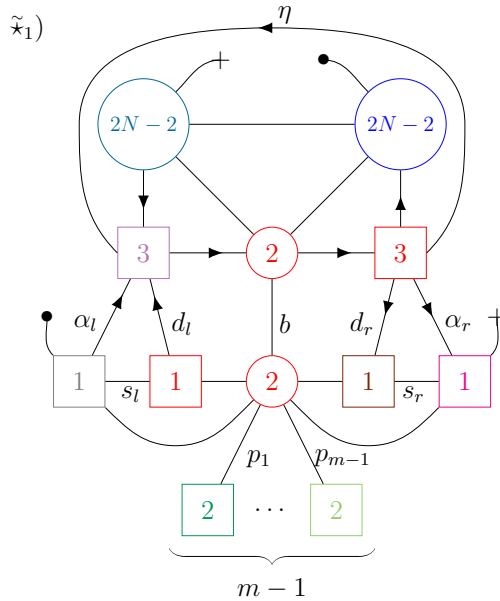

$$\mathcal{W} = 6 \text{ Quartic} + 6 \text{ Triangles}$$

$$+ \text{Flip}[bb] + \sum_{i=1}^{m-1} \text{Flip}[p_i p_i]$$

(4.63)

Then, we start with $\tilde{\star}_2$) and do the following operations:

- m-1 Seiberg dualities on the m-1 SU nodes
- CSST duality on the left SU(2)
- m-3 confinements

We get

$\tilde{\star}_2$)

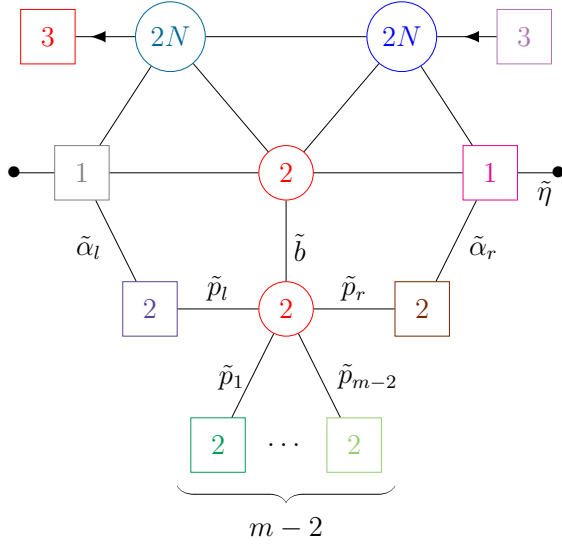

$$\mathcal{W} = 2 \text{Quartic} + 4 \text{Triangles}$$

$$+ \text{Flip}[\tilde{b} \tilde{b}; \tilde{p}_l \tilde{p}_l; \tilde{p}_r \tilde{p}_r] + \sum_{i=1}^{m-2} \text{Flip}[\tilde{p}_i \tilde{p}_i]$$

(4.64)

Then we can play with (4.63) and (4.64) to make manifest a bigger flavor symmetry group. Concretely, we flip the following set of operators in (4.63) ($\alpha_l; \alpha_r; d_l; d_r; s_l; s_r; \eta; \sigma_i$) and in (4.64) ($\tilde{\alpha}_l; \tilde{\alpha}_r; \tilde{\eta}; \tilde{\sigma}_l; \tilde{\sigma}_r; \tilde{\sigma}_i$). We therefore consider the following theories

$\tilde{\star}_1$)

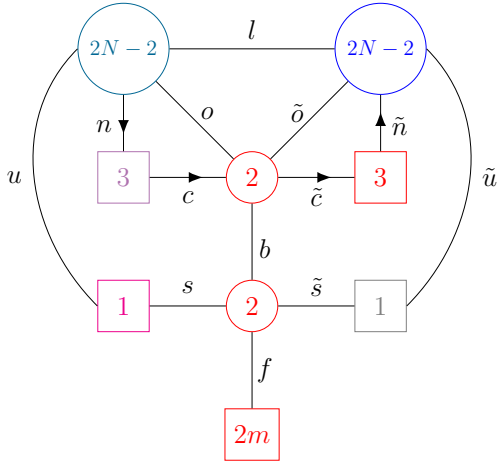

$$\mathcal{W} = 2 \text{Quartic} + 3 \text{Triangles}$$

$\tilde{\star}_2$)

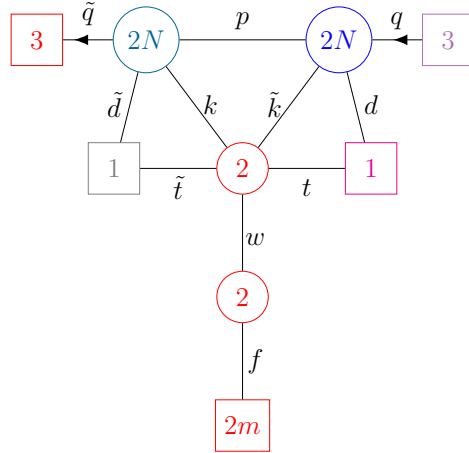

$$\mathcal{W} = 3 \text{Triangles}$$

(4.65)

Once again, at this stage $\tilde{\star}_1$) and $\tilde{\star}_2$) are *not* dual. Now to make progress, we will focus on the case $N = 1$ and generic m . Moreover we saw that in the $m = 1$ case we had to flip the whole

towers in the frame \star_2) (4.41). Therefore we decide to study the following theory

\star_2)

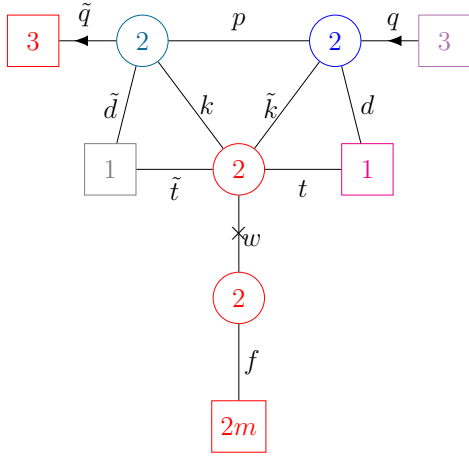

$$\mathcal{W} = 3 \text{ Triangles} + \text{Flip}[ww; qq; qd; \tilde{q}\tilde{q}; \tilde{q}\tilde{d}; qp\tilde{q}; qp\tilde{d}; \tilde{q}pd; dp\tilde{d}]$$

(4.66)

Now we start by doing a CSST duality on the $U_{sp}(2) \equiv SU(2)$. We get

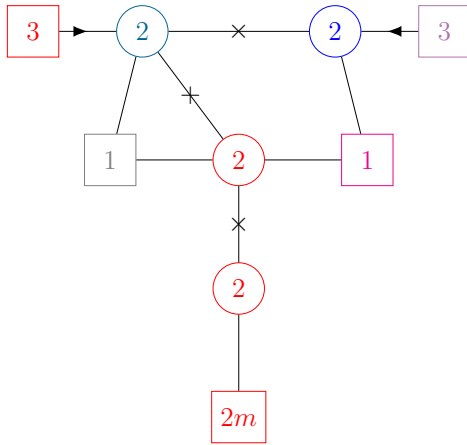

$$\mathcal{W} = 1 \text{ Triangle} + 1 \text{ Quartic} + \text{Flip}[pp; kk; ww; qq; qd; qp\tilde{q}; \tilde{q}pd; qp\tilde{d}; dp\tilde{d}]$$

(4.67)

Then we use the IP confinement (2.88) on the $U_{sp}(2)$. We obtain

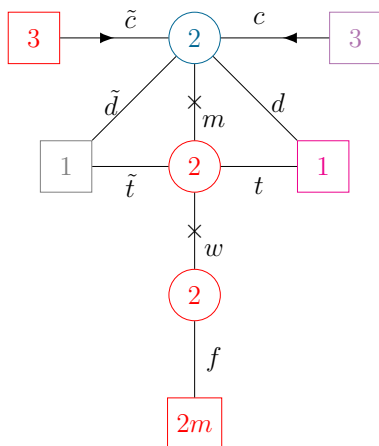

$$\mathcal{W} = 2 \text{ Triangles} + \text{Flip}[mm; ww; \tilde{c}\tilde{d}; cd; c\tilde{c}; d\tilde{d}]$$

(4.68)

The last step is the IP confinement on the middle $SU(2)$ to get

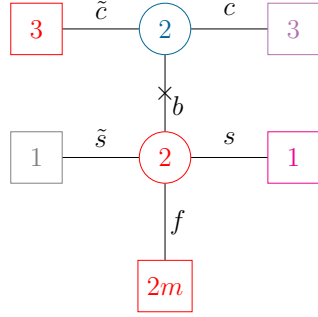

$$\mathcal{W} = \text{Flip}[bb; c\tilde{c}; cb\tilde{s}; \tilde{c}bs; bsb\tilde{s}]$$

(4.69)

Which is of the form $\tilde{\star}_1$ in (4.65) specified to the case $N = 1$. This result motivates the following educated guess for generic N :

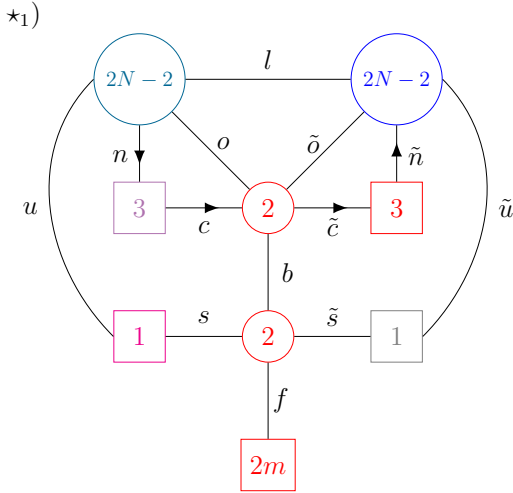

$$\mathcal{W} = 2 \text{Quartic} + 3 \text{Triangles} \\ + \text{Flip}[bb, c\tilde{c}, cb\tilde{s}, \tilde{c}bs, bsb\tilde{s}]$$

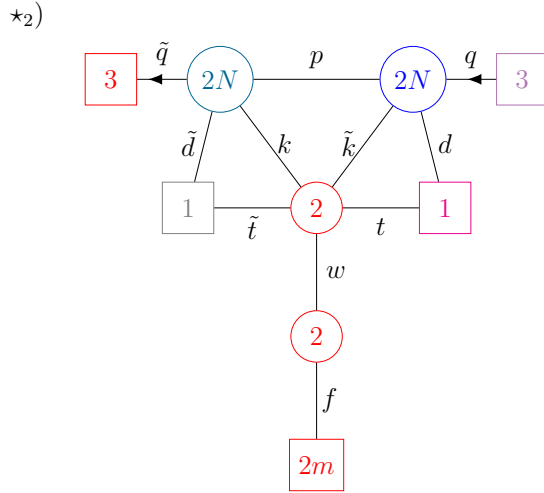

$$\mathcal{W} = 3 \text{Triangles} + \text{Flip}[ww] \\ + \sum_{i=0}^{N-1} \text{Flip}[q(pp)^i q; \tilde{q}(pp)^i \tilde{q}; q(pp)^i d; \tilde{q}(pp)^i \tilde{d}; \\ qp(pp)^i \tilde{q}; qp(pp)^i \tilde{d}; \tilde{q}p(pp)^i d; dp(pp)^i \tilde{d}] \quad (4.70)$$

We claim that \star_1) and \star_2) in (4.70) are dual. For generic N and m , we don't have a proof of this statement. However we provided a proof for the special case of $N = 1$ and generic m . The first non-trivial test of this duality is the matching of the central charges for generic N and m . Then we can match 't Hooft anomalies. We have reported the computation in the appendix C.1.

The mapping of the chiral ring generators is given by

$$\begin{array}{lll}
\star_1) & \star_2) & \\
n (ll)^i n & \text{Flipper}[q (pp)^{N-1-i} q] & i = 0, \dots, N-2 \\
\tilde{n} (ll)^i \tilde{n} & \text{Flipper}[\tilde{q} (pp)^{N-1-i} \tilde{q}] & i = 0, \dots, N-2 \\
n (ll)^i u & \text{Flipper}[q (pp)^{N-1-i} d] & i = 0, \dots, N-2 \\
\tilde{n} (ll)^i \tilde{u} & \text{Flipper}[\tilde{q} (pp)^{N-1-i} \tilde{d}] & i = 0, \dots, N-2 \\
n l (ll)^i \tilde{n} & \text{Flipper}[q p (pp)^{N-2-i} \tilde{q}] & i = 0, \dots, N-2 \\
n l (ll)^i \tilde{u} & \text{Flipper}[q p (pp)^{N-2-i} \tilde{d}] & i = 0, \dots, N-2 \\
\tilde{n} l (ll)^i u & \text{Flipper}[\tilde{q} p (pp)^{N-2-i} d] & i = 0, \dots, N-2 \\
u l (ll)^i \tilde{u} & \text{Flipper}[d p (pp)^{N-2-i} \tilde{d}] & i = 0, \dots, N-2 \\
(ll)^j & (pp)^j & j = 1, \dots, N-1 \\
cbs & \text{Flipper}[q q] & \\
\tilde{c}\tilde{b}\tilde{s} & \text{Flipper}[\tilde{q} \tilde{q}] & \\
cc & \text{Flipper}[q d] & \\
\tilde{c}\tilde{c} & \text{Flipper}[\tilde{q} \tilde{d}] & \\
\text{Flipper}[c\tilde{c}] & \text{Flipper}[q p (pp)^{N-1} \tilde{q}] & \\
\text{Flipper}[c\tilde{b}\tilde{s}] & \iff \text{Flipper}[q p (pp)^{N-1} \tilde{d}] & \\
\text{Flipper}[\tilde{c}bs] & \text{Flipper}[\tilde{q} p (pp)^{N-1} d] & \\
\text{Flipper}[bsb\tilde{s}] & \text{Flipper}[d p (pp)^{N-1} \tilde{d}] & \\
s\tilde{s} & (pp)^N & \\
c\tilde{o}\tilde{u} & q\tilde{k}\tilde{t} & \\
\tilde{c}ou & \tilde{q}kt & \\
cbf & q\tilde{k}wf & \\
\tilde{c}bf & \tilde{q}kwf & \\
oo & kk & \\
\tilde{o}\tilde{o} & \tilde{k}\tilde{k} & \\
\text{Flipper}[bb] & t\tilde{t} & \\
sf & twf & \\
\tilde{s}f & \tilde{t}wf & \\
ff & ff &
\end{array} \tag{4.71}$$

n even: 5d duality $A_{2N,m} \leftrightarrow U_{2N,m}$

This case is the generalization of the duality (4.38). We call the dual of $A_{2N,m}$, $U_{2N,m}$. $A_{2N,m}$ respectively $U_{2N,m}$ contains a hyper in the antisymmetric representation of the gauge group respectively a USp gauge node at each end of the quiver. The quiver for $A_{2N,m}/U_{2N,m}$ is shown in (4.72)/(4.73). We have also depicted the brane systems in Figure 4.18. The claim is that $A_{2N,m}$ and $U_{2N,m}$ are UV dual. The analysis of the brane systems that lead to this duality can be found in [190].

$$\star_1) A_{2N,m} : \quad \begin{array}{c} \boxed{4} \text{---} \textcircled{2N} \text{---} \textcircled{2N} \text{---} \dots \text{---} \textcircled{2N} \text{---} \textcircled{2N} \text{---} \boxed{4} \\ \underbrace{\hspace{10em}}_m \end{array} \tag{4.72}$$

★₂) $U_{2N,m}$:

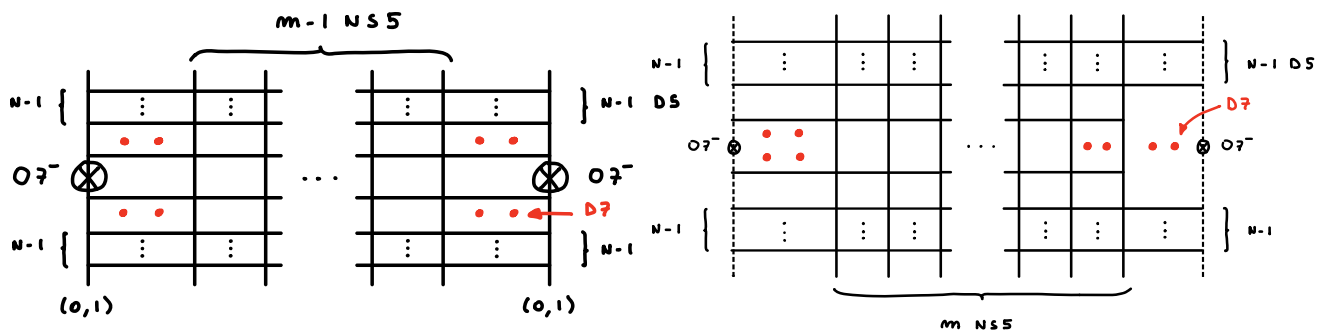
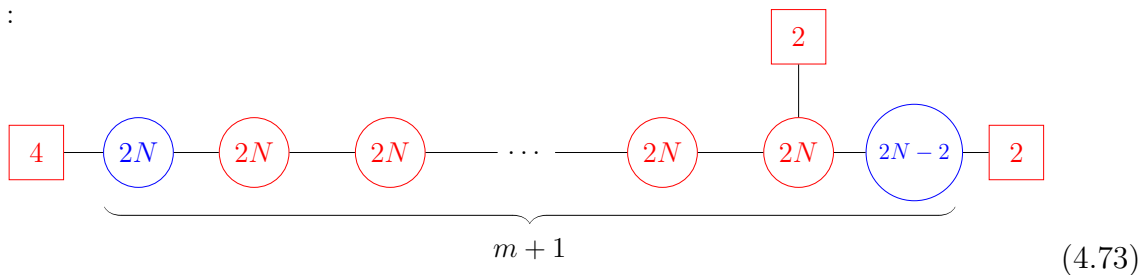

Figure 4.18: Brane setup for $A_{2N,m}$ on the left with an $NS5$ stuck on each $O7^-$ plane and for $U_{2N,m}$ on the right.

6d UV completion

The UV completion of the 5d theories in (4.72)-(4.73) is a 6d given by the following Type IIA brane setup [190, 191]:

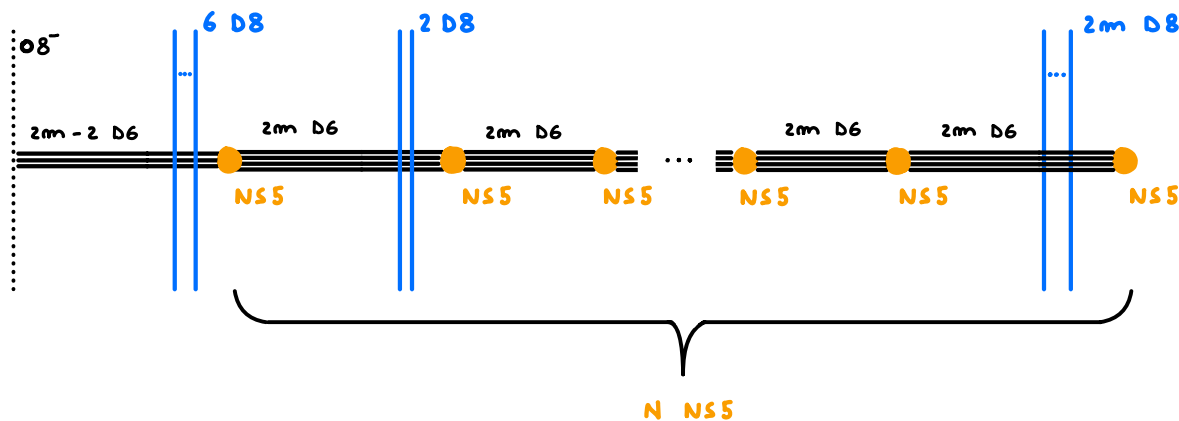

Figure 4.19: Type IIA brane setup corresponding to the 6d UV completion of $A_{2N,m}$.

On the tensor branch, the system flows to the following gauge theory:

(4.74)

4d duality

Our prescription of Sec.4.1 applied to the 5d duality (4.72)-(4.73) gives the following 4d duality

(4.75)

(4.76)

Without the flippers, these two theories are *not* dual to each other.

Strategy to get the set of flippers

Once again in order to find the correct set of flippers we do a similar procedure as in the odd case. We first put the two theories $\tilde{\kappa}_1$) and $\tilde{\kappa}_2$) in a simpler form. It means that we do to each theories the following set of manipulations.

Starting with $\tilde{\kappa}_1$):

- deconfinement of the two antisymmetric
- m Seiberg dualities on the m SU nodes
- CSST duality on the left SU(2)
- m-2 confinements

We end up with a frame similar to (4.63).

Starting with $\tilde{\kappa}_2$):

- m-1 Seiberg dualities on the m-1 SU nodes

- CSST duality on the left $SU(2)$
- m-3 confinements

We end up with a frame similar to (4.64).

Then we arrange the two resulting theories by a flipping procedure equivalent to the one after (4.64). We are lead to consider the following theories

$\tilde{\star}_1)$

$\mathcal{W} = 2 \text{ Quartic} + 3 \text{ Triangles}$

$\tilde{\star}_2)$

$\mathcal{W} = 3 \text{ Triangles}$

(4.77)

Once again at this stage $\tilde{\star}_1)$ and $\tilde{\star}_2)$ are *not* dual, it misses the set of flippers in both sides. In the odd case, in order to make progress at this stage we studied the $N = 1$ case. It allowed us to come up with the educated guess (4.70) for generic N . This educated guess turned out to be correct because it passes the non-trivial checks of matching the central charges as well as 't Hooft anomalies. Now, for the even case we consider a different procedure to obtain an educated guess. We do the following steps:

- Start with the theory with no flipper
- Compute the R-charges of all the chiral ring generators
- Flip all operators with R-charge *less* than 1
- Compute again all R-charges
- Flip additional chiral ring generators with R-charge *less* than 1 if present
- Repeat this procedure until reaching a frame with only chiral ring generators with R-charge *bigger* than 1

After applying these algorithm to (4.77) we obtain

★₁)

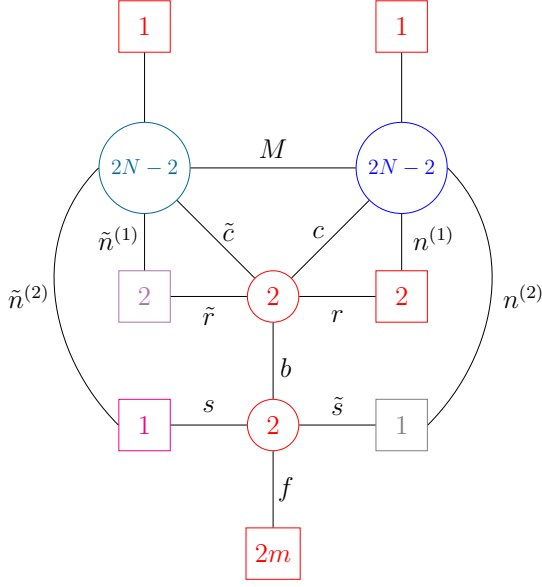

★₂)

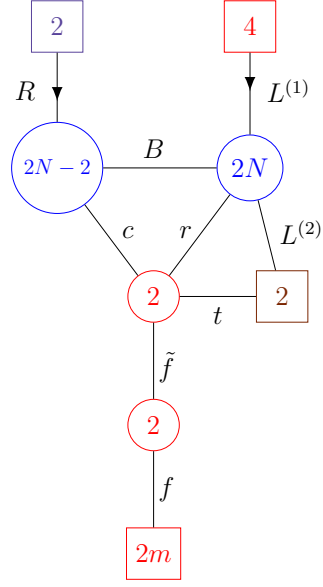

$$\mathcal{W} = 2 \text{Quartic} + 3 \text{Triangles} + \text{Flip}[b b]$$

$$\begin{aligned}
& + \sum_{a=0}^{\lfloor \frac{N-4}{2} \rfloor} \text{Flip}[n^{(1)} (M M)^a \tilde{n}^{(1)}] \\
& + \sum_{b=0}^{\lfloor \frac{N-3}{2} \rfloor} \text{Flip}[n^{(1)} (M M)^b n^{(1)}; \tilde{n}^{(1)} (M M)^b \tilde{n}^{(1)}; \\
& l M (M M)^b n^{(1)}; \tilde{l} M (M M)^b \tilde{n}^{(1)}; n^{(1)} M (M M)^b \tilde{n}^{(2)}; \\
& \tilde{n}^{(1)} M (M M)^b n^{(2)}] + \sum_{c=0}^{\lfloor \frac{N-2}{2} \rfloor} \text{Flip}[n^{(1)} (M M)^c n^{(2)}; \\
& \tilde{n}^{(1)} (M M)^c \tilde{n}^{(2)}; l M (M M)^c \tilde{n}^{(2)}; \tilde{l} M (M M)^c n^{(2)}; \\
& n^{(1)} (M M)^c \tilde{l}; \tilde{n}^{(1)} (M M)^c l; l M (M M)^c \tilde{l}; \\
& n^{(2)} M (M M)^c \tilde{n}^{(2)}] + \sum_{d=0}^{\lfloor \frac{N-1}{2} \rfloor} \text{Flip}[n^{(2)} (M M)^d \tilde{l}; \\
& \tilde{n}^{(2)} (M M)^d l]
\end{aligned}$$

$$\mathcal{W} = 3 \text{Triangles} + \text{Flip}[\tilde{f} \tilde{f}]$$

$$\begin{aligned}
& + \sum_{a=0}^{\lfloor \frac{N-3}{2} \rfloor} \text{Flip}[L^{(2)} (B B)^a L^{(2)}; \\
& L^{(2)} B (B B)^a R] + \\
& \sum_{b=0}^{\lfloor \frac{N-2}{2} \rfloor} \text{Flip}[L^{(1)} (B B)^b L^{(2)}; \\
& L^{(1)} B (B B)^b R] + \\
& \sum_{c=0}^{\lfloor \frac{N-1}{2} \rfloor} \text{Flip}[L^{(1)} (B B)^c L^{(1)}; \\
& R (B B)^c R]
\end{aligned}$$

(4.78)

We claim that ★₁) and ★₂) in (4.78) are dual. For generic N and m , we do not have a proof of this statement. The non-trivial check of the claim is the matching of the central charges.

4.4 Higgsing of $R_{N,k}$

In the last section, we start the study of Higgsing of the $5d$ $R_{N,k}$ theories (4.14).

5d UV duality

Concretely we will study two different Higgsing in $5d$ that is mapped to the same deformation of the $6d$ SCFT. Therefore we are left with another example of $5d$ UV duality. The question that we can ask: does the $5d$ UV duality that we obtain after the Higgsing procedure leads to another $4d$ IR duality? We don't have a general answer to this question but we will study the simplest Higgsing and the answer will turn out to be true. At the level of the brane systems, the Higgsing is manifested by breaking 5-branes on the same 7-brane [183]. The example of Higgsing that we consider is the following. We start with the brane web on the left of Figure 4.5 and force two pairs of 5-branes to end on the same 7-brane. We have the choice to take the two pairs either on the same side of the brane web or the opposite side. We obtain the brane systems of Figure 4.20 and the gauge theories associated are shown in (4.79)-(4.80). The details of this example can be found in [191].

*1)

$$(4.79)$$

*2)

$$(4.80)$$

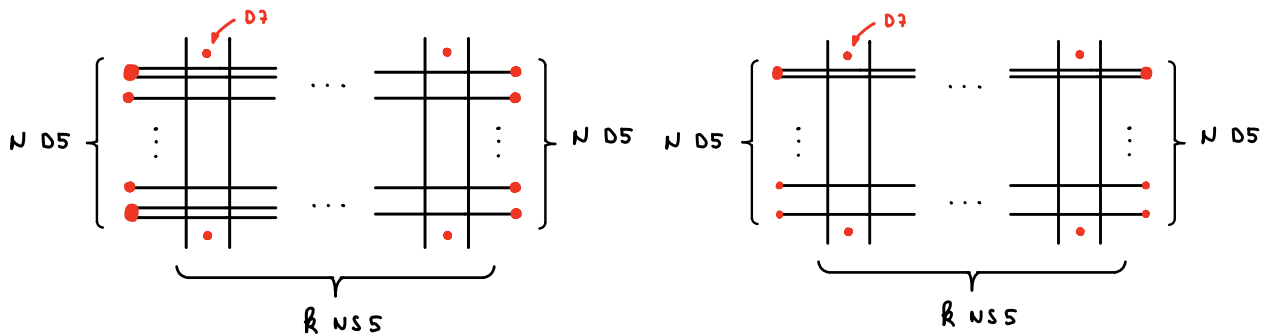

Figure 4.20: Brane setup for (4.79) on the left and for (4.80) on the right.

6d UV completion

The 6d UV completion of the theories (4.79)-(4.80) depends on the parity of k and can be obtained by doing the Higgsing at the level of the Type IIA brane setup corresponding to the 6d UV completion of $R_{N,k}$.

k even: $k = 2l$

In this case, the 6d completion is given by the following Type IIA brane setup [190, 191]:

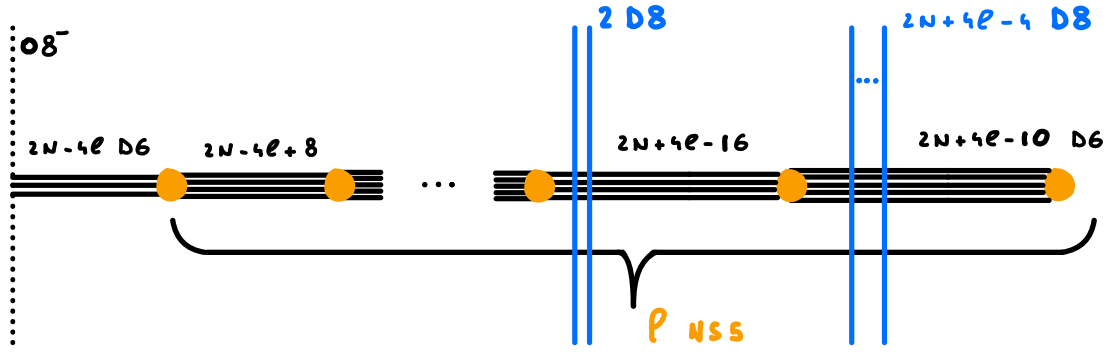
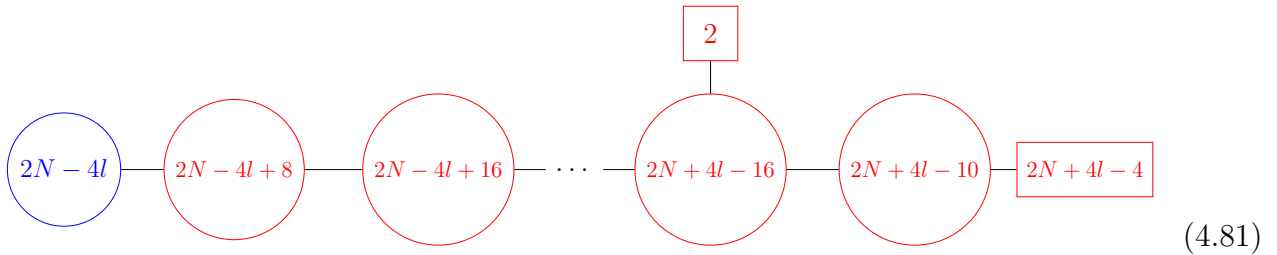

Figure 4.21: Type IIA brane setup corresponding to the 6d UV completion of (4.79)-(4.80) for $k = 2l$. It is obtained by Higgsing the Type IIA brane system (4.10) corresponding to the UV completion of $R_{N,2l}$.

The gauge theory corresponding to this brane system is a linear quiver with one USp gauge node and $l - 1$ SU gauge nodes:



k odd: $k = 2l + 1$

The 6d completion is given by the following Type IIA brane setup [190, 191]:

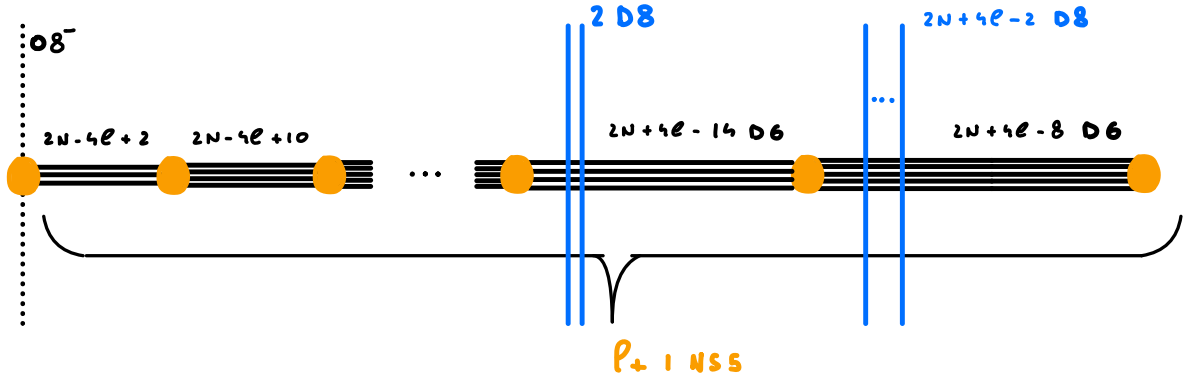
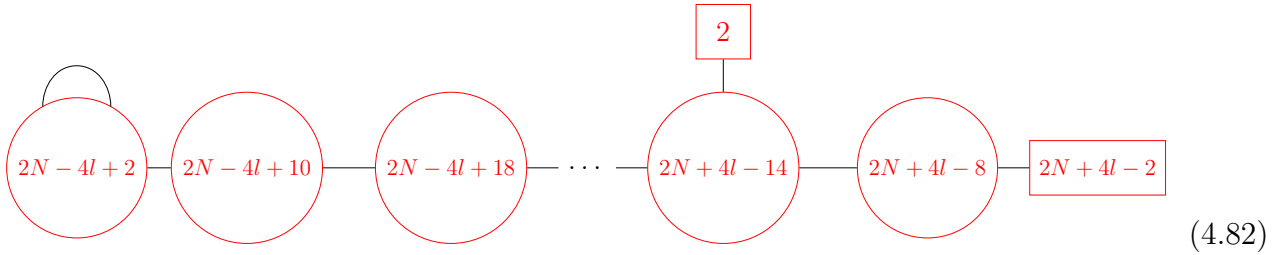

Figure 4.22: Type IIA brane setup corresponding to the $6d$ UV completion of (4.79)-(4.80) for $k = 2l + 1$. It is obtained by Higgsing the Type IIA brane system (4.11) corresponding to the UV completion of $R_{N,2l+1}$.

The gauge theory corresponding to this brane system is a linear quiver with l SU gauge nodes and an antisymmetric hyper attached to the first node:



4d duality

Applying our procedure to the $5d$ UV duality (4.79)-(4.80) we produce the following $4d$ $\mathcal{N} = 1$ theories

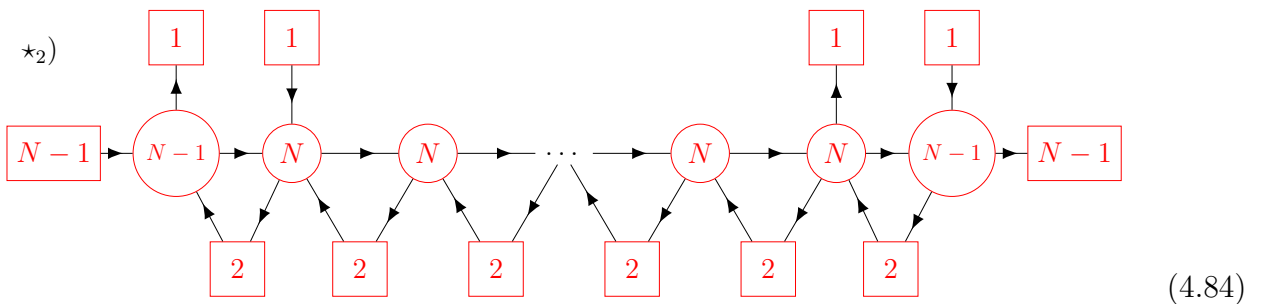
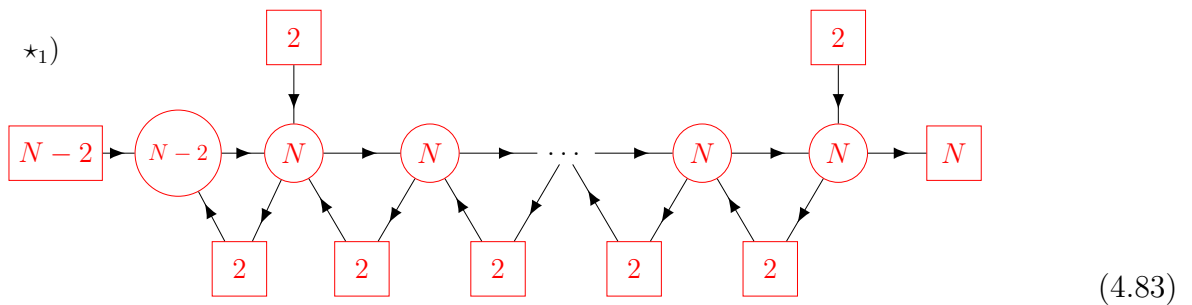

Let us remark that in order to get non-anomalous theories we were forced to split the flavor nodes at the edge of the quiver compared to the 5d avatars.

Proof of the 4d duality

The proof is really similar to the subsection 4.2.2 so we will be brief. Start with \star_1) and do the following operations:

- $k - 1$ Seiberg dualities on the SU nodes from left to right
- CSST duality on the left SU(2)
- $k - 3$ confinements

Then start with \star_2) and do the following operations:

- $k - 1$ Seiberg dualities on the SU nodes from left to right
- CSST duality on the left SU(2)
- $k - 3$ confinements

Finally, we introduce some flippers and both \star_1) and \star_2) take the same following form which proves the duality

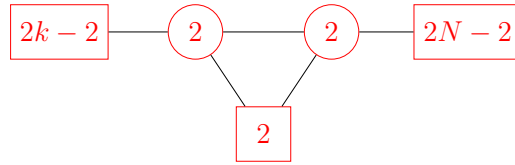

$\mathcal{W} = \text{Triangle}$

(4.85)

4.5 Outlook

In this chapter, we have applied our prescription to known examples of 5d dualities, involving KK-theories, to construct non trivial $4d \mathcal{N} = 1$ dualities. We saw that our prescription produces a non-anomalous $4d \mathcal{N} = 1$ theory only if the ranks of the SU nodes are constant. It would be interesting to generalize it to more general quivers, e.g. unitary tails with non-constant rank or ortho-symplectic quivers present in [190, 193].

We provided a prescription to obtain 4d duality from 5d dualities, but we did not investigate *why* our prescription works, that is why the 5d UV KK duality is transferred to a 4d IR duality. This is obviously an important question, so let us close this outlook with some speculations about a possible explanation. Obviously, it would deserve more investigations.

Possible interpretation

There should be a connection between our prescription and the compactification of $6d$ $(1, 0)$ SCFT's on tubes. Such compactification is usually done in two steps: first, one compactified the $6d$ brane system on a circle, getting a pq-web and the associated infrared $5d$ KK gauge theory (this is exactly what we are doing in this paper). Second, one constructs a $4d$ $\mathcal{N} = 1$ supersymmetric duality wall [111, 170–177, 250–254]. This second step is very similar to our prescription, the difference is that we are adding the triangle terms and we are gauging the $5d$ gauge groups also in $4d$. Gauging such puncture symmetry should be related to gluing the two boundaries of the tube into a torus.

This suggests that our $4d$ gauge theories are related to their *mother* $6d$ SCFT on a Riemann surface with flux, but no punctures (a puncture would reveal itself as some global symmetry descending from a $5d$ gauge symmetry). More precisely, since the rank of the $4d$ global symmetry for our theories is the rank of the $6d$ global symmetry minus one, one can expect them to be a relevant superpotential deformation of the $4d$ SCFTS obtained by $6d$ SCFT on a Riemann surface with flux (which instead have the rank of the $4d$ global symmetry equal to the rank of the $6d$ global symmetry).

Chapter 5

New S-confining theories and supersymmetry enhancement

The content of this Chapter is essentially taken from [4].

5.1 Introduction

This Chapter is divided into two parts. In the first part, we propose new $4d \mathcal{N} = 1$ S-confining theories, with non-zero, cubic, superpotential and a simple gauge group, that can be symplectic, orthogonal or special unitary. The matter content of our gauge theories is given by a rank-two matter field ϕ (which for symplectic, orthogonal or special unitary gauge group sits in the antisymmetric, symmetric and adjoint representation, respectively) and fundamental matter p . The number of fundamental fields is tuned in such a way that the gauge theory is confining. Our examples generalize in particular those of [46], studied in Section 2.8 by having a non-trivial superpotential for these fields. One class of such S-confining dualities has a superpotential of the form ϕpp , and all the fundamentals enter the superpotential. Another class has a superpotential of the form $\phi^3 + \phi pp$, and only a subset of the fundamentals enter the superpotential. Among this second class, the special unitary case is actually not S-confining, but more precisely it has a quantum deformed moduli space, similarly to what happens e.g. for the $SU(2)$ SQCD with four fundamental chirals [37]. Then, we derive some of the previously stated dualities, using deconfinement techniques as in Chapter 3 and/or Kutasov–Schwimmer-like dualities of Section 2.6.2. We provide additional checks of our proposals by matching 't Hooft anomalies. Another important result of this first part is the reduction to $3d$ of one of this new $4d$ S-confining duality. More precisely, using the methods of [94], the reduction of $USp(2n)$ with antisymmetric a and $\mathcal{W} \sim app$ gives the following $3d \mathcal{N} = 2$ S-confining duality:

$$\begin{array}{ccc}
 \begin{array}{c}
 \phi \\
 \circlearrowleft \quad \circlearrowright \\
 n \\
 \begin{array}{c}
 \xrightarrow{q} \\
 \xleftarrow{\tilde{q}}
 \end{array} \\
 \text{[} 2n+1 \text{]}
 \end{array}
 & \iff &
 \begin{array}{c}
 \text{[} 2n+1 \text{]} \\
 \text{[} 2n+1 \text{]} \\
 \text{[} 2n+1 \text{]} \\
 \Phi
 \end{array}
 \end{array}
 \quad (5.1)$$

$\mathcal{W} = \phi q \tilde{q} + \mathfrak{M}^+ + \mathfrak{M}^- \qquad \mathcal{W} = \Phi^3$

On the left hand side of (5.1) the superpotential includes monopole terms, while on the right side it is important that a cubic $SU(2n+1)$ -invariant superpotential is present.

In the second part of the chapter, we use the $3d$ duality (5.1) to explain and generalize the $4d$ susy enhancement recently proposed in [213]. Indeed, [213] provided compelling evidence that an $\mathcal{N} = 1$ $SU(2n+1)$ diagonal gauging of three copies of the $\mathcal{N} = 2$ non-Lagrangian theory $D_2(SU(2n+1))$ [158, 162, 214] flows to the conformal manifold of $4d$ $\mathcal{N} = 4$ SYM with gauge group $SU(2n+1)$. The work [213] was a result of a detailed analysis of the landscape of $4d$ $\mathcal{N} = 1, 2$ theories that have $a = c$ conformal central charges at finite N [255–258]. From their analysis, in particular the matching of anomalies, superconformal indices and certain operators in the spectrum, the intuition that one gets is that each copy of $D_2(SU(2n+1))$ is morally replacing an adjoint chiral in the SYM theory (see also [259]).

We reduce this proposed duality on a circle and use the fact that the $D_2(SU(2n+1))$ theory becomes Lagrangian in $3d$, namely it is the $3d$ $\mathcal{N} = 4$ $U(n)$ SQCD with $2n+1$ flavors [158, 260–262]. Modulo the monopole superpotential, which as we will argue is dynamically generated once we compactify the $4d$ theory on a point of its conformal manifold that breaks all the abelian symmetries, this is the left hand side of (5.1). The $3d$ interpretation is summarized by the following diagram:

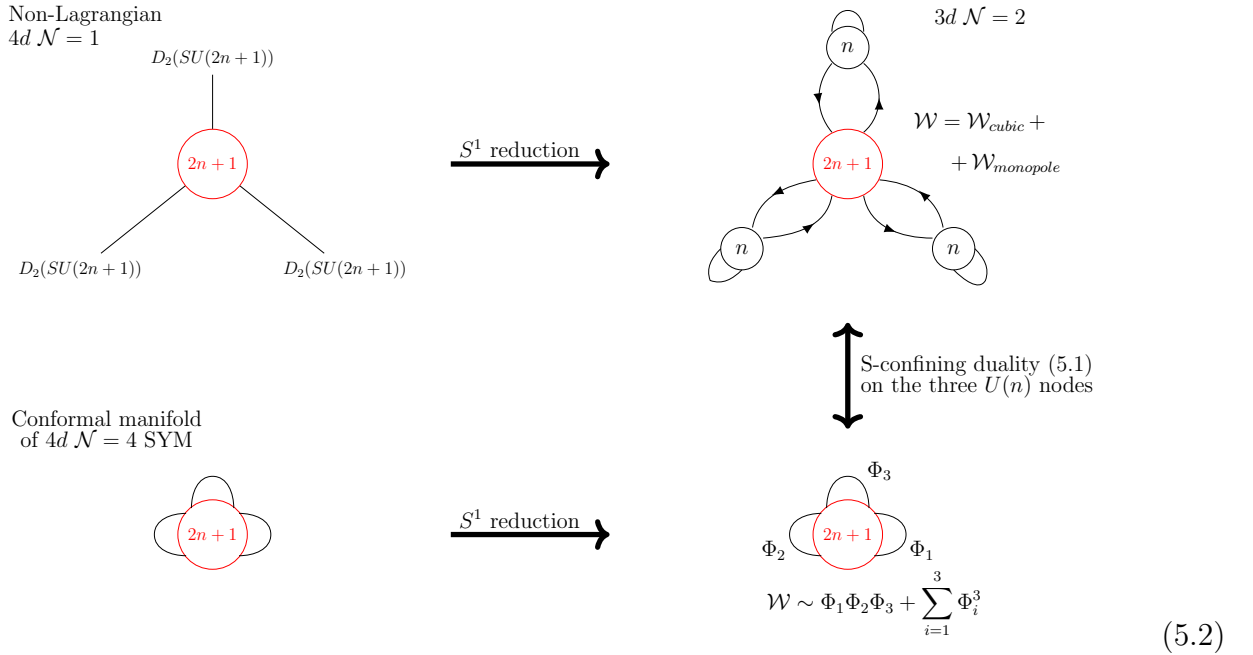

Since the $3d$ reduction of the non-Lagrangian $4d$ $\mathcal{N} = 1$ theory is, thanks to the S-confinement (5.1), dual to the $3d$ reduction of $\mathcal{N} = 4$ SYM, it is natural to expect that also the $4d$ theories on the left side of (5.2) are dual to each other. Notice in particular that the $3d$ S-confining duality confirms the $4d$ intuition that each copy of $D_2(SU(2n+1))$ plays the role of one of the adjoint chirals of $\mathcal{N} = 4$ SYM. We point out that leveraging the S_3 permutation symmetry of the $4d$ non-Lagrangian theory at $\mathcal{W} = 0$, it is possible to determine the R-charges without using a-maximization. Such symmetry also implies that the $4d$ non-Lagrangian theory at $\mathcal{W} = 0$ is dual to a point of the β -deformation [263] line with $\beta = \pi$ in the conformal manifold of $\mathcal{N} = 4$ SYM.

Armed with this $3d$ understanding, we provide a new example of supersymmetry enhancement, which follows a very similar logic. We consider the $4d$ $\mathcal{N} = 2$ non-Lagrangian theory $D_2(SU(6n+3))$ and perform an $\mathcal{N} = 1$ gauging of an $SU(2n+1)^3$ subgroup of the $SU(6n+3)$

global symmetry. We provide strong evidence that this should flow to a point of the conformal manifold of the $4d \mathcal{N} = 2$ necklace quiver theory with three $SU(2n + 1)$ gauge nodes. In this case, the $D_2(SU(6n + 3))$ theory plays the role of the three adjoint and the six bifundamental chirals. These can be understood as coming from the decomposition of the moment map for the $SU(6n + 3)$ global symmetry of $D_2(SU(6n + 3))$ under the gauged subgroup, as it again becomes evident from the $3d$ perspective.

Upon reduction to $3d$, indeed, we get a four node quiver, which after dualizing the middle unitary gauge group with the S-confining duality becomes an $SU(2n + 1)^3$ gauge theory which is precisely the $3d$ reduction of the $4d \mathcal{N} = 2$ necklace quiver with three nodes. The diagram summarizing the duality and the reductions is very similar to (5.2)

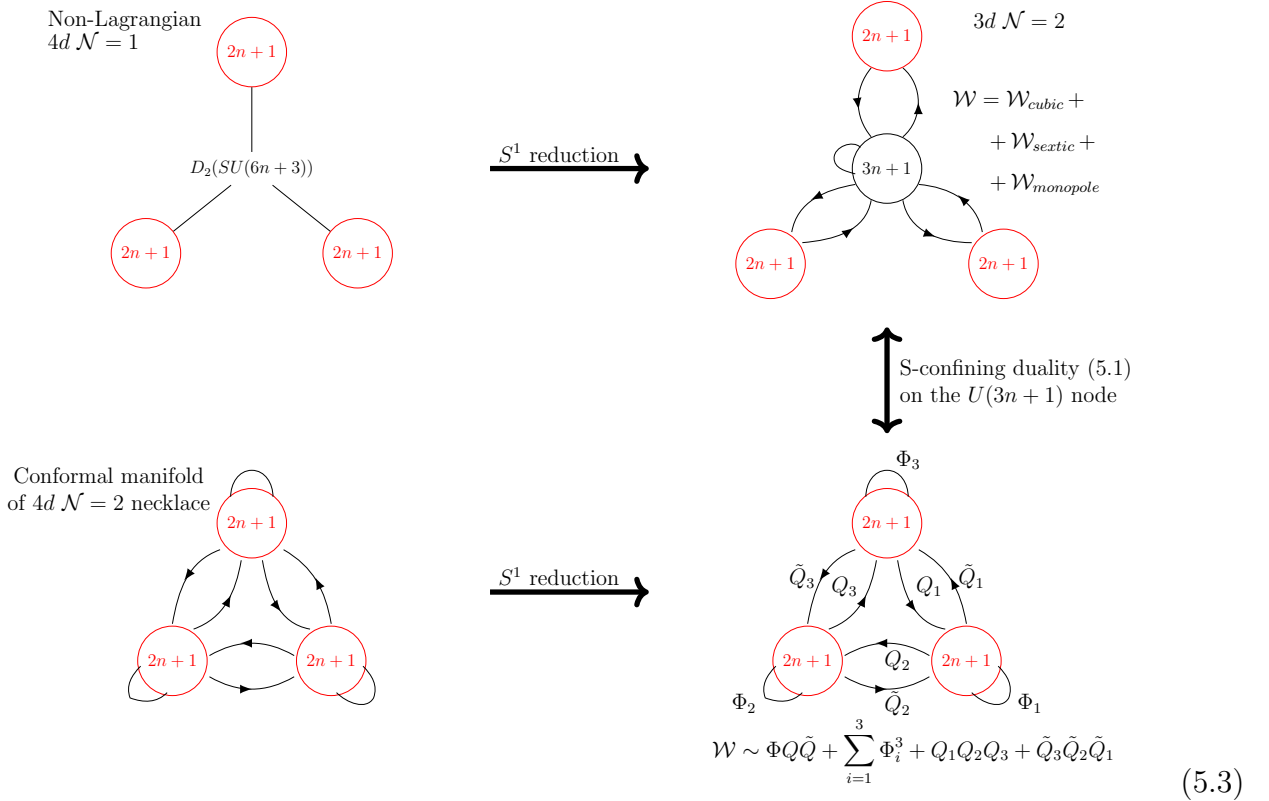

This logic strongly suggests that the $4d \mathcal{N} = 1$ theory in the top left of (5.3) flows to the same conformal manifold of the $4d \mathcal{N} = 2$ theory on the bottom left of (5.3). On top of the $3d$ analysis, we also check this statement by matching anomalies and superconformal indices.

The chapter is organized as follows.

In Section 5.2, we propose the new S-confining theories, with simple gauge group and cubic superpotential. In the case of $USp(2n)$ gauge group and $\mathcal{W} \sim app$, we discuss the reduction on a circle, which upon turning on appropriate real masses, leads to a $3d U(n)$ gauge theory with $2n + 1$ flavors and a monopole superpotential which is dual to an adjoint field Φ with cubic superpotential.

In Section 5.3, we derive some of the previously stated dualities, using deconfinement techniques and/or Kutasov–Schwimmer-like dualities. *Pole pinching* in the superconformal index is also helpful.

In Section 5.4, we turn to the study of various $4d \mathcal{N} = 1$ theories with susy enhancement and

their understanding using the $3d$ S-confining duality upon circle compactification. Specifically, in Subsection 5.4.1 we provide a $3d$ explanation of the susy enhancement of the theory proposed in [213], that is an $\mathcal{N} = 1$ $SU(2n+1)$ gauging of three copies of the $\mathcal{N} = 2$ theory $D_2(SU(2n+1))$ which flows to a point of the conformal manifold of $4d$ $\mathcal{N} = 4$ SYM with gauge group $SU(2n+1)$. Based on the $3d$ understanding of this case, in Subsection 5.4.2 we are then able to generalize it and give as a new example the $\mathcal{N} = 1$ $SU(2n+1)^3$ gauging of a single copy of the $\mathcal{N} = 2$ $D_2(SU(6n+3))$ theory which flows on the conformal manifold of the $4d$ $\mathcal{N} = 2$ necklace quiver with three $SU(2n+1)^3$ gauge group.

In section 5.5, we give an outlook.

5.2 New $4d$ and $3d$ S-confining theories with cubic superpotential

In this section we discuss new S-confining theories by lifting the assumption of zero superpotential of [46]. Here we will only state the results and some of the associated supersymmetric index identities, while in Section 5.3 we will provide a derivation of some of those and in Appendix C.2 we will show additional tests based on anomaly matching for all of them.

5.2.1 Theories with $\mathcal{W} \sim \phi pp$

We start in this subsection by considering the new S-confining dualities where the superpotential is of the form $\mathcal{W} \sim \phi pp$, where ϕ is a generic chiral field in some rank-2 representation of the gauge group.

$USp(2n)$ gauge group: $\mathcal{U}_1[n]$ theories

The first example involves a $USp(2n)$ gauge group¹ with an antisymmetric traceless chiral field a and $4n+2$ chiral fields p in the fundamental representation. We turn on the superpotential²

$$\mathcal{W} = app = a^{il} p_{\alpha}^j p_{\beta}^k J_{ij}^{(2n)} J_{kl}^{(2n)} J_{(4n+2)}^{\alpha\beta}. \quad (5.4)$$

This changes the non-abelian flavor symmetry into $USp(4n+2)$ and breaks one abelian global symmetry, so that the total non-anomalous global symmetry of the theory is

$$USp(4n+2) \times U(1)_R. \quad (5.5)$$

The theory without superpotential and arbitrary number of fundamentals has been studied in Section 3.3.

The Wess–Zumino (WZ) model that describes the IR physics of the gauge theory consists of a field in the antisymmetric traceless representation of the $USp(4n+2)$ flavor symmetry and

¹For most of this section we will only specify the Lie algebras and ignore issues related to the global structure of groups.

²Here $J^{(2n)} = \mathbb{1}_n \otimes i\sigma_2$ is the totally antisymmetric invariant tensor of $USp(2n)$. In the following we will often omit the contraction of indices.

On the gauge theory side, the topological symmetry and the axial symmetry, i.e. the symmetry assigning charge +1 to both q and \tilde{q} and -2 to ϕ , are broken by the monopole superpotential, while as usual the baryonic symmetry acting with charges +1 and -1 on q and \tilde{q} respectively is part of the gauge symmetry. Since there is no abelian symmetry that can mix with the R-symmetry in the IR, the R-charges of the fields can just be determined by imposing that they are compatible with the superpotential. We get the same R-charges as in 4d

$$R[\phi] = \frac{4}{3}, \quad R[q] = R[\tilde{q}] = \frac{1}{3}. \quad (5.15)$$

The operator map works similarly to the original 4d duality, since the monopole superpotential completely lifts the Coulomb branch

$$q\tilde{q} \longleftrightarrow \Phi, \quad (5.16)$$

where the trace part of the meson $q\tilde{q}$ is set to zero by the F-term equation of ϕ .

Similarly to the comment we made at the end of the previous subsection for the $\mathcal{U}_1[n]$ duality, it would be interesting to understand whether this 3d S-confining duality or some other related to it by RG flow can be derived from compactifications of 5d SCFTs on Riemann surfaces with flux, which have been recently investigated in [264–267].

$O(n)$ gauge group: $\mathcal{O}_1[n]$ theories

The second theory is a $O(n)$ gauge theory with a chiral s in the symmetric traceless representation and $2n - 2$ chirals p in the vector representation. We turn on the superpotential⁶

$$\mathcal{W} = spp. \quad (5.17)$$

This changes the non-abelian flavor symmetry into $SO(2n - 2)$ and breaks one abelian global symmetry, so that the total non-anomalous global symmetry of the theory is

$$SO(2n - 2) \times U(1)_R. \quad (5.18)$$

The WZ model that describes the IR physics of the gauge theory consists of a field in the symmetric traceless representation of the $SO(2n - 2)$ flavor symmetry and the trace part⁷. The proposed duality can be summarized by the following quiver:

$$\mathcal{O}_1[n]: \quad \begin{array}{ccc} \begin{array}{c} \text{circle } n \text{ with loop } s, \frac{4}{3} \\ \text{--- } p \text{ ---} \\ \text{square } 2n-2 \\ \text{--- } \frac{1}{3} \end{array} & \iff & \begin{array}{c} \text{square } 2n-2 \text{ with loop } S, \frac{2}{3} \end{array} \\ \mathcal{W} = spp & & \mathcal{W} = S^3 + \text{tr}(S)S^2 \end{array} \quad (5.19)$$

we point out that with this matter content the gauge theory $\mathcal{O}_1[n]$ is IR free. Nevertheless when such a gauge node is part of a bigger quiver, which we may want to dualize with this

⁶The indices are contracted with the totally symmetric invariant tensor $\delta_{ij}^{(n)}$ of $SO(n)$

⁷The trace part is the singlet defined as $\text{tr } S \equiv S^{ij} \delta_{ij}^{(2n-2)}$.

confining duality, the behaviour of the gauge coupling might change and the theory might become asymptotically free.

The combination of the constraint from the vanishing of the $U(1)_R$ ABJ anomaly and the constraint from the superpotential fixes the R-charges of the fields to be

$$R[s] = \frac{4}{3}, \quad R[p] = \frac{1}{3}. \quad (5.20)$$

Another consequence of the superpotential is the truncation of the chiral ring of the theory. The mapping of the chiral ring generators is given by⁸

$$\begin{array}{ccc} pp & \longleftrightarrow & S \\ \text{tr}[pp] & & \text{tr} S \end{array} \quad (5.21)$$

From the operator map we can see that it is crucial to take the gauge group to be $O(n)$ rather than $SO(n)$. Indeed, in the $SO(n)$ gauge theory we would have an additional chiral operator corresponding to the baryon⁹

$$\epsilon_{a_1 \dots a_n} p^{a_1} \dots p^{a_n} \quad (5.22)$$

which would not be mapped under the duality. This operator is charged under the 0-form $\mathbb{Z}_2^{\mathcal{C}}$ charge conjugation symmetry of the $SO(n)$ gauge theory. The $O(n)$ gauge theory is obtained by gauging $\mathbb{Z}_2^{\mathcal{C}}$, which has thus the effect of projecting out the baryonic operator and make the duality consistent.

Let us briefly comment on the structure of higher-form symmetries [268] in this duality. The $O(n)$ gauge theory has a \mathbb{Z}_2 1-form symmetry coming from the center of the $SO(n)$ part that acts trivially on the matter fields. It also has a \mathbb{Z}_2 2-form symmetry that arises from gauging the 0-form $\mathbb{Z}_2^{\mathcal{C}}$ charge conjugation symmetry of the $SO(n)$ gauge theory. None of these symmetries is present on the WZ side. The two possibilities are that either these symmetries end up acting trivially at low energies or in the dual there should also be a topological sector that carries these symmetries. The latter is well-known to occur for example in dualities for $3d \mathcal{N} = 2$ theories, such as the duality appetizer of [110]. The simplest possibility for such a topological theory is a BF theory with action of the form

$$\pi \int_{X_4} \delta A_1 \cup B_2, \quad (5.23)$$

where $A_1 \in C^1(X_4, \mathbb{Z}_2)$ is a dynamical gauge field for a \mathbb{Z}_2 0-form symmetry and $B_2 \in C^2(X_4, \mathbb{Z}_2)$ is a dynamical gauge field for a \mathbb{Z}_2 1-form symmetry. Such a BF theory indeed has both a \mathbb{Z}_2 1-form symmetry whose charged line operators are $\exp(i\pi \int_L A_1)$ and a \mathbb{Z}_2 2-form symmetry whose charged surface operators are $\exp(i\pi \int_S B_2)$. Each of these operators charged under one of the two higher-form symmetries is also the topological operator that generates the other symmetry, where the fact that they are topological is a consequence of

⁸We use the following notation: $\text{tr}[pp] \equiv p_{a_1}^{i_1} p_{a_2}^{i_2} \delta_{(n)}^{a_1 a_2} \delta_{i_1 i_2}^{(2n-2)}$.

⁹The presence of this baryonic operator in the spectrum of the $SO(n)$ gauge theory can be explicitly checked with index computations for low values of n . We have checked that to low orders the index of the $SO(n)$ theory matches that of the WZ theory up to the contribution of the baryon.

the equations of motion, e.g. the e.o.m. of B_2 sets $\delta A_1 = 0$ and viceversa upon integration by parts. Nevertheless, such a topological symmetry cannot be detected with the tools at our disposal, e.g. the anomalies for continuous symmetries and the index, and so we cannot make any conclusive statement about it. It would be interesting to clarify this issue by matching supersymmetric partition functions that are sensitive to such a topological sector.¹⁰

5.2.2 Theories with $\mathcal{W} \sim \phi^3 + \phi qq$

In this subsection, we present other examples of S-confining theories involving matter in a rank-2 representation under the gauge group, but with a different superpotential with respect to the previous examples. Specifically, we will also have a cubic superpotential term ϕ^3 for the rank-2 field ϕ .

$USp(2n)$ gauge group: $\mathcal{U}_2[n, h]$ theories

The first example is a two parameters family. It is the $USp(2n)$ gauge theory with a traceful antisymmetric chiral field a and $2n + 8 - 2h$ fundamental chirals that we split in two groups: $2n + 8 - 4h$, q and $2h$, p . The superpotential is

$$\mathcal{W} = a^3 + aqq + \text{Flip}[pp; app; qp]. \quad (5.24)$$

Notice that we also added flippers that flip some gauge invariant operators involving p . The non-anomalous global symmetry of the theory that is preserved by the superpotential is

$$SU(2h) \times USp(2n + 8 - 4h) \times U(1)_R. \quad (5.25)$$

We claim that in the IR we obtain the trivial theory without any d.o.f.. We summarize this claim by the following quiver

$$\mathcal{U}_2[n, h] : \quad \begin{array}{c} \begin{array}{ccc} \begin{array}{c} a, \frac{2}{3} \\ \textcircled{2n} \end{array} & \begin{array}{c} q \\ \text{---} \\ \textcircled{2n + 8 - 4h} \end{array} & \\ \begin{array}{c} \frac{2}{3} \\ \text{---} \\ \textcircled{2h} \end{array} & & \end{array} \iff \text{Trivial theory} \\ \begin{array}{c} p \\ \text{---} \\ \textcircled{2h} \end{array} \end{array} \quad \begin{array}{c} \frac{h-n}{3h} \\ \text{---} \\ \textcircled{2h} \end{array}$$

$$\mathcal{W} = a^3 + aqq + \text{Flip}[pp; app; qp] \quad (5.26)$$

The range of validity for the parameter h is $0 \leq h < \frac{n}{2} + 2$. h cannot be taken to be $\frac{n}{2} + 2$ because otherwise we cannot turn on the deformation aqq which is crucial.

¹⁰There is also a question of whether the gauge group should be $O(n)$ or $Pin(n)$, both of which have the \mathbb{Z}_2^C charge conjugation symmetry gauged. The difference is that in the former the \mathbb{Z}_2 1-form symmetry is electric, i.e. it comes from its center, while in the latter it is magnetic, i.e. it comes from the center of the dual group. One can move from one variant to the other by gauging these symmetries. If our guess about the presence of the topological sector in the duality is true, then as a consequence of the duality we can deduce that the two variants are actually equivalent, since under the gauging of the 1-form symmetry the topological theory (5.23) gives an identical theory, but expressed in terms of the dual field.

The associated index identity is

$$\begin{aligned}
& \prod_{k<l}^{2h} \Gamma_e \left((pq)^{\frac{2h+n}{3h}} v_k^{-1} v_l^{-1} \right) \Gamma_e \left((pq)^{\frac{h+n}{3h}} v_k^{-1} v_l^{-1} \right) \prod_{i=1}^{n+4-2h} \prod_{l=1}^{2h} \Gamma_e \left((pq)^{\frac{3h+n}{6h}} f_i^{\pm 1} v_l^{-1} \right) \\
& \times \frac{(p; p)_\infty^n (q; q)_\infty^n}{2^n n!} \oint \prod_{a=1}^n \frac{dz_a}{2\pi i z_a} \frac{\prod_{a=1}^n \prod_{i=1}^{n+4-2h} \Gamma_e \left((pq)^{\frac{1}{6}} z_a^{\pm 1} f_i^{\pm 1} \right) \prod_{l=1}^{2h} \Gamma_e \left((pq)^{\frac{h-n}{6h}} z_a^{\pm 1} v_l \right)}{\prod_{a=1}^n \Gamma_e(z_a^{\pm 2}) \prod_{a<b}^n \Gamma_e(z_a^{\pm 1} z_b^{\pm 1})} \\
& \times \Gamma_e \left((pq)^{\frac{1}{3}} \right)^n \prod_{a<b}^n \Gamma_e \left((pq)^{\frac{1}{3}} z_a^{\pm 1} z_b^{\pm 1} \right) = 1, \tag{5.27}
\end{aligned}$$

where f_i for $i = 1, \dots, n+4-2h$ are the $USp(2n+8-4h)$ fugacities while v_l for $l = 1, \dots, 2h$ with $\prod_l v_l = 1$ are the $SU(2h)$ fugacities.

We show the matching of anomalies for this duality in Appendix C.2, while in Subsection 5.3.1 we will derive it by iterative applications of more elementary dualities.

We can formulate the duality in a little bit more general form where on the r.h.s. we don't have a trivial theory. In order to do this, we have to flip on the l.h.s. mesons involving the field q . For generic n and h , the only meson that we can flip is qq . The reason is because the R-charge of the field p becomes quickly very negative. Therefore, the meson built from this field p will map to a fundamental field in the WZ with large negative R-charge and it becomes impossible to write down a superpotential. When we flip only qq we get on the dual frame a field A in the traceful antisymmetric representation of $USp(2n+8-4h)$:

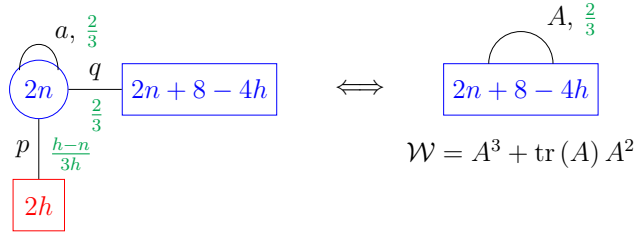

$$\mathcal{W} = a^3 + aqq + \text{Flip}[pp; app; qp; qq] \tag{5.28}$$

The mapping is the following:

$$\text{Flipper}[qq] \longleftrightarrow A \tag{5.29}$$

Special case of $h = 1$. In this case, we can write the duality in yet another equivalent form with more fields on the r.h.s.. We obtain it by splitting the fundamental of $SU(2h) = SU(2)$, p into two independent fields p_1 and p_2 . The duality is the following:

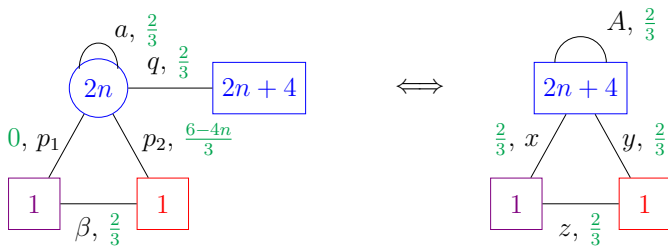

$$\begin{aligned}
\mathcal{W} &= a^3 + aqq + \text{Flip}[p_1 p_2; ap_1 p_2; qp_2; ap_1 q; qq] \\
&+ \beta \text{Flipper}[ap_1 p_2] p_1 p_2 + \beta \text{Flipper}[ap_1 q] p_1 q \tag{5.30}
\end{aligned}$$

The mapping is the following:

$$\begin{array}{ccc}
\text{Flipper}[q q] & & A \\
p_1 q & \longleftrightarrow & x \\
\text{Flipper}[ap_1 q] & & y \\
\beta & & z
\end{array} \tag{5.31}$$

We specified this duality because we will use this version in Subsection 5.3.3 in the derivation of the dual of $\mathcal{U}_1[n]$.

$SO(n)$ gauge group: $\mathcal{S}_2[n, h]$ theories

The second example consists again of a two parameters family, but this time we have the $SO(n)$ gauge theory with a traceful symmetric chiral field s and $n - 8 - h$ chirals in the vector representation splitted in $n - 8 - 2h$, q and h , p . The superpotential is the same as in the previous subsection, but in this case the non-anomalous global symmetry is

$$SU(h) \times SO(n - 8 - 2h) \times U(1)_R. \tag{5.32}$$

We claim that in the IR this theory flows to a trivial theory without any d.o.f.

$$\begin{array}{c}
\mathcal{S}_2[n, h] : \\
\begin{array}{ccc}
\begin{array}{c}
\text{--- } s, \frac{2}{3} \text{ ---} \\
\text{--- } q \text{ ---} \\
\text{--- } \frac{2}{3} \text{ ---} \\
\text{--- } p \text{ ---} \\
\text{--- } \frac{h-n}{3h} \text{ ---} \\
\text{--- } h \text{ ---}
\end{array}
&
\begin{array}{c}
\text{--- } n \text{ ---} \\
\text{--- } n - 8 - 2h \text{ ---} \\
\text{--- } h \text{ ---}
\end{array}
&
\longleftrightarrow \text{ Trivial theory}
\end{array} \\
\mathcal{W} = s^3 + sqq + \text{Flip}[pp; spp; qp]
\end{array} \tag{5.33}$$

The range of validity for the parameter h is $0 \leq h < \frac{n}{2} - 4$. h cannot be taken to be $\frac{n}{2} - 4$ because otherwise we cannot turn on the deformation sqq which is crucial.

We show the matching of anomalies for this duality in Appendix C.2.

$SU(n)$ gauge group: $\mathcal{A}_2[n, h]$ theories

The last example is the $SU(n)$ gauge theory with a field ϕ in the adjoint plus the singlet trace and two sets of flavors, one of $n - 2h$ flavors q, \tilde{q} and a second of h flavors p, \tilde{p} . The superpotential is

$$\mathcal{W} = \phi^3 + \phi q \tilde{q} + \text{Flip}[p \tilde{p}; \phi p \tilde{p}; q \tilde{p}; \tilde{p} q]. \tag{5.34}$$

The non-anomalous global symmetry of the theory that is preserved by the superpotential is

$$SU(h) \times SU(h) \times SU(n - 2h) \times U(1)_b \times U(1)_s \times U(1)_R, \tag{5.35}$$

where $U(1)_b$ acts with charges ± 1 on q, \tilde{q} and $U(1)_s$ acts with charges ± 1 on p, \tilde{p} .

We claim that the IR of this theory is not trivial but is given by 3 singlets, two of R-charge equal to 0 and one of R-charge 2. The quiver summarizing this claim is the following:

$$\begin{aligned}
& \mathcal{A}_2[n, h] : \quad \begin{array}{c} \phi, \frac{2}{3} \\ \circlearrowleft \\ \text{\color{red}n} \\ \begin{array}{l} \xrightarrow{\tilde{q}} \text{\color{red}n-2h} \\ \xrightarrow{q, \frac{2}{3}} \\ \begin{array}{l} \xleftarrow{p, \frac{h-n}{3h}} \text{\color{red}h} \\ \xleftarrow{\tilde{p}} \text{\color{red}h} \end{array} \end{array} \end{array} \quad \iff \quad \begin{array}{l} \text{3 singlets with superpotential:} \\ \mathcal{W} = N(B\tilde{B} + 1) \end{array} \\
& \mathcal{W} = \phi^3 + \phi q \tilde{q} + \text{Flip}[p\tilde{p}; \phi p \tilde{p}; p\tilde{q}; \tilde{p}q] \quad (5.36)
\end{aligned}$$

The range of validity for the parameter h is $0 \leq h < \frac{n}{2}$. h cannot be taken to be $\frac{n}{2}$ because otherwise we cannot turn on the deformation $\phi q \tilde{q}$ which is crucial.

In order to understand better the physical implications of this result, it is useful to look at the operator map

$$\begin{aligned}
& \text{tr}[p^h \phi^{n-h}] \quad \longleftrightarrow \quad B \\
& \text{tr}[\tilde{p}^h \phi^{n-h}] \quad \longleftrightarrow \quad \tilde{B} \quad (5.37)
\end{aligned}$$

where the flavor indices are contracted with the h -dimensional ϵ tensor so that the operator is a flavor singlet. The singlet N instead is not in the chiral ring since it is turned on in the superpotential, but it is associated with the superpotential term $\phi q \tilde{q}$ on the l.h.s. as it can be understood from the derivation of this result that we give in Subsection 5.3.2.

If we focus now on the r.h.s., we can understand the singlet N of R-charge 2 as the analogue of the Lagrange multiplier that appears in the $SU(n)$ SQCD with n flavors [37]. Indeed, its e.o.m. forces B and \tilde{B} to have a non-vanishing vev and the theory has thus a quantum deformed moduli space of vacua. Remembering the operator map above, our result is then telling us that the theory on the l.h.s. has a quantum deformed moduli space of vacua with a spontaneous breaking of the $U(1)_s$ symmetry, due to the fact that the operators $\text{tr}[p^h \phi^{n-h}]$ and $\text{tr}[\tilde{p}^h \phi^{n-h}]$ acquire a vev quantum mechanically triggered by the deformation $\phi q \tilde{q}$, while all the other operators trivialize at low energies.

At the level of the supersymmetric index, this duality translates into the following non-trivial integral identity:

$$\begin{aligned}
& \prod_{k,l=1}^h \Gamma_e \left((pq)^{\frac{2h+n}{3h}} v_k w_l^{-1} \right) \Gamma_e \left((pq)^{\frac{h+n}{3h}} v_k w_l^{-1} \right) \\
& \times \prod_{i=1}^{n-2h} \prod_{l=1}^h \Gamma_e \left((pq)^{\frac{3h+n}{6h}} b s^{-1} f_i^{-1} v_l \right) \Gamma_e \left((pq)^{\frac{3h+n}{6h}} b^{-1} s f_i w_l^{-1} \right) \\
& \times \frac{(p; p)_\infty^n (q; q)_\infty^n}{n!} \oint \prod_{a=1}^n \frac{dz_a}{2\pi i z_a} \frac{\prod_{a,b=1}^n \Gamma_e \left((pq)^{\frac{2}{3}} z_a z_b^{-1} \right)}{\prod_{a \neq b} \Gamma_e \left(z_a z_b^{-1} \right)} \\
& \times \prod_{a=1}^n \prod_{i=1}^{n-2h} \Gamma_e \left((pq)^{\frac{1}{3}} (b z_a f_i^{-1})^{\pm 1} \right) \prod_{l=1}^h \Gamma_e \left((pq)^{\frac{h-n}{6h}} s z_a v_l^{-1} \right) \Gamma_e \left((pq)^{\frac{h-n}{6h}} s^{-1} z_a^{-1} w_l \right) \\
& = \frac{2\pi i}{(p; p)_\infty (q; q)_\infty} \delta(s^h - 1), \quad (5.38)
\end{aligned}$$

where f_i for $i = 1, \dots, n - 2h$ with $\prod_i f_i = 1$ are the $SU(n - 2h)$ flavor fugacities, while v_l, w_l for $l = 1, \dots, h$ with $\prod_l v_l = \prod_l w_l = 1$ are the fugacities for the two $SU(h)$ symmetries. The singular behaviour of the index is typical of theories with a quantum deformed moduli space of vacua, as discussed in [48, 269]. It can be understood as a singular limit of the index of the three chirals N, B, \tilde{B} interacting with a cubic superpotential when the linear term in N is turned on

$$\lim_{\epsilon \rightarrow 1} \underbrace{\Gamma_e(pq\epsilon^2)}_N \underbrace{\Gamma_e(\epsilon^{-1}s^h)}_B \underbrace{\Gamma_e(\epsilon s^{-h})}_{\tilde{B}} = \frac{2\pi i}{(p; p)_\infty (q; q)_\infty} \delta(s^h - 1). \quad (5.39)$$

5.3 Derivation of the S-confining dualities

In this Section we provide a derivation of the dualities for the theories $\mathcal{U}_1[n]$ and $\mathcal{U}_2[n, h]$ with symplectic gauge group by combining the study of various Higgs mechanisms and the deconfinement technique. The proof that we will give for $\mathcal{U}_2[n, h]$ ¹¹ is also working both for $\mathcal{S}_2[n, h]$ and $\mathcal{A}_2[n, h]$. However the proof for $\mathcal{U}_1[n]$ does not generalize to $\mathcal{O}_1[n]$.

5.3.1 Derivation of $\mathcal{U}_2[n, h]$

We will start from the duality $\mathcal{U}_2[n, h]$ (5.26), since we will then use it in the derivation of $\mathcal{U}_1[n]$. We will first show how this can be understood as a consequence of the duality (2.91) proposed by Intriligator in [53], which generalizes the Kutasov–Schwimmer duality [54, 55] to the case of symplectic gauge group and so in the following we will refer to it as “symplectic KS duality”. Then we will show how for the case $h = 1$ the same result can be obtained by studying the Higgsing due to a vev for some operator, which we do at the level of the supersymmetric index.

Higgsing via symplectic KS duality. We first show how to derive the $\mathcal{U}_2[n, h]$ duality (5.26) for generic n and h from the symplectic KS duality of [53], whose statement we recall in (2.91). Applying it to our case, we obtain the following:

$$\mathcal{W} = a^3 \quad \longleftrightarrow \quad \mathcal{W} = A^3 + \text{Flip}[PP; QQ; PQ; PAP; QAQ; PAQ] \quad (5.40)$$

Here we consider the antisymmetric fields on both sides to be traceful, with the trace parts being mapped to each other under the duality.

Now we deform this duality by the superpotential term aqg and some flippers on the l.h.s.. Following the mapping of the KS duality shown in (2.92), the term aqg is mapped to the term

¹¹We will use an abuse of language by calling the duality statement in the same way as the original theory.

Flipper[QQ]. We also use the mapping to understand the flipping terms. We obtain:

$$\begin{aligned}
\mathcal{W} &= a^3 + aqq + \text{Flip}[pp; app; pq] \\
\mathcal{W} &= A^3 + \text{Flip}[PP; QQ; PQ; PAP; QAQ; PAQ] \\
&\quad + \text{Flipper}[QQ] + \text{Flip}[\text{Flipper}[PAP]; \text{Flipper}[PP]; \text{Flipper}[PAQ]] \quad (5.41)
\end{aligned}$$

We see that a lot of flippers get a mass. After integrating out the massive ones and naming the others, we get

$$\mathcal{W} = A^3 + \eta_{QQ} + \eta_{QQ}QQ + \eta_{PQ}PQ + \eta_{QAQ}QAQ \quad (5.42)$$

At this point we notice that the e.o.m. of the flipper η_{QQ} implies that the operator QQ takes a vev which initiates an Higgsing of the gauge group. In the color-flavor space the field Q can be taken to be diagonal

$$Q_\alpha^I = \begin{pmatrix} \lambda_1 & & \\ & \ddots & \\ & & \lambda_{n+4-2h} \end{pmatrix} \otimes i\sigma_2 \quad (5.43)$$

Due to the e.o.m. of the flipper η_{QQ} , the operator QQ satisfies

$$QQ \equiv Q_\alpha^I Q_\beta^J J_{Gauge}^{\alpha\beta} = -J_{Flav} (\equiv -\mathbf{1}_{n+4-2h} \otimes i\sigma_2) \quad (5.44)$$

Using the presentation (5.43) for Q , the equation (5.44) becomes

$$\begin{pmatrix} \lambda_1^2 & & \\ & \ddots & \\ & & \lambda_{n+4-2h}^2 \end{pmatrix} \otimes i\sigma_2 = \mathbf{1}_{n+4-2h} \otimes i\sigma_2 \quad (5.45)$$

We obtain that the field Q takes the following vev:

$$Q = \mathbf{1}_{n+4-2h} \otimes i\sigma_2 \quad (5.46)$$

The conclusion of this vev is that the $USp(2n+8-4h)$ gauge group and the $USp(2n+8-4h)$ flavor group are broken to the diagonal $USp(2n+8-4h)$ flavor group. It is the mechanism of

color-flavor locking. If we forget for a moment the two flippers η_{PQ} and η_{QAQ} , we would say that the result of the Higgsing is the following:

$$\mathcal{W} = A^3 + \eta_{QQ} + \eta_{QQ}QQ \qquad \mathcal{W} = A^3 \qquad (5.47)$$

The fields on the r.h.s. are obtained as follows. The field Q gets a vev so it disappears as well as the flipper η_{QQ} . The fields A and P are instead unaffected and transform under the remaining $USp(2n+8-4h)$ flavor symmetry.

Starting from the result (5.47), we can go back to (5.42) and study the effect of adding the two flippers η_{PQ} and η_{QAQ} . Once we plug the vev of Q (5.46) in the term $\eta_{PQ}PQ$, it becomes a mass term and then both P and η_{PQ} are integrated out. Similarly, $\eta_{QAQ}QAQ$ becomes a mass term and both A and η_{QAQ} disappear¹². On the dual side, since A and P disappeared, we are left with no d.o.f. and we obtain a trivial theory as claimed in (5.26).

This proof using the KS duality can be applied in the same way in the case of the SO duality (5.33). The specific form of the KS duality is recalled in (2.93). The SU duality (5.36) can also be obtain in a very similar way but there is a little difference that we are going to explain in the next subsection.

Higgsing via the index. For the special case of $h = 1$ we can also derive the $\mathcal{U}_2[n, h = 1]$ duality by directly studying a Higgsing that is triggered by a vev for a specific operator, without having to apply any other more fundamental duality. We point out that the duality $\mathcal{U}_2[n, h = 1]$ is the one we will need to derive the duality $\mathcal{U}_1[n]$, as we will explain in the Subsection 5.3.3.

In order to understand which operator is taking a vev and study the associated Higgs mechanism, it is more convenient to use the perspective of the index, which for the theory $\mathcal{U}_2[n, h = 1]$ is given on the l.h.s. of (5.27) with $h = 1$

$$\begin{aligned} & \Gamma_e \left((pq)^{\frac{n+2}{3}} \right) \Gamma_e \left((pq)^{\frac{n+1}{3}} \right) \Gamma_e \left((pq)^{\frac{n+3}{6}} \right) \frac{(p; p)_\infty^n (q; q)_\infty^n}{2^n n!} \\ & \times \oint \prod_{a=1}^n \frac{dz_a}{2\pi i z_a} \frac{\prod_{a=1}^n \prod_{i=1}^{n+2} \Gamma_e \left((pq)^{\frac{1}{6}} z_a^{\pm 1} f_i^{\pm 1} \right) \Gamma_e \left((pq)^{\frac{1-n}{6}} z_a^{\pm 1} v^{\pm 1} \right)}{\prod_{a=1}^n \Gamma_e(z_a^{\pm 2}) \prod_{a < b}^n \Gamma_e(z_a^{\pm 1} z_b^{\pm 1})} \\ & \times \Gamma_e \left((pq)^{\frac{1}{3}} \right)^{n-1} \prod_{a < b}^n \Gamma_e \left((pq)^{\frac{1}{3}} z_a^{\pm 1} z_b^{\pm 1} \right). \end{aligned} \qquad (5.48)$$

¹²Here the assumption of the antisymmetric to be traceful is important. Indeed if A is traceless, the trace part of the flipper η_{QAQ} would not receive a mass and would stay in the IR.

Let us focus on the following combination of Gamma functions:

$$\Gamma_e \left((pq)^{\frac{1-n}{6}} z_1^{-1} v \right) \prod_{a=1}^{n-1} \Gamma_e \left((pq)^{\frac{1}{3}} z_a z_{a+1}^{-1} \right) \Gamma_e \left((pq)^{\frac{1-n}{6}} z_n v^{-1} \right). \quad (5.49)$$

These provide the following sets of poles:

$$\begin{aligned} z_1 &= v(pq)^{\frac{1-n}{6}} p^{k_1} q^{l_1}, \\ z_{a+1} &= z_a (pq)^{\frac{1}{3}} p^{k_{a+1}} q^{l_{a+1}}, \quad a = 1, \dots, n-1, \\ z_n &= v(pq)^{\frac{n-1}{6}} p^{-k_{n+1}} q^{-l_{n+1}}, \end{aligned} \quad (5.50)$$

where $k_a, l_a = 0, \dots, \infty$ for $a = 1, \dots, n+1$. These collide so to pinch the n -dimensional integration contour at the points corresponding to $k_a = l_a = 0$ (for more details about this type of pinching see [270])

$$\begin{aligned} z_1 &= v(pq)^{\frac{1-n}{6}}, \\ z_2 &= z_1 (pq)^{\frac{1}{3}} = v(pq)^{\frac{3-n}{6}}, \\ &\dots \\ z_{n-1} &= z_{n-2} (pq)^{\frac{1}{3}} = v(pq)^{\frac{n-3}{6}}, \\ z_n &= z_{n-1} (pq)^{\frac{1}{3}} = v(pq)^{\frac{n-1}{6}}. \end{aligned} \quad (5.51)$$

Following [271], the interpretation of this pinching is that there is an operator that is taking a vev. Specifically, such operator is the one constructed from the chirals whose index contribution is (5.49) (this type of vev has been studied also in [50, 270])

$$\langle \text{tr} [a^{n-1} p^2] \rangle \neq 0. \quad (5.52)$$

Notice indeed that this operator has zero R-charge and it is also uncharged under any global symmetry, which is consistent with it getting a vev. The prescription of [271] is to then take the residue at the points (5.51), which implements at the level of the index the Higgs mechanism triggered by such a vev. Observe that in this way we completely get rid of the n -dimensional integral, which means that the gauge group is Higgsed completely by the vev. Evaluating the residue we can figure out what massless fields survive at the end of the Higgsing and we find in this case that there are none, which is compatible with our claim that the theory flows to a trivial theory.

5.3.2 Derivation of $\mathcal{A}_2[n, h]$

Higgsing via KS duality. The derivation is similar to the symplectic case so we will be brief and just highlight the key differences. We start by using the KS duality (2.89) deformed

by the cubic superpotential $\phi q \tilde{q}$. We get the following duality:

$\mathcal{A}_2[n, h] :$

\iff

$$\mathcal{W} = \phi^3 + \phi q \tilde{q} + \text{Flip}[p\tilde{p}; \phi p\tilde{p}; p\tilde{q}; \tilde{p}q] \quad \mathcal{W} = \Phi^3 + \eta_{Q\tilde{Q}} + \eta_{Q\tilde{Q}} Q\tilde{Q} + \text{Flip}[\Phi Q\tilde{Q}; P\tilde{Q}; \tilde{P}Q] \quad (5.53)$$

On the r.h.s., we have named the Flipper $[Q\tilde{Q}]$ as $\eta_{Q\tilde{Q}}$, while we didn't give a name to the other flippers.

Now, as in the USp case, the e.o.m. of $\eta_{Q\tilde{Q}}$ gives a vev to Q and \tilde{Q} equal to the identity. This vev triggers the color-flavor locking mechanism. The $SU(n-2h)$ gauge group and the $SU(n-2h)$ flavor group are broken to the diagonal $SU(n-2h)$ flavor symmetry. In terms of this diagonal symmetry, the fields Q , \tilde{Q} and $\eta_{Q\tilde{Q}}$ decompose as adjoint plus singlet (each field has $(n-2h)^2$ d.o.f.'s), so we have 3 adjoints and 3 singlets. We denote the singlets by B, \tilde{B} and N , respectively. In the Higgsing one adjoint recombines with the broken generators of the gauge group, while the other two become massive. On the other hand, the 3 singlets (B, \tilde{B} have R-charge 0 and N has R-charge 2) survive the Higgsing¹³.

We are interested in $\mathcal{A}_2[n, h]$, where there are additional flippers with respect to (5.53). In $\mathcal{A}_2[n, h]$, after the KS duality and the Higgsing, the fields P, \tilde{P} combine with the flippers of $P\tilde{Q}, \tilde{P}Q$ and become massive, hence disappearing in the IR. The field Φ combines with the flipper of $\Phi Q\tilde{Q}$ and become massive (the adjoint field Φ is traceful, hence all of the components of the Flipper $[\Phi Q\tilde{Q}]$ become massive).

To summarize, $\mathcal{A}_2[n, h]$ is dual to a theory of 3 singlets, two of R-charge 0 (B and \tilde{B} , coming from Q and \tilde{Q}) and one of R-charge 2 (N , coming from $\eta_{Q\tilde{Q}}$). From the superpotential $\text{tr}(\eta_{Q\tilde{Q}}) + \text{tr}(\eta_{Q\tilde{Q}} Q\tilde{Q})$ in the KS dual, after the Higgsing only the following superpotential survives:

$$\mathcal{W} = N + N B \tilde{B} \quad (5.54)$$

This is precisely the claim of (5.36).

5.3.3 Derivation of $\mathcal{U}_1[n]$

In this subsection, we show how to obtain the $\mathcal{U}_1[n]$ duality of (5.6)¹⁴. We use a combination of the deconfinement technique, the iteration of more fundamental dualities and a recursive argument. Indeed from now on, we assume that the duality $\mathcal{U}_1[n-1]$ is correct and we want to obtain the statement for $\mathcal{U}_1[n]$.

The first step is the splitting of the flavors into $4n+1+1$ fundamentals. Of course this step doesn't change anything but it is the correct form to apply the deconfinement of Section

¹³This is the main difference with respect to the USp case, where only two singlets are produced, and they give a mass to each other, disappearing in the IR.

¹⁴We assume that $n \geq 3$, the $n=2$ case is a bit different and is done in the Appendix D.

2.9. We get

$$\begin{aligned}
 \mathcal{U}_1[n] : & \quad \begin{array}{c} \text{Diagram 1: } \text{Node } 2n \text{ (circle) with a loop labeled } a, \frac{4}{3} \text{ and a link } p \text{ to node } 4n+2 \text{ (square).} \\ \text{Link } p \text{ has weight } \frac{1}{3}. \\ \mathcal{W} = app \end{array} & \equiv & \begin{array}{c} \text{Diagram 2: } \text{Node } 2n \text{ (circle) with a loop labeled } a, \frac{4}{3} \text{ and a link } q \text{ to node } 4n \text{ (square).} \\ \text{Link } q \text{ has weight } \frac{1}{3}. \\ \text{Node } 2n \text{ is also connected to two nodes } 1 \text{ (squares) via links } p_1 \text{ and } p_2 \text{ with weight } \frac{1}{3}. \\ \mathcal{W} = aqq + ap_1p_2 \end{array} \\
 & & & (5.55)
 \end{aligned}$$

Now we can deconfine the antisymmetric traceless field a . We obtain

$$\begin{aligned}
 & \quad \begin{array}{c} \text{Diagram: } \text{Node } 2n-2 \text{ (circle) with a loop labeled } b, \frac{2}{3} \text{ and a link } q \text{ to node } 4n \text{ (square).} \\ \text{Link } q \text{ has weight } \frac{1}{3}. \\ \text{Node } 2n-2 \text{ is connected to node } 1 \text{ (square) via link } v \text{ with weight } -\frac{1}{3}. \\ \text{Node } 2n-2 \text{ is connected to node } 1 \text{ (square) via link } d \text{ with weight } \frac{4n-3}{3}. \\ \text{Node } 2n \text{ (circle) is connected to node } 1 \text{ (square) via link } e \text{ with weight } \frac{7-4n}{3}. \\ \text{Node } 2n \text{ is also connected to node } 1 \text{ (square) via link } p_2 \text{ with weight } \frac{1}{3}. \\ \mathcal{W} = bqqb + vb^3p_2 + bde + \text{Flip}[vd; bb] \end{array} \\
 & & & (5.56)
 \end{aligned}$$

At this stage, the $USp(2n)$ gauge group is coupled only to fields in the fundamental representation. We can therefore apply the IP duality (2.86) to it. After the dualization, the term $bqqb$ becomes a mass term and then no link is created between the $USp(2n-2)$ gauge node and the $USp(4n-4)$ flavor node. The term bde becomes a mass term for the field d . After integrating it out, we obtain

$$\begin{aligned}
 & \quad \begin{array}{c} \text{Diagram: } \text{Node } 2n-2 \text{ (circle) with a loop labeled } A \text{ with weight } \frac{4}{3} \text{ and a link } B \text{ to node } 4n-4 \text{ (circle).} \\ \text{Link } B \text{ has weight } \frac{1}{3}. \\ \text{Node } 2n-2 \text{ is connected to node } 1 \text{ (square) via link } v \text{ with weight } -\frac{1}{3}. \\ \text{Node } 2n-2 \text{ is connected to node } 1 \text{ (square) via link } R \text{ with weight } 1. \\ \text{Node } 4n-4 \text{ (circle) is connected to node } 1 \text{ (square) via link } P \text{ with weight } \frac{2}{3}. \\ \text{Node } 4n-4 \text{ is also connected to node } 1 \text{ (square) via link } E \text{ with weight } \frac{6-4n}{3}. \\ \text{Node } 4n-4 \text{ is connected to node } 4n \text{ (square) via link } Q \text{ with weight } \frac{2}{3}. \\ \mathcal{W} = BQQB + ABB + vAR + BRP + \text{Flip}[vBE; QQ; PE; EQ; PQ] \end{array} \\
 & & & (5.57)
 \end{aligned}$$

Here the antisymmetric field A is traceless because the trace part has been killed by the superpotential term $\text{Flip}[bb]$.

We can now use our recursive hypothesis. In the splitted form, the statement of the $\mathcal{U}_1[n-1]$ duality is the following:

$$\begin{aligned}
 & \quad \begin{array}{c} \text{Diagram 1: } \text{Node } 2n-2 \text{ (circle) with a loop labeled } A \text{ and a link } B \text{ to node } 4n-4 \text{ (square).} \\ \text{Link } B \text{ has weight } \frac{1}{3}. \\ \text{Node } 2n-2 \text{ is connected to node } 1 \text{ (square) via link } v \text{ and to node } 1 \text{ (square) via link } R. \\ \mathcal{W} = ABB + vAR \end{array} & \iff & \begin{array}{c} \text{Diagram 2: } \text{Node } 4n-4 \text{ (square) with a loop labeled } B. \\ \text{Node } 4n-4 \text{ is connected to node } 1 \text{ (square) via link } X \text{ and to node } 1 \text{ (square) via link } Y. \\ \text{Node } 1 \text{ (square) is connected to node } 1 \text{ (square) via link } Z. \\ \mathcal{W} = B^3 + BXY + XYZ \\ + \text{tr}(B)B^2 + \text{tr}(B)XY \end{array} \\
 & & & (5.58)
 \end{aligned}$$

Applying it to (5.57) we get

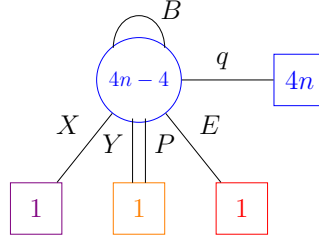

$$\begin{aligned} \mathcal{W} = & Bqq + YP + \text{Flip}[XE; qq; EP; Eq; Pq; XY] \\ & + B^3 + BXY + \text{tr}(B)B^2 + \text{tr}(B)XY \end{aligned} \quad (5.59)$$

where the superpotential term XYZ in (5.58) is now indicated as $\text{Flip}[XY]$, so the field Z in corresponds to the flipper of XY . At this stage, the antisymmetric field B is traceful. We also see that the fields Y and P are massive. After integrating them out, we obtain

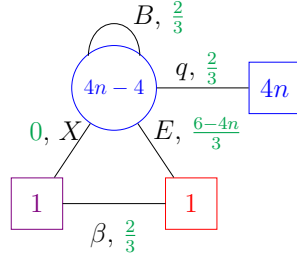

$$\begin{aligned} \mathcal{W} = & B^3 + \text{tr}(B)B^2 + Bqq + \text{Flip}[XE; BXE; Eq; BXq; qq] \\ & + \beta \text{Flipper}[BXE] XE + \beta \text{Flipper}[BXq] Xq + \text{Flipper}[BXE] \text{tr}(B)XE + \text{Flipper}[BXq] \text{tr}(B)Xq \end{aligned} \quad (5.60)$$

The theory that we obtained is precisely of the form of the one appearing in the l.h.s of (5.30), the special form of the $\mathcal{U}_2[2n-2, h=1]$ duality. We saw that the dual is given by

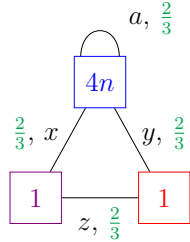

$$\equiv \text{[Quiver with blue square node } 4n+2 \text{ and self-loop } A, 2/3]$$

$$\mathcal{W} = A^3 + \text{tr}(A)A^2$$

$$\mathcal{W} = a^3 + axy + xyz \quad (5.61)$$

Where on the r.h.s. we simply recombined the fields into a $USp(4n+2)$ traceful antisymmetric.

The conclusion of this chain of dualities is that the l.h.s. of (5.55) is dual to the r.h.s. of (5.61), which is precisely the statement of the $\mathcal{U}_1[n]$ duality claimed in (5.6).

5.4 Understanding 4d SUSY enhancements using 3d S-confining dualities

Recently in [213] a $4d \mathcal{N} = 1$ theory that flows on a point of the $\mathcal{N} = 1$ conformal manifold of the $\mathcal{N} = 4$ SYM with gauge group $SU(2n+1)$ was constructed. In this section we propose an

understanding of this result from the perspective of the $3d$ reduction of these theories, which uses one of the S-confining dualities we previously discussed. The $3d$ perspective naturally suggests how to generalize the result of [213] and as an appetizer we propose a $4d$ $\mathcal{N} = 1$ theory that flows on a point of the same $\mathcal{N} = 1$ conformal manifold of an $\mathcal{N} = 2$ necklace quiver theory.

5.4.1 $4d$ $\mathcal{N} = 1$ theory flowing to $\mathcal{N} = 4$ SYM

The theory considered in [213] is obtained via an $\mathcal{N} = 1$ gauging of the global symmetry of an $\mathcal{N} = 2$ SCFT (the same theory and similar ones were previously studied in [256]). The $\mathcal{N} = 2$ SCFT in question is the non-Lagrangian $D_2(SU(2n+1))$ theory [158, 162, 214], which can be engineered either as Type IIB on a 3-fold Calabi–Yau hypersurface singularity or as a class \mathcal{S} theory of type A_{2n} on a sphere with one irregular and one regular puncture. The latter realization makes it manifest that the theory has an $SU(2n+1)$ flavor symmetry. The construction of [213] consists of taking three copies of this $D_2(SU(2n+1))$ theory and performing an $\mathcal{N} = 1$ gauging of their diagonal $SU(2n+1)$ symmetry. The theory can be summarized by the following quiver:

$$\begin{array}{ccc}
 & D_2(SU(2n+1)) & \\
 & | & \\
 & \textcircled{2n+1} & \mathcal{W} = 0 \\
 & / \quad \backslash & \\
 D_2(SU(2n+1)) & & D_2(SU(2n+1))
 \end{array} \tag{5.62}$$

The claim of [213] is that the resulting model flows to a point of the $\mathcal{N} = 1$ conformal manifold of the $\mathcal{N} = 4$ SYM with gauge group $SU(2n+1)$.

The $\mathcal{N} = 1$ theory has naively three $U(1)$ symmetries. In fact, on top of the $SU(2n+1)$ flavor symmetry, each $D_2(SU(2n+1))$ theory has an $\mathcal{N} = 2$ R-symmetry $SU(2)_R \times U(1)_r$, which when thought of as an $\mathcal{N} = 1$ theory decomposes to $U(1)_{R_0} \times U(1)_F$ where $U(1)_{R_0}$ is the $\mathcal{N} = 1$ R-symmetry while $U(1)_F$ is a flavor symmetry from the $\mathcal{N} = 1$ perspective. After the $\mathcal{N} = 1$ gauging of three copies of $D_2(SU(2n+1))$, the $U(1)_{R_0}$ symmetries of each of them get identified and give the reference R-symmetry of the resulting theory, while the three $U(1)_F$ symmetries remain as flavor symmetries. Nevertheless, one combination of them is gauge anomalous, so that the full continuous non-anomalous symmetry is only $U(1)^2$. This is then identified with the Cartan of the $SU(3)$ flavor symmetry of the $\mathcal{N} = 4$ SYM when considered as an $\mathcal{N} = 1$ theory.

The conclusion of [213] is that the $\mathcal{N} = 1$ theory obtained by gauging three copies of $D_2(SU(2n+1))$ flows to a point of the conformal manifold of the $\mathcal{N} = 4$ SYM with gauge group $SU(2n+1)$ where only $\mathcal{N} = 1$ supersymmetry and the $U(1)^2$ flavor symmetry is manifest. We next want to review the structure of the conformal manifold of the SYM theory and clarify which one is the specific point reached by the $\mathcal{N} = 1$ theory of [213].

The $\mathcal{N} = 4$ SYM when considered as an $\mathcal{N} = 1$ theory consists of an $SU(2n+1)$ gauge group and three adjoint chiral fields Φ_i with $i = 1, 2, 3$. These have $U(1)_R$ R-charge $\frac{2}{3}$ and are

rotated by the $SU(3)$ flavor symmetry. The $\mathcal{N} = 1$ superpotential compatible preserving these symmetries is

$$\mathcal{W}_{\text{SYM}}^{\mathcal{N}=4} = \lambda \text{Tr} (\Phi_1 [\Phi_2, \Phi_3]) , \quad (5.63)$$

where λ is related to the gauge coupling τ and the trace is taken over the $SU(2n+1)$ color indices.

The $\mathcal{N} = 1$ conformal manifold is three dimensional [263]. One direction is parametrized by the gauge coupling τ and preserves the full $\mathcal{N} = 4$ supersymmetry as well as the $SU(3)$ flavor symmetry. The other two directions, along which only $\mathcal{N} = 1$ is preserved, are parametrized by some cubic invariants constructed from the adjoint chirals Φ_i that correspond to exactly marginal deformations. These can be found by looking at space of all the marginal deformations, which are in the $\mathbf{10} \oplus \mathbf{1}$ of $SU(3)$ where $\mathbf{1}$ is the gauge coupling, and quotienting by the complexified flavor symmetry [272–275]. The generic point of the $\mathcal{N} = 1$ conformal manifold is reached by turning on the superpotential

$$\mathcal{W}_{\text{SYM}}^{\mathcal{N}=1} = \lambda \text{Tr} (\Phi_1 (e^{i\beta} \Phi_2 \Phi_3 - e^{-i\beta} \Phi_3 \Phi_2)) + \eta \text{Tr} (\Phi_1^3 + \Phi_2^3 + \Phi_3^3) . \quad (5.64)$$

When $\beta = \eta = 0$ we go back to the $\mathcal{N} = 4$ line. When $\eta = 0$ but $\beta \neq 0$ we have the so-called β -deformation, which breaks supersymmetry to $\mathcal{N} = 1$ and also the $SU(3)$ flavor symmetry to its Cartan $U(1)^2$. When $\eta \neq 0$ the continuous flavor symmetry is broken completely.

The direction of the conformal manifold to which the $\mathcal{N} = 1$ theory of [213] flows is the one parametrized by the β -deformation. In particular, since the $\mathcal{N} = 1$ theory (5.62) with $\mathcal{W} = 0$ has an S_3 symmetry that permutes the three $D_2(SU(2n+1))$ building blocks, this implies that it flows to a point of the conformal manifold of $\mathcal{N} = 4$ SYM with $\beta = \pi$. Indeed, $\beta = \pi$ is the only value of β for which (5.64) is S_3 -symmetric in the Φ_i (at $\beta = 0$ there is the Weyl group of $SU(3)$, which is an S_3 acting as the *signed* permutations of the three Φ_i 's, so it does not seem possible that (5.62) with $\mathcal{W} = 0$ flows to a point on the line $\beta = 0$, which is the $\mathcal{N} = 4$ supersymmetric locus). Notice that the S_3 permutation symmetry imposes that the moment maps μ_i from the $SU(2n+1)$ symmetry of the three $D_2(SU(2n+1))$ theories share the same R-charge, which can be determined by the vanishing of the ABJ anomaly. Hence a-maximization [232] is not really required to conclude that under the superconformal R-symmetry the operators μ_i have the canonical R-charge $\frac{2}{3}$, which is crucial for the claim that this theory is related to $\mathcal{N} = 4$ SYM.

We would like to reduce both the $\mathcal{N} = 1$ theory of [213] and the dual β, η -deformed $\mathcal{N} = 4$ SYM on a circle to three dimensions. Before doing the dimensional reduction, we thus further deform (5.62) with also the two marginal η and β deformations, so to go on the most generic point of the conformal manifold. On the side of the $\mathcal{N} = 1$ gauging of three copies of $D_2(SU(2n+1))$ this means that we are turning on the superpotential deformation

$$\delta\mathcal{W} = \hat{\lambda} \text{Tr} \left(\mu_1 \left(e^{i\hat{\beta}} \mu_2 \mu_3 - e^{-i\hat{\beta}} \mu_3 \mu_2 \right) \right) + \hat{\eta} \text{Tr} (\mu_1^3 + \mu_2^3 + \mu_3^3) , \quad (5.65)$$

where again μ_i is the moment map operator for the $SU(2n+1)$ flavor symmetry of the i -th $D_2(SU(2n+1))$ theory and it is mapped to Φ_i on the SYM side. The variables $\{\hat{\eta}, \hat{\beta}, \hat{\lambda}\}$ should map to the variables $\{\eta, \beta, \lambda\}$. We do not know the precise mapping, but for symmetry reasons

it must be that $\hat{\eta} = 0$ if and only if $\eta = 0$, and that when $\eta = 0$, $\hat{\beta} = 0, \pi$ if and only if $\beta = 0, \pi$, which is all that we need to know for our purposes.

Reduction to 3d

Our next goal is to show that the resulting $3d \mathcal{N} = 2$ theory is dual to the $3d \mathcal{N} = 8$ SYM with gauge group $SU(2n + 1)$ on a generic point of the three-dimensional $4d \mathcal{N} = 1$ conformal manifold, where supersymmetry is broken to $3d \mathcal{N} = 2$ and the flavor symmetry is completely broken.

In order to show this, we use the remarkable fact that the circle reduction of the $4d \mathcal{N} = 2$ $D_2(SU(2n + 1))$ SCFT is Lagrangian and it is given by the $3d \mathcal{N} = 4$ SQCD with $U(n)$ gauge group and $2n + 1$ fundamental hypermultiplets [158, 260–262]. Hence, the circle reduction of the $4d \mathcal{N} = 1$ theory of [213] obtained by gauging three copies of $D_2(SU(2n + 1))$ is a $3d \mathcal{N} = 2$ Lagrangian theory that can be summarized with the following quiver:

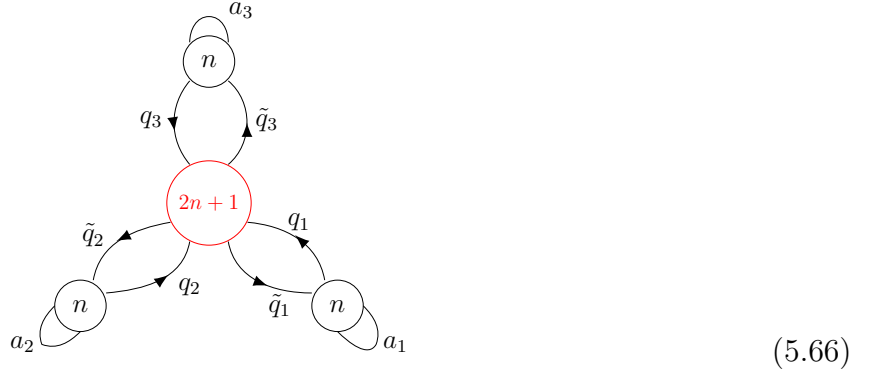

We claim that, after starting from the $4d$ theory with the deformation (5.65), the superpotential of this $3d \mathcal{N} = 2$ theory is

$$\mathcal{W}_{3d} = \hat{\lambda} \left(\mu_1 \left(e^{i\hat{\beta}} \mu_2 \mu_3 - e^{-i\hat{\beta}} \mu_3 \mu_2 \right) \right) + \hat{\eta} \left(\sum_{i=1}^3 \mu_i^3 \right) + \sum_{i=1}^3 (a_i q_i \tilde{q}_i + \mathfrak{M}_i^+ + \mathfrak{M}_i^-), \quad (5.67)$$

where $\mu_i = q_i \tilde{q}_i$ with the contraction of the $U(n)$ indices being understood and \mathfrak{M}_i^\pm are the fundamental monopoles of the i -th $U(n)$ gauge group. The terms $a_i q_i \tilde{q}_i$ come from the superpotential of the $3d \mathcal{N} = 4$ theory when considered as a $3d \mathcal{N} = 2$ theory. Instead, we claim that the monopole superpotentials $\mathfrak{M}_i^+ + \mathfrak{M}_i^-$ are dynamically generated in the compactification by the same arguments of [103, 104]. The above superpotential sets the R-charges of the $3d$ fields to the values

$$R[a_i] = \frac{4}{3}, \quad R[q_i] = R[\tilde{q}_i] = \frac{1}{3}, \quad (5.68)$$

which implies that the monopoles \mathfrak{M}_i^\pm have R-charge 2 and can thus be dynamically generated in the superpotential.

This monopole superpotential is crucial, since now we can apply the S-confining duality $\mathcal{U}_1^{(3d)}[n]$ in (5.13) to each of the three $U(n)$ nodes. The net effect is to replace each of these gauge nodes with an adjoint chiral Φ_i for the middle $SU(2n + 1)$ node, which are mapped to $\mu_i = q_i \tilde{q}_i$ before applying the duality. In the dualization we also produce the Φ_i^3 terms

in the superpotential, but these were already present due to the original η -deformation. To summarize, we obtain the following quiver¹⁵

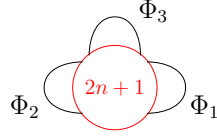

$$\mathcal{W}_{3d} = \hat{\lambda} \text{Tr} \left(\Phi_1 \left(e^{i\hat{\beta}} \Phi_2 \Phi_3 - e^{-i\hat{\beta}} \Phi_3 \Phi_2 \right) \right) + \tilde{\eta} \text{Tr} \left(\sum_{i=1}^3 \Phi_i^3 \right) \quad (5.69)$$

It corresponds precisely to the 3d $\mathcal{N} = 8$ SYM with gauge group $SU(2n+1)$ on a generic point of the 4d conformal manifold, in agreement with the claim of [213].

5.4.2 4d $\mathcal{N} = 1$ theory flowing to an $\mathcal{N} = 2$ necklace quiver

Using the 3d perspective we can quite naturally understand how to possibly generalize the findings of [213] to other $\mathcal{N} = 1$ gaugings of $D_2(SU(2n+1))$ so to get an $\mathcal{N} = 2$ Lagrangian theory. The idea is to replace adjoint chirals with copies of the $D_2(SU(2n+1))$ theory, and also bifundamental hypermultiplets, if we consider gauging only a subgroup of the flavor symmetry, which would come from the related decomposition of the moment map μ . From our previous analysis it seems that a crucial necessary requirement in order for the construction to work is that the $\mathcal{N} = 2$ theory admits an $\mathcal{N} = 1$ preserving exactly marginal deformation which completely breaks the continuous flavor symmetry and that can be eventually related to the Φ^3 superpotential in the 3d S-confining duality.

As an example, let us consider the 4d $\mathcal{N} = 2$ necklace quiver theory with three $SU(2n+1)$ gauge nodes

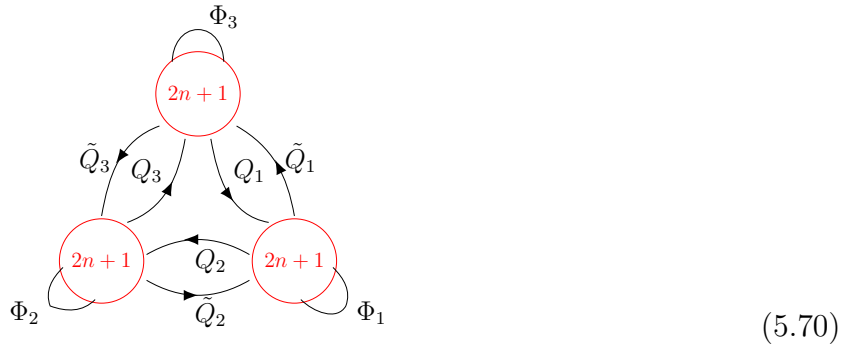

$$(5.70)$$

which we drew in $\mathcal{N} = 1$ notation. The superpotential is

$$\mathcal{W}_{\text{necklace}}^{\mathcal{N}=2} = \sum_{i=1}^3 \lambda_i \text{Tr} (\Phi_i (Q_i \tilde{Q}_i - Q_{i+1} \tilde{Q}_{i+1})), \quad (5.71)$$

where $Q_4 = Q_1$ and $\tilde{Q}_4 = \tilde{Q}_1$.

The continuous global symmetries of the theory depend on the position on the conformal manifold. There is a 3-complex dimensional conformal manifold with $\mathcal{N} = 2$ supersymmetry, parameterized by the 3 gauge couplings. On this $\mathcal{N} = 2$ conformal manifold the superpotential couplings λ_i are set by supersymmetry in terms of the gauge couplings. The global symmetry

¹⁵Here $\tilde{\eta}$ is different from $\hat{\eta}$ in (5.67) due to the application of the duality.

is $\prod_{i=1}^3 U(1)_{i,baryonic} \times SU(2)_R \times U(1)_r$, where the i^{th} baryonic $U(1)$ acts on the fields $\{Q_i, \tilde{Q}_i\}$ with charges $\{+1, -1\}$ and with zero charge on the other fields.

In $\mathcal{N} = 1$ language the visible global symmetry is

$$\prod_{i=1}^3 U(1)_{i,baryonic} \times U(1)_F \times U(1)_{R_0}, \quad (5.72)$$

where $U(1)_F$ acts with charges $+2, -1, -1$ on Φ_i, Q_i, \tilde{Q}_i , respectively, while $U(1)_{R_0}$ is the canonical $\mathcal{N} = 1$ R-symmetry under which all the fields Φ_i, Q_i, \tilde{Q}_i have R-charge $\frac{2}{3}$.

$\mathcal{N} = 1$ conformal manifold of the necklace quiver

We are interested in the full $\mathcal{N} = 1$ conformal manifold of the $SU(N)^3$ necklace (in Appendix E we discuss the general \mathbb{Z}_k orbifold of $\mathcal{N} = 4$ SYM, which as far as we are aware was never determined in the literature). We use the method of [272], of quotienting the space of marginal deformations (that is the chiral ring operators with $U(1)_{R_0}$ R-charge $R_0 = 2$) by the broken global symmetries.

There are 6 operators with $R_0 = 2$ in the chiral ring

$$\text{Tr}(\Phi Q \tilde{Q}), \quad \text{Tr}(\Phi_1^3), \quad \text{Tr}(\Phi_2^3), \quad \text{Tr}(\Phi_3^3), \quad \text{Tr}(Q_1 Q_2 Q_3), \quad \text{Tr}(\tilde{Q}_3 \tilde{Q}_2 \tilde{Q}_1), \quad (5.73)$$

where $\text{Tr}(\Phi Q \tilde{Q})$ represents the only operator in the chiral ring of the form $\Phi Q \tilde{Q}$, since all of the operators of this form are equal in the chiral ring due to the F-terms relations, more precisely we can write this operator as

$$\text{Tr}(\Phi Q \tilde{Q}) = \sum_{i=1}^3 \text{Tr}(\Phi_i Q_i \tilde{Q}_i + \Phi_i Q_{i+1} \tilde{Q}_{i+1}), \quad (5.74)$$

This is the operator which drives the so-called β -deformation, which exists in all SCFTs on D3-branes at toric Calabi–Yau singularities [273].

Turning on the operators in (5.73), the global symmetry (5.72) is broken to $U(1)_{baryonic}^2 \times U(1)_{R_0}$. The rank of the global symmetry decreases by 2 units. This implies that there are $6 - 2 = 4$ directions in the full $\mathcal{N} = 1$ conformal manifold, which is thus 7-dimensional.

One submanifold which is useful for us has a special point where the S_3 exchange symmetry of the 3 nodes is preserved. Such submanifold has superpotential

$$\begin{aligned} \mathcal{W}_{\text{necklace}}^{\mathcal{N}=1} &= \lambda \sum_{i=1}^3 \text{Tr}(\Phi_i (e^{i\beta} Q_i \tilde{Q}_i - e^{-i\beta} Q_{i+1} \tilde{Q}_{i+1})) \\ &+ \eta_1 \sum_{i=1}^3 \text{Tr}(\Phi_i^3) + \eta_2 (\text{Tr}(Q_1 Q_2 Q_3) + \text{Tr}(\tilde{Q}_3 \tilde{Q}_2 \tilde{Q}_1)). \end{aligned} \quad (5.75)$$

This is a 3-dimensional manifold parameterized by the gauge coupling, λ, β (in terms of which the couplings η_1 and η_2 are set). In particular, we observe that the point $\beta = \pi$ is invariant under the S_3 exchange symmetry of the three gauge nodes. The superpotential (5.75) will also be useful when compactifying to $3d$ because the last two terms force the R-charges of the elementary fields to be $\frac{2}{3}$ also in $3d$, which as we have seen in the previous subsection is crucial for our analysis.

Construction via $\mathcal{N} = 1$ gauging of the $D_2(SU(6n+3))$ theory

We claim that we can construct an $\mathcal{N} = 1$ theory that flows to point on the direction of the conformal manifold of the $\mathcal{N} = 2$ necklace quiver theory corresponding to the β -deformation by taking one copy of the $D_2(SU(6n+3))$ theory and gauging its $SU(2n+1)^3$ subgroup. The symbolic quiver representing this theory is as follows:

$$(5.76)$$

The moment map μ in the adjoint representation of the $SU(6n+3)$ flavor symmetry decomposes under the $SU(2n+1)^3 \times U(1)^2$ subgroup as

$$\begin{aligned} \mathbf{adj}_{[\mu]} \rightarrow & 2 \times (\mathbf{1}, \mathbf{1}, \mathbf{1})_{[s_1, s_2]}^{(0,0)} \oplus (\mathbf{adj}, \mathbf{1}, \mathbf{1})_{[\Phi_1]}^{(0,0)} \oplus (\mathbf{1}, \mathbf{adj}, \mathbf{1})_{[\Phi_2]}^{(0,0)} \oplus (\mathbf{1}, \mathbf{1}, \mathbf{adj})_{[\Phi_3]}^{(0,0)} \\ & \oplus (\mathbf{2n+1}, \mathbf{1}, \overline{\mathbf{2n+1}})_{[Q_1]}^{(0,-1)} \oplus (\overline{\mathbf{2n+1}}, \mathbf{1}, \mathbf{2n+1})_{[\tilde{Q}_1]}^{(0,1)} \oplus (\overline{\mathbf{2n+1}}, \mathbf{2n+1}, \mathbf{1})_{[Q_2]}^{(-1,0)} \\ & \oplus (\mathbf{2n+1}, \overline{\mathbf{2n+1}}, \mathbf{1})_{[\tilde{Q}_2]}^{(1,0)} \oplus (\mathbf{1}, \overline{\mathbf{2n+1}}, \mathbf{2n+1})_{[Q_3]}^{(1,-1)} \oplus (\mathbf{1}, \mathbf{2n+1}, \overline{\mathbf{2n+1}})_{[\tilde{Q}_3]}^{(-1,1)}, \end{aligned} \quad (5.77)$$

where the superscripts are the $U(1)^2$ charges while the subscripts indicate the field in the $\mathcal{N} = 2$ necklace quiver to which each state corresponds. Hence, the intuition from the $3d$ perspective is that after applying the S-confining duality μ will decompose into the three adjoint chirals and the three pairs of bifundamental chirals that form the necklace quiver. Notice that μ also supplements two extra singlets that we will need to flip in order to get the $\mathcal{N} = 2$ theory and we will see momentarily that this is further justified by the fact that if we don't do so they would give a decoupled free sector.

We claim that the theory (5.76) with superpotential $\mathcal{W} = \text{Flip}[s_1; s_2]$ flows to a point on the conformal manifold of the $\mathcal{N} = 2$ necklace quiver that sits on the β -deformation line. If we want instead to go to a more generic point of the conformal manifold corresponding to (5.75), then the superpotential is (the name of the fields are the ones appearing in the decomposition of the moment map (5.77))

$$\begin{aligned} \mathcal{W} = & \hat{\lambda} \sum_{i=1}^3 \text{Tr}(\Phi_i(e^{i\hat{\beta}} Q_i \tilde{Q}_i - e^{-i\hat{\beta}} Q_{i+1} \tilde{Q}_{i+1})) + \hat{\eta}_1 \sum_{i=1}^3 \text{Tr}(\Phi_i^3) \\ & + \hat{\eta}_2 (\text{Tr}(Q_1 Q_2 Q_3) + \text{Tr}(\tilde{Q}_3 \tilde{Q}_2 \tilde{Q}_1)) + \text{Flip}[s_1; s_2]. \end{aligned} \quad (5.78)$$

Let us analyze this $\mathcal{N} = 1$ model more in details. First of all, it naively has three abelian symmetries, where two of them come from the decomposition $SU(6n+3) \rightarrow SU(2n+1)^3 \times U(1)^2$, while the third $U(1)_F$ is the commutant of the $\mathcal{N} = 1$ $U(1)_{R_0}$ R-symmetry inside the $\mathcal{N} = 2$ $SU(2)_R \times U(1)_r$ R-symmetry

$$R_0 = \frac{1}{3}r + \frac{4}{3}I_3, \quad F = -r + 2I_3, \quad (5.79)$$

where R_0 , F and r are the generators of $U(1)_{R_0}$, $U(1)_F$ and $U(1)_r$ respectively, while I_3 is the generator of the Cartan of $SU(2)_R$. We use here the usual parametrization where for a hypermultiplet scalar $r = 0$ and $I_3 = \frac{1}{2}$ while for a gaugino $r = 1$ and $I_3 = 0$. Nevertheless, the $U(1)_F$ symmetry is anomalous and so the actual symmetry of the model is only $U(1)^2$.

We also observe that the $\mathcal{N} = 1$ theory has an S_3 symmetry that comes from the Weyl group of the original $SU(6n + 3)$ symmetry which is not part of the Weyl of the gauged $SU(3n + 1)^3$ symmetry and which acts by permuting these three factors. These considerations about the continuous and discrete global symmetries of the model, remembering our observation below (5.75), suggest that the particular point of the conformal manifold of the $4d$ $\mathcal{N} = 2$ necklace theory to which the $\mathcal{N} = 1$ theory in (5.76) with only the flipping superpotential flows is the one with $\beta = \pi$. At this point indeed the theory has $\mathcal{N} = 1$ supersymmetry, $U(1)^2$ continuous symmetry and S_3 discrete symmetry.

In order to that the $U(1)_F$ symmetry is anomalous, we first define the trial $U(1)_{R_{\text{trial}}}$ R-symmetry obtained by mixing $U(1)_{R_0}$ with $U(1)_F$

$$R_{\text{trial}} = R_0 + \epsilon F. \quad (5.80)$$

Notice that we didn't consider a mixing with the other $U(1)^2$ symmetries. This is because they come from the non-abelian symmetry $SU(6n + 3)$ of the $D_2(SU(6 + 3))$ symmetry whose cubic anomaly vanishes, and so all anomalies that do not involve these $U(1)^2$ symmetries quadratically vanish implying that any mixing coefficient with them would be set to zero by the a -maximization. Then we want to compute its ABJ anomaly

$$\text{Tr } R_{\text{trial}} SU(2n + 1)^2 = 2n + 1 + \text{Tr } R_{\text{trial}} SU(2n + 1)^2 \Big|_{D_2(SU(6n+3))}, \quad (5.81)$$

where the first part is the contribution of the gauginos while the second part is the contribution of the $D_2(SU(6n + 3))$ theory. The latter can be obtained as follows:

$$\begin{aligned} \text{Tr } R_{\text{trial}} SU(2n + 1)^2 \Big|_{D_2(SU(6n+3))} &= \left(\frac{1}{3} - \epsilon \right) \text{Tr } r SU(6n + 3)^2 \Big|_{D_2(SU(6n+3))} \\ &\quad + \left(\frac{4}{3} + 2\epsilon \right) \text{Tr } I_3 SU(6n + 3)^2 \Big|_{D_2(SU(6n+3))} \\ &= - \left(\frac{1}{3} - \epsilon \right) \frac{k_{4d}^{SU(6n+3)}}{2} = - \left(\frac{1}{3} - \epsilon \right) \frac{6n + 3}{2}, \end{aligned} \quad (5.82)$$

where we used that the embedding index fo $SU(2n + 1)$ inside $SU(6n + 3)$ is trivial and that for a $4d$ $\mathcal{N} = 2$ SCFT

$$\text{Tr } r F^2 = -\frac{k_{4d}^F}{2}, \quad \text{Tr } I_3 F^2 = 0, \quad (5.83)$$

with k_{4d}^F is the flavor symmetry central charge, which for the $SU(N)$ symmetry of a $D_p(SU(N))$ theory is [276]

$$k_{4d}^{SU(N)} = 2N - \frac{2N}{p}. \quad (5.84)$$

Overall, we then find the ABJ anomaly

$$\text{Tr } R_{\text{trial}} SU(2n + 1)^2 = 2n + 1 - \left(\frac{1}{3} - \epsilon \right) \frac{6n + 3}{2} \quad (5.85)$$

and requiring that it vanishes fixes

$$\epsilon = -\frac{1}{3}. \quad (5.86)$$

As we mentioned before the other $U(1)^2$ symmetries cannot mix with the R-symmetry, so the previous computation determines what will be the superconformal R-symmetry of the theory

$$R_{\text{s.c.}} = R_0 - \frac{1}{3}F = \frac{2}{3}(r + I_3). \quad (5.87)$$

Notice in particular that this gives the R-charge $\frac{2}{3}$ to the moment map μ , which is necessary to connect with the $\mathcal{N} = 2$ necklace theory where as we commented above the components of μ are associated to the fields Φ_i , Q_i and \tilde{Q}_i . On the other hand, we see that the two singlets in the decomposition (5.77) are gauge invariants with the free R-charge and so they should be flipped.

We now want to compute the a and c central charges and check that they match those of the $\mathcal{N} = 2$ necklace theory. For this, we first compute

$$\text{Tr } R_{\text{s.c.}} = 3 \times 4n(n+1) + 2 \left(\frac{4}{3} - 1 \right) + \frac{2}{3} \text{Tr } r \Big|_{D_2(SU(6n+3))} = -2 \quad (5.88)$$

where the first term is the contribution of the gauginos, the second one is from the flipper fields and the last term is the contribution of $D_2(SU(6n+3))$ which was computed using [162, 207, 277]

$$\text{Tr } r \Big|_{D_2(SU(6n+3))} = 48 (a_{D_2(SU(6n+3))} - c_{D_2(SU(6n+3))}) = -2 (9n^2 + 9n + 2). \quad (5.89)$$

We then compute

$$\begin{aligned} \text{Tr } R_{\text{s.c.}}^3 &= 3 \times 4n(n+1) + 2 \left(\frac{4}{3} - 1 \right)^3 + \frac{8}{9} \text{Tr } r I_3^2 \Big|_{D_2(SU(6n+3))} + \frac{8}{27} \text{Tr } r^3 \Big|_{D_2(SU(6n+3))} \\ &= \frac{2}{9} (48n^2 + 48n - 1), \end{aligned} \quad (5.90)$$

where we used that

$$\begin{aligned} \text{Tr } r I_3^2 \Big|_{D_2(SU(6n+3))} &= 4a_{D_2(SU(6n+3))} - 2c_{D_2(SU(6n+3))} = \frac{1}{2} (9n^2 + 9n + 2), \\ \text{Tr } r^3 \Big|_{D_2(SU(6n+3))} &= 48 (a_{D_2(SU(6n+3))} - c_{D_2(SU(6n+3))}) = -2 (9n^2 + 9n + 2). \end{aligned} \quad (5.91)$$

We finally find the conformal a and c central charges (2.77)-(2.78)

$$\begin{aligned} a &= \frac{3}{32} (3 \text{Tr } R_{\text{s.c.}}^3 - \text{Tr } R_{\text{s.c.}}) = 3n^2 + 3n + \frac{1}{8}, \\ c &= \frac{1}{32} (9 \text{Tr } R_{\text{s.c.}}^3 - 5 \text{Tr } R_{\text{s.c.}}) = 3n^2 + 3n + \frac{1}{4}, \end{aligned} \quad (5.92)$$

which precisely coincide with those of the $\mathcal{N} = 2$ necklace quiver theory

$$\begin{aligned} a &= \frac{5n_v + n_h}{24} = 3n^2 + 3n + \frac{1}{8}, \\ c &= \frac{2n_v + n_h}{12} = 3n^2 + 3n + \frac{1}{4}, \end{aligned} \quad (5.93)$$

where $n_v = 12n(n+1)$ is the number of $\mathcal{N} = 2$ vectors and $n_h = 3(2n+1)^2$ is the number of hypers.

Reduction to $3d$

Now we want to reduce the theory (5.76) with superpotential (5.78) to $3d$. Using once again the Lagrangian theory corresponding to the circle reduction of $D_2(SU(6n+3))$ we get the following quiver:

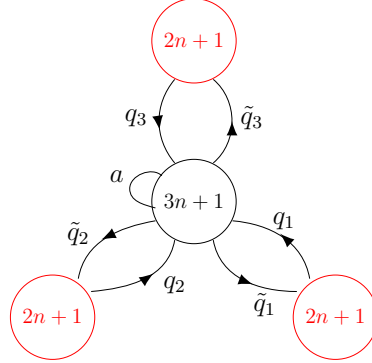

$$\begin{aligned} \mathcal{W} = & \sum_{i=1}^3 \text{Tr}((q_i \tilde{q}_i)^3) + (\text{Tr}([q_3 \tilde{q}_1][q_1 \tilde{q}_2][q_2 \tilde{q}_3]) + \text{Tr}([\tilde{q}_3 q_1][\tilde{q}_1 q_2][\tilde{q}_2 q_3])) \\ & + \text{Flip}[\text{Tr}(q_1 \tilde{q}_1); \text{Tr}(q_2 \tilde{q}_2)] + a \sum_{i=1}^3 q_i \tilde{q}_i + \mathfrak{M}^+ + \mathfrak{M}^- \end{aligned} \quad (5.94)$$

Now we can apply the S-confining duality $\mathcal{U}_1^{(3d)}[n]$ of Section 5.2.1 to the central $U(3n+1)$ node to obtain

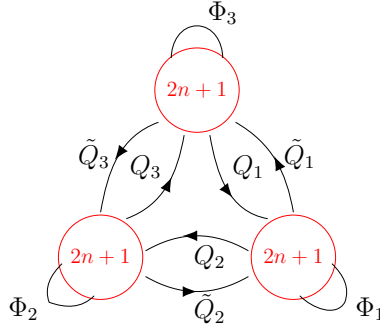

$$\begin{aligned} \mathcal{W} = & \sum_{i=1}^3 \text{Tr}(\Phi_i (e^{i\hat{\beta}} Q_i \tilde{Q}_i - e^{-i\hat{\beta}} Q_{i+1} \tilde{Q}_{i+1})) \\ & + \sum_{i=1}^3 \text{Tr}(\Phi_i^3) + (\text{Tr}(Q_1 Q_2 Q_3) + \text{Tr}(\tilde{Q}_3 \tilde{Q}_2 \tilde{Q}_1)) \end{aligned} \quad (5.95)$$

It corresponds precisely to the $3d$ reduction of the $4d$ necklace quiver (5.70) on a generic point of its conformal manifold which sustains our proposed $4d$ duality.

Superconformal index

We can perform a further check of our claim that the $\mathcal{N} = 1$ gauging of the $SU(2n+1)^3$ subgroup of one copy of $D_2(SU(6n+3))$ flows to a direction of the conformal manifold of the $\mathcal{N} = 2$ necklace quiver theory that preserves a $U(1)^2$ flavor symmetry. This was also done in [213] for their $\mathcal{N} = 4$ example and it consists of matching a limit of the superconformal index. We reviewed more in details our conventions for the $4d$ superconformal index in Section 2.10, while here we only use some specific facts that are useful for our analysis.

The superconformal index of a $4d$ $\mathcal{N} = 1$ theory is defined as

$$\mathcal{I}_{\mathcal{N}=1} = \text{Tr}_{\delta=0}(-1)^F \left(\frac{p}{q}\right)^{j_1} (pq)^{j_2 + \frac{R}{2}} \prod_i f_i^{T_i}, \quad (5.96)$$

where $\delta = 2j_2 + \frac{3}{2}R$, R is the generator of the IR superconformal R-symmetry and f_i , T_i are fugacities and generators for additional global symmetries of the theory. As we have seen previously, for our $\mathcal{N} = 1$ model the superconformal R-symmetry is given by $R = R_0 + \epsilon F$ with $\epsilon = -\frac{1}{3}$ and the global symmetry is $U(1)^2$, so we can write

$$\mathcal{I}_{\mathcal{N}=1} = \text{Tr}_{\delta=0}(-1)^F \left(\frac{p}{q}\right)^{j_1} (pq)^{j_2 + \frac{R_0}{2} + \frac{\epsilon F}{2}} \prod_{i=1}^2 f_i^{T_i}. \quad (5.97)$$

Instead, the superconformal index of a $4d$ $\mathcal{N} = 2$ theory is defined as

$$\mathcal{I}_{\mathcal{N}=2} = \text{Tr}_{\delta=0}(-1)^F \left(\frac{p}{q}\right)^{j_1} (pq)^{j_2 + \frac{r}{2}} t^{I_3 - \frac{r}{2}} \prod_i f_i^{T_i}, \quad (5.98)$$

where now $\delta = 2j_2 + 2I_3 + \frac{r}{2}$ and we have one additional fugacity t due to the fact that the R-symmetry is larger. Remembering (5.79), we can rewrite this as

$$\mathcal{I}_{\mathcal{N}=2} = \text{Tr}_{\delta=0}(-1)^F \left(\frac{p}{q}\right)^{j_1} (pq)^{j_2 + \frac{R_0}{2} - \frac{F}{3} + \frac{F}{2}} \prod_i f_i^{T_i}. \quad (5.99)$$

As we have seen above, when we perform the $\mathcal{N} = 1$ gauging of the $\mathcal{N} = 2$ $D_2(SU(6n+3))$ theory one combination of $U(1)_{R_0}$ and $U(1)_F$ is broken by the ABJ anomaly. At the level of the index this means that we should lose one fugacity and indeed we can go from (5.99) to (5.97) by setting $t = (pq)^{\frac{2}{3} + \epsilon} = (pq)^{\frac{1}{3}}$.

The above considerations lead us to write the index of the $\mathcal{N} = 1$ gauging of the $SU(2n+1)^3$ subgroup of one copy of $D_2(SU(6n+3))$ as

$$\begin{aligned} \mathcal{I}_{\mathcal{N}=1}(f_1, f_2, p, q) &= \left(\mathcal{I}_{\text{chir}}^{\mathcal{N}=1} \left((pq)^{\frac{2}{3}}; p, q \right) \right)^2 \frac{1}{(2n+1)!^3} \oint \left[\prod_{a=1}^3 \left(\prod_{i=1}^{2n+1} \frac{dz_i^{(a)}}{2\pi i z_i^{(a)}} \right) \mathcal{I}_{\text{vec}}^{\mathcal{N}=1}(\vec{z}^{(a)}; p, q) \right] \\ &\times \mathcal{I}_{D_2(SU(6n+3))}(\vec{z}^{(1)}, \vec{z}^{(2)}, \vec{z}^{(3)}, f_1, f_2; p, q, t = (pq)^{\frac{1}{3}}). \end{aligned} \quad (5.100)$$

The first factor is the contribution of the flipper fields, which is written in terms of the index of a chiral multiplet with R-charge Δ

$$\mathcal{I}_{\text{chir}}^{\mathcal{N}=1} \left((pq)^{\frac{\Delta}{2}} x; p, q \right) = \text{PE} \left[\frac{(pq)^{\frac{\Delta}{2}} x - (pq)^{\frac{2-\Delta}{2}} x^{-1}}{(1-p)(1-q)} \right]. \quad (5.101)$$

The integral is over the Cartan of the gauge group $SU(2n+1)^3$, where the fugacities satisfy $\prod_i z_i^{(a)} = 1$. The contribution of an $\mathcal{N} = 1$ vector multiplet is

$$\mathcal{I}_{\text{vec}}^{\mathcal{N}=1}(\vec{z}; p, q) = \text{PE} \left[\frac{2pq - p - q}{(1-p)(1-q)} \chi_{\text{adj}}^{SU(2n+1)}(\vec{z}) \right], \quad (5.102)$$

where $\chi_{\text{adj}}^{SU(2k+1)}(\vec{u})$ is the character of the adjoint representation of $SU(2k+1)$, which in the following we are going to parametrize as

$$\chi_{\text{adj}}^{SU(2n+1)}(\vec{z}) = \sum_{i,j=1}^{2n+1} \frac{z_i}{z_j} - 1. \quad (5.103)$$

Finally, $\mathcal{I}_{D_2(SU(6n+3))}$ is the $\mathcal{N} = 2$ index of the $D_2(SU(6n+3))$ theory, where the fugacities for its $SU(6n+3)$ haven been decomposed in terms of those of the $SU(2n+1)^3 \times U(1)^2$ subgroup.

The $D_2(SU(6n+3))$ theory is non-Lagrangian and so its full index is in general not known. The only case for which it is known is for the $D_2(SU(3)) = (A_1, D_4)$ theory, for which one can compute it using the $\mathcal{N} = 1$ Lagrangians of [203–205, 211]. This corresponds to the case $n = 1$ which is degenerate since the $\mathcal{N} = 2$ necklace quiver doesn't have any gauge symmetry and only consists of 3 free hypers or 6 free chirals. In particular, since there is no gauge symmetry there is no reason to impose the constraint on the fugacities $t = (pq)^{\frac{1}{3}}$ due to the ABJ anomaly. Nevertheless, we curiously observe that the index of the $D_2(SU(3))$ theory computed in eq. (5.12) of [205] still reduces to the index of eight chirals of R-charge $\frac{2}{3}$ after the specialization $t = (pq)^{\frac{1}{3}}$, where the two extra chirals are removed once we add the flipper fields.

For the general n case, we can still match a particular limit of the full index. Indeed, there is a famous limit of the $\mathcal{N} = 2$ index known as the *Schur limit* [278] which is known for a generic $D_2(SU(2k+1))$ theory [276, 279]

$$\mathcal{I}_{D_2(SU(2k+1))}(\vec{u}; p, q, t = q) = \text{PE} \left[\frac{q}{1 - q^2} \chi_{\text{adj}}^{SU(2k+1)}(\vec{u}) \right], \quad (5.104)$$

with $\prod_i u_i = 1$. Hence, in our case we have

$$\mathcal{I}_{D_2(SU(6n+3))}(\vec{z}^{(1)}, \vec{z}^{(2)}, \vec{z}^{(3)}, f_1, f_2; p, q, t = q) = \text{PE} \left[\frac{q}{1 - q^2} \chi_{\text{adj}}^{SU(6n+3)}(\vec{z}^{(1)}, \vec{z}^{(2)}, \vec{z}^{(3)}, f_1, f_2) \right], \quad (5.105)$$

where we decompose the character of the adjoint representation of $SU(6n+3)$ according to the branching rule (5.77)

$$\begin{aligned} \chi_{\text{adj}}^{SU(6n+3)}(\vec{z}^{(1)}, \vec{z}^{(2)}, \vec{z}^{(3)}, f_1, f_2) &= 2 + \sum_{a=1}^3 \chi_{\text{adj}}^{SU(2n+1)}(\vec{z}^{(a)}) \\ &+ f_2^{-1} \chi_{\text{fund}}^{SU(2n+1)}(z^{(1)}) \chi_{\text{fund}}^{SU(2n+1)}(z^{(3)}) + f_2 \chi_{\text{fund}}^{SU(2n+1)}(z^{(1)}) \chi_{\text{fund}}^{SU(2n+1)}(z^{(3)}) \\ &+ f_1^{-1} \chi_{\text{fund}}^{SU(2n+1)}(z^{(1)}) \chi_{\text{fund}}^{SU(2n+1)}(z^{(2)}) + f_1 \chi_{\text{fund}}^{SU(2n+1)}(z^{(1)}) \chi_{\text{fund}}^{SU(2n+1)}(z^{(2)}) \\ &+ \frac{f_1}{f_2} \chi_{\text{fund}}^{SU(2n+1)}(z^{(2)}) \chi_{\text{fund}}^{SU(2n+1)}(z^{(3)}) + \frac{f_2}{f_1} \chi_{\text{fund}}^{SU(2n+1)}(z^{(2)}) \chi_{\text{fund}}^{SU(2n+1)}(z^{(3)}). \end{aligned} \quad (5.106)$$

This means that we can study the limit of the index of the $\mathcal{N} = 1$ theory in which $q = t = (pq)^{\frac{1}{3}}$, that is $p = q^2$. First of all, in this limit the contribution of the flipper fields becomes

$$\left(\mathcal{I}_{\text{chir}}^{\mathcal{N}=1} \left((pq)^{\frac{2}{3}}; p, q \right) \right)^2 \Big|_{p=q^2} = \text{PE} \left[-\frac{2q}{1 - q^2} \right] \quad (5.107)$$

and so it simplifies against that of the first two singlets in (5.106), as expected since their purpose was to remove this decoupled free sector from the theory. Instead, the remaining

contribution of the $D_2(SU(6n+3))$ theory in (5.105) becomes equivalent to the index of chiral multiplets in the representations appearing in (5.106) except the singlets and with R-charge $\frac{2}{3}$. This is because the index of a chiral of R-charge $\frac{2}{3}$ in the limit $p = q^2$ is (remember (5.101))

$$\mathcal{I}_{\text{chir}}^{\mathcal{N}=1} \left((pq)^{\frac{1}{3}}; p, q \right) \Big|_{p=q^2} = \text{PE} \left[\frac{q}{1-q^2} \right]. \quad (5.108)$$

Hence, we end up precisely with the index of the $\mathcal{N} = 2$ necklace quiver theory in the limit $p = q^2$

$$\begin{aligned} \mathcal{I}_{\mathcal{N}=1}(f_1, f_2, p = q^2, q) &= \frac{1}{(2n+1)!^3} \oint \left[\prod_{a=1}^3 \left(\prod_{i=1}^{2n+1} \frac{dz_i^{(a)}}{2\pi i z_i^{(a)}} \right) \mathcal{I}_{\text{vec}}^{\mathcal{N}=1}(\vec{z}^{(a)}; p = q^2, q) \right] \\ &\times \frac{1}{\left(\mathcal{I}_{\text{chir}}^{\mathcal{N}=1} \left((pq)^{\frac{1}{3}}; p = q^2, q \right) \right)^3} \prod_{a=1}^3 \prod_{i,j=1}^{2n+1} \mathcal{I}_{\text{chir}}^{\mathcal{N}=1} \left((pq)^{\frac{1}{3}} \frac{z_i^{(a)}}{z_j^{(a)}}; p = q^2, q \right) \\ &\times \prod_{i,j=1}^{2n+1} \mathcal{I}_{\text{chir}}^{\mathcal{N}=1} \left((pq)^{\frac{1}{3}} f_2^{-1} \frac{z_i^{(1)}}{z_j^{(3)}}; p = q^2, q \right) \mathcal{I}_{\text{chir}}^{\mathcal{N}=1} \left((pq)^{\frac{1}{3}} f_2 \frac{z_i^{(3)}}{z_j^{(1)}}; p = q^2, q \right) \\ &\times \prod_{i,j=1}^{2n+1} \mathcal{I}_{\text{chir}}^{\mathcal{N}=1} \left((pq)^{\frac{1}{3}} f_1^{-1} \frac{z_i^{(2)}}{z_j^{(1)}}; p = q^2, q \right) \mathcal{I}_{\text{chir}}^{\mathcal{N}=1} \left((pq)^{\frac{1}{3}} f_1 \frac{z_i^{(1)}}{z_j^{(2)}}; p = q^2, q \right) \\ &\times \prod_{i,j=1}^{2n+1} \mathcal{I}_{\text{chir}}^{\mathcal{N}=1} \left((pq)^{\frac{1}{3}} \frac{f_1 z_i^{(3)}}{f_2 z_j^{(2)}}; p = q^2, q \right) \mathcal{I}_{\text{chir}}^{\mathcal{N}=1} \left((pq)^{\frac{1}{3}} \frac{f_2 z_i^{(2)}}{f_1 z_j^{(3)}}; p = q^2, q \right) \\ &= \mathcal{I}_{\text{necklace}}(f_1, f_2, p = q^2, q). \end{aligned} \quad (5.109)$$

5.5 Outlook

In this chapter, we have proposed new S-confining theories both in $3d$ and $4d$. We have then used these results to explain and generalize the SUSY enhancement appearing in [213]. The $3d$ perspective also suggests that many examples of $4d$ susy enhancements can be produced in a similar way that we did. Essentially by replacing the chiral fields of a $4d$ $\mathcal{N} = 2$ theory by one or multiple copies of $D_2(SU(\text{odd}))$ theories of which (part of) the global symmetry is gauged in an $\mathcal{N} = 1$ fashion. It would be nice to work out other examples in details.

Appendix A

Superpotential of Section 3.2.1 in frame \mathcal{T}_k

In this appendix, we will obtain the form of the $USp(2N)$ with one antisymmetric and 6 fundamentals, studied in Section 3.2.1, after k iterations of deconfinement/confinement. What is complicated is to keep track of the superpotential terms. We will do it in several steps. The key ingredient is to follow terms with the field O_p because we know how they start to appear. For example, when we go from the frame \mathcal{T}_0 to the frame \mathcal{T}_1 , the confining Pfaffian superpotential has created 2 terms containing the field O_1 : $\varepsilon_{2N-2} \varepsilon_5 [A_1^{N-2} Q_1^2 M_1 O_1 + A_1^{N-3} Q_1^4 O_1]$. But it is true more generally, when we go from the frame $\mathcal{T}_{(p-1)}$ to \mathcal{T}_p the confining Pfaffian superpotential creates 2 terms with the field O_p : $\varepsilon_{2N-2p} \varepsilon_5 [A_p^{N-p-1} Q_p^2 M_p O_p + A_p^{N-p-2} Q_p^4 O_p]$.

So let us call $\Theta_{(p)}$ all the terms containing O_p . As a first step, we need to understand what is $\Theta_{(p)}$ in a frame \mathcal{T}_k . Let us see how it is working for $\Theta_{(1)}$. In other words, we have to study the evolution of the two terms in \mathcal{T}_1 .

- $\varepsilon_{2N-2} \varepsilon_5 [A_1^{N-2} Q_1^2 M_1 O_1]$: It is easy to follow the evolution of this term. Indeed after 1 iteration it gives

$$\text{In } \mathcal{T}_2 : \varepsilon_{2N-4} \varepsilon_5 [\cancel{A_2^{N-2} M_2 M_1 O_1} + A_2^{N-3} Q_2^2 M_1 O_1]$$

The first term is killed by the chiral ring stability argument near (3.5). To get the second, one power of the antisymmetric A_1 has been used with Q_1^2 to produce Q_2^2 . We can repeat this k -times and we get

$$\text{In } \mathcal{T}_k : \varepsilon_{2N-2k} \varepsilon_5 [A_k^{N-k-1} Q_k^2 M_1 O_1]$$

- $\varepsilon_{2N-2} \varepsilon_5 [A_1^{N-3} Q_1^4 O_1]$: this term is trickier to keep track. After 1 iteration it produces

$$\text{In } \mathcal{T}_2 : \varepsilon_{2N-6} \varepsilon_5 \left[\cancel{A_2^{N-3} M_2^2 O_1} + A_2^{N-4} \underset{\star_1}{Q_2^2} M_2 O_1 + A_2^{N-5} \underset{\star_2}{Q_2^4} O_1 \right]$$

Once again the first term vanishes due to chiral ring stability. The term \star_1 has been obtained by using one power of A_1 in combination with Q_1^2 to produce Q_2^2 and Q_1^2 produces M_2 . It is of the same kind as the one previously studied. Therefore \star_1 produces in \mathcal{T}_k

$$\text{In } \mathcal{T}_k : \varepsilon_{2N-2k-2} \varepsilon_5 [A_k^{N-k-2} Q_k^2 M_2 O_1]$$

The term \star_2 has been produced by using two powers of A_1 with Q_1^4 to get Q_2^4 . It will once again produce 3 terms in \mathcal{T}_3 : 1 killed by chiral ring stability, 1 with Q_3^2 and one less power of the antisymmetric and 1 with Q_3^4 and two less power of the antisymmetric.

Therefore in \mathcal{T}_k , \star_2 produces a sum of terms with Q_k^2 and only one term with Q_k^4 . The first term in the sum is: $\varepsilon_{2N-2k-4} \varepsilon_5 [A_k^{N-k-3} Q_k^2 M_3 O_1]$ and the last one is:

$\varepsilon_{2N-4k+2} \varepsilon_5 [A_k^{N-2k} Q_k^2 M_k O_1]$ and there are all the terms in between. The term with Q_k^4 is given by: $\varepsilon_{2N-4k+2} \varepsilon_5 [A_k^{N-2k-1} Q_k^4 O_1]$. So the term \star_2 produces

$$\text{In } \mathcal{T}_k : \varepsilon_{2N-4k+2} \varepsilon_5 [A_k^{N-2k-1} Q_k^4 O_1] + \sum_{i=3}^k \varepsilon_{2N-2k-2i+2} \varepsilon_5 [A_k^{N-k-i} Q_k^2 M_i O_1]$$

The last result is valid until $N-2k-1 \geq 0$, which correspond to the power of the antisymmetric field in the term with Q_k^4 . Since k should be an integer, it should satisfy: $k \leq \lfloor \frac{N-1}{2} \rfloor$.

To summarize: $\Theta_{(1)}$ in the frame \mathcal{T}_k with $1 \leq k \leq \lfloor \frac{N-1}{2} \rfloor$ is given by

$$\Theta_{(1)} = \varepsilon_{2N-4k+2} \varepsilon_5 [A_k^{N-2k-1} Q_k^4 O_1] + \sum_{i=1}^k \varepsilon_{2N-2k-2i+2} \varepsilon_5 [A_k^{N-k-i} Q_k^2 M_i O_1]$$

Applying the same reasoning, it is not complicated to get the expression for the generic case: $\Theta_{(p)}$ in the frame \mathcal{T}_k with $p \leq k \leq k_{max}^{(p)} \equiv \lfloor \frac{N+p-2}{2} \rfloor$ is

$$\Theta_{(p)} = \varepsilon_{2N-4k+2p} \varepsilon_5 [A_k^{N-2k-2+p} Q_k^4 O_p] + \sum_{i=p}^k \varepsilon_{2N-2k-2i+2p} \varepsilon_5 [A_k^{N-k-i-1+p} Q_k^2 M_i O_p] \quad (\text{A.1})$$

The value of $k_{max}^{(p)}$ is obtained by requiring that the power of A_k , in the term with Q_k^4 , is positive. This finishes the first step.

The second step is to determine the evolution of $\Theta_{(p)}$ from $\mathcal{T}_{k_{max}^{(p)}}$ to the end \mathcal{T}_{N-1} and in a general frame in between. It will be useful to distinguish when the combination that enters in $k_{max}^{(p)}$: $N+p-2$ is even or odd.

- $\varepsilon_{2N-4k+2p} \varepsilon_5 [A_k^{N-2k-2+p} Q_k^4 O_p]$:

1. Case: $N+p-2$ even: $k_{max}^{(p)} = \frac{N+p-2}{2}$

$$\text{In } \mathcal{T}_{k_{max}^{(p)}} : \varepsilon_5 [Q_{k_{max}^{(p)}}^4 O_p]$$

$$\text{In } \mathcal{T}_{k_{max}^{(p)}+1+t} : \varepsilon_5 [M_{k_{max}^{(p)}+1}^2 O_p] \quad t \geq 0 \quad (\text{A.2})$$

2. Case: $N+p-2$ odd: $k_{max}^{(p)} = \frac{N+p-3}{2}$

$$\text{In } \mathcal{T}_{k_{max}^{(p)}} : \varepsilon_2 \varepsilon_5 [A_{k_{max}^{(p)}} Q_{k_{max}^{(p)}}^4 O_p]$$

$$\text{In } \mathcal{T}_{k_{max}^{(p)}+1} : \varepsilon_5 [M_{k_{max}^{(p)}+1} Q_{k_{max}^{(p)}+1}^2 O_p] \quad (\text{A.3})$$

$$\text{In } \mathcal{T}_{k_{max}^{(p)}+2+t} : \varepsilon_5 [M_{k_{max}^{(p)}+1} M_{k_{max}^{(p)}+2} O_p] \quad t \geq 0 \quad (\text{A.4})$$

- $\sum_{i=p}^k \varepsilon_{2N-2k-2i+2p} \varepsilon_5 [A_k^{N-k-i-1+p} Q_k^2 M_i O_p]$:

1. Case: $N + p - 2$ even: $k_{max}^{(p)} = \frac{N+p-2}{2}$

$$\begin{aligned}
& \text{In } \mathcal{T}_{k_{max}^{(p)}} : \sum_{i=p}^{k_{max}^{(p)}} \varepsilon_{2k_{max}^{(p)}+4-2i} \varepsilon_5 \left[A_{k_{max}^{(p)}}^{k_{max}^{(p)}+1-i} Q_{k_{max}^{(p)}}^2 M_i O_p \right] \\
& \text{In } \mathcal{T}_{k_{max}^{(p)}+1} : \sum_{i=p}^{k_{max}^{(p)}} \varepsilon_{2k_{max}^{(p)}+2-2i} \varepsilon_5 \left[A_{k_{max}^{(p)}+1}^{k_{max}^{(p)}-i} Q_{k_{max}^{(p)}+1}^2 M_i O_p \right] \\
& \text{In } \mathcal{T}_{k_{max}^{(p)}+2} : \varepsilon_5 \left[M_{k_{max}^{(p)}} M_{k_{max}^{(p)}+2} O_p \right] + \sum_{i=p}^{k_{max}^{(p)}-1} \varepsilon_{2k_{max}^{(p)}-2i} \varepsilon_5 \left[A_{k_{max}^{(p)}+2}^{k_{max}^{(p)}-1-i} Q_{k_{max}^{(p)}+2}^2 M_i O_p \right] \\
& \quad \vdots \\
& \text{In } \mathcal{T}_{k_{max}^{(p)}+1+t} : \sum_{i=1}^t \varepsilon_5 \left[M_{k_{max}^{(p)}+1-i} M_{k_{max}^{(p)}+1+i} O_p \right] \quad t = 0, \dots, k_{max}^{(p)} - p \\
& \quad + \sum_{i=p}^{k_{max}^{(p)}-t} \varepsilon_{2k_{max}^{(p)}+2-2i-2t} \varepsilon_5 \left[A_{k_{max}^{(p)}+1+t}^{k_{max}^{(p)}-t-i} Q_{k_{max}^{(p)}+1+t}^2 M_i O_p \right] \tag{A.5}
\end{aligned}$$

Notice that $2k_{max}^{(p)} + 1 - p = N - 1$. So we have the expression up to the end.

2. Case: $N + p - 2$ odd: $k_{max}^{(p)} = \frac{N+p-3}{2}$

$$\begin{aligned}
& \text{In } \mathcal{T}_{k_{max}^{(p)}} : \sum_{i=p}^{k_{max}^{(p)}} \varepsilon_{2k_{max}^{(p)}+6-2i} \varepsilon_5 \left[A_{k_{max}^{(p)}}^{k_{max}^{(p)}+2-i} Q_{k_{max}^{(p)}}^2 M_i O_p \right] \\
& \text{In } \mathcal{T}_{k_{max}^{(p)}+1} : \sum_{i=p}^{k_{max}^{(p)}} \varepsilon_{2k_{max}^{(p)}+4-2i} \varepsilon_5 \left[A_{k_{max}^{(p)}+1}^{k_{max}^{(p)}+1-i} Q_{k_{max}^{(p)}+1}^2 M_i O_p \right] \tag{A.6}
\end{aligned}$$

$$\begin{aligned}
& \text{In } \mathcal{T}_{k_{max}^{(p)}+2} : \sum_{i=p}^{k_{max}^{(p)}} \varepsilon_{2k_{max}^{(p)}+2-2i} \varepsilon_5 \left[A_{k_{max}^{(p)}+2}^{k_{max}^{(p)}-i} Q_{k_{max}^{(p)}+2}^2 M_i O_p \right] \\
& \text{In } \mathcal{T}_{k_{max}^{(p)}+3} : \varepsilon_5 \left[M_{k_{max}^{(p)}} M_{k_{max}^{(p)}+3} O_p \right] + \sum_{i=p}^{k_{max}^{(p)}-1} \varepsilon_{2k_{max}^{(p)}-2i} \varepsilon_5 \left[A_{k_{max}^{(p)}+3}^{k_{max}^{(p)}-1-i} Q_{k_{max}^{(p)}+3}^2 M_i O_p \right] \\
& \quad \vdots \\
& \text{In } \mathcal{T}_{k_{max}^{(p)}+2+t} : \sum_{i=1}^t \varepsilon_5 \left[M_{k_{max}^{(p)}+1-i} M_{k_{max}^{(p)}+2+i} O_p \right] \quad t = 0, \dots, k_{max}^{(p)} - p \\
& \quad + \sum_{i=p}^{k_{max}^{(p)}-t} \varepsilon_{2k_{max}^{(p)}+2-2i-2t} \varepsilon_5 \left[A_{k_{max}^{(p)}+2+t}^{k_{max}^{(p)}-t-i} Q_{k_{max}^{(p)}+2+t}^2 M_i O_p \right] \tag{A.7}
\end{aligned}$$

Once again $2k_{max}^{(p)} + 2 - p = N - 1$. So we have the expression up to the end.

This finishes the second step. The third and last step is to combine all the previous ingredients to write the superpotential in a generic frame. So let us fix k ($1 \leq k \leq N - 1$) we want the superpotential in \mathcal{T}_k . As we said it contains terms with O_p with $1 \leq p \leq k$. Also, depending on

p , there are two kinds of terms depending on whether $k_{max}^{(p)}$ is greater or smaller than k . The terms with $M^2 O_p$ & Q_k^2 as in (A.5)-(A.7) that we call terms A and the terms with Q_k^4 & Q_k^2 as in (A.1) that we call terms B. Let us call p_* , the precise p that is at the junction between the terms A and B. It is given by

$$\frac{N + p_* - 2}{2} \stackrel{!}{=} k \quad \Rightarrow \quad p_* = 2k + 2 - N \quad (\text{A.8})$$

Therefore obviously $k_{max}^{(p_*)} = k$. Then for $p \geq p_*$: $k_{max}^{(p)} = \lfloor \frac{N+p-2}{2} \rfloor \geq k$ and for $p < p_*$: $k_{max}^{(p)} < k$ which is what we wanted. To recap, for $1 \leq p \leq p_* - 1$ we have terms A and for $p_* \leq p \leq k$ we have terms B. So the superpotential takes the following form

$$W_k = H(-p_*) \underbrace{\sum_{p=1}^k \Theta_{(p)}}_B + H(p_* - \varepsilon) \left(\underbrace{\sum_{p=1}^{p_*-1} \Theta_{(p)}}_A + \underbrace{\sum_{p=p_*}^k \Theta_{(p)}}_B \right) \quad (\text{A.9})$$

We have included the Heavyside step function: $H(x) = \begin{cases} 1 & \text{if } x \geq 0 \\ 0 & \text{if } x < 0 \end{cases}$ to treat also the case $p_* \leq 0$. ε is a small positive quantity ($\ll 1$) to avoid double counting in the case $p_* = 0$. Now let us look in turn at terms A and B.

Terms B: By definition they satisfy $p \leq k \leq k_{max}^{(p)} \forall p \in B \equiv \forall p \geq p_*$. In this case it is easy and $\Theta_{(p)}$ is given by (A.1).

Terms A: By definition we have $k > k_{max}^{(p)} \forall p \in A \equiv \forall p < p_*$. It is more complicated in this case. The first thing to notice is that $N + p_* - 2 (= 2k)$ is necessarily even. Equivalently we can say that p_* has the same parity as N .

For $p = p_* - 1$: $k_{max}^{(p_*-1)} = \lfloor \frac{N+p_*-2-1}{2} \rfloor = \lfloor k + \frac{-1}{2} \rfloor = k - 1$. So in the frame \mathcal{T}_k we are 1 frame above $k_{max}^{(p_*-1)}$. In addition $N + (p_* - 1) - 2$ is odd therefore we are in the situation of (A.3) and (A.6). Conclusion $\Theta_{(p_*-1)}$ is given by

$$\Theta_{(p_*-1)} = \varepsilon_5 [M_k Q_k^2 O_{p_*-1}] + \sum_{i=p_*-1}^{k-1} \varepsilon_{2k+2-2i} \varepsilon_5 [A_k^{k-i} Q_k^2 M_i O_{p_*-1}] \quad (\text{A.10})$$

Then we go on. For $p = p_* - 1 - t$: $k_{max}^{(p_*-1-t)} = k + \lfloor \frac{-1-t}{2} \rfloor$ and $t = 1, \dots, p_* - 2$. In addition $N + (p_* - 1 - t) - 2$ has the opposite parity of t . therefore to continue and use our (A.5) and (A.7) we should separate between the odd and even value of t . That is, we rewrite the sum A as

$$\sum_{p=1}^{p_*-1} \Theta_{(p)} = \Theta_{(p_*-1)} + \sum_{t_{odd}=1}^{t_{odd}^{max}} \underbrace{\Theta_{(p_*-1-t_{odd})}}_{\text{Even parity}} + \sum_{t_{even}=2}^{t_{even}^{max}} \underbrace{\Theta_{(p_*-1-t_{even})}}_{\text{Odd parity}} \quad (\text{A.11})$$

Where the “ \sum' ” means $t_{min}, t_{min} + 2, t_{min} + 4, \dots$. It is not complicated to get the expression for t_{odd}^{max} and t_{even}^{max} . They are given by $t_{odd}^{max} = 2 \lceil \frac{p_*}{2} \rceil - 3$ and $t_{even}^{max} = 2 \lfloor \frac{p_*}{2} \rfloor - 2$.

Now $\Theta_{(p_\star-1-t_{\text{odd}})}$ in \mathcal{T}_k is given by (A.2) and (A.5). To use these formulas we need to do the following translation: $k \stackrel{!}{=} k_{\text{max}}^{(p_\star-1-t_{\text{odd}})} + 1 + t = k - \frac{1+t_{\text{odd}}}{2} + 1 + t \Rightarrow t = \frac{1+t_{\text{odd}}}{2} - 1$. Also $k_{\text{max}}^{p_\star-1-t_{\text{odd}}} - t = k + 1 - (1 + t_{\text{odd}}) = k - t_{\text{odd}}$. So

$$\begin{aligned} \Theta_{(p_\star-1-t_{\text{odd}})} &= \sum_{i=0}^{\frac{1+t_{\text{odd}}}{2}-1} \varepsilon_5 \left[M_{k-\frac{1+t_{\text{odd}}}{2}+1-i} M_{k-\frac{1+t_{\text{odd}}}{2}+1+i} O_{p_\star-1-t_{\text{odd}}} \right] \\ &\quad + \sum_{i=p_\star-1-t_{\text{odd}}}^{k-t_{\text{odd}}} \varepsilon_{2k+2-2i-2t_{\text{odd}}} \varepsilon_5 \left[A_k^{k-t_{\text{odd}}-i} Q_k^2 M_i O_{p_\star-1-t_{\text{odd}}} \right] \end{aligned} \quad (\text{A.12})$$

Similarly, $\Theta_{(p_\star-1-t_{\text{even}})}$ in \mathcal{T}_k is found using (A.4) and (A.7). Once again to use the formula we need to impose : $k \stackrel{!}{=} k_{\text{max}}^{(p_\star-1-t_{\text{even}})} + 2 + t = k - \frac{t_{\text{even}}}{2} + 1 + t \Rightarrow t = \frac{t_{\text{even}}}{2} - 1$. Also $k_{\text{max}}^{p_\star-1-t_{\text{even}}} - t = k - t_{\text{even}}$. So

$$\begin{aligned} \Theta_{(p_\star-1-t_{\text{even}})} &= \sum_{i=0}^{\frac{t_{\text{even}}}{2}-1} \varepsilon_5 \left[M_{k-\frac{t_{\text{even}}}{2}-i} M_{k-\frac{t_{\text{even}}}{2}+1+i} O_{p_\star-1-t_{\text{even}}} \right] \\ &\quad + \sum_{i=p_\star-1-t_{\text{even}}}^{k-t_{\text{even}}} \varepsilon_{2k+2-2i-2t_{\text{even}}} \varepsilon_5 \left[A_k^{k-t_{\text{even}}-i} Q_k^2 M_i O_{p_\star-1-t_{\text{even}}} \right] \end{aligned} \quad (\text{A.13})$$

Combining all results, the superpotential in \mathcal{T}_k is

$$\begin{aligned} W_k &= H(-p_\star) \sum_{p=1}^k \left(\sum_{i=p}^k \varepsilon_{2N-2k-2i+2p} \varepsilon_5 \left[A_k^{N-k-i-1+p} Q_k^2 M_i O_p \right] \right. \\ &\quad \left. + \varepsilon_{2N-4k+2p} \varepsilon_5 \left[A_k^{N-2k-2+p} Q_k^4 O_p \right] \right) + H(p_\star - \varepsilon) \sum_{p=p_\star}^k \left(\varepsilon_{2N-4k+2p} \varepsilon_5 \left[A_k^{N-2k-2+p} Q_k^4 O_p \right] \right. \\ &\quad \left. + \sum_{i=p}^k \varepsilon_{2N-2k-2i+2p} \varepsilon_5 \left[A_k^{N-k-i-1+p} Q_k^2 M_i O_p \right] \right) \\ &\quad + H(p_\star - 1 - \varepsilon) \left(\varepsilon_5 \left[M_k Q_k^2 O_{p_\star-1} \right] + \sum_{i=p_\star-1}^{k-1} \varepsilon_{2k+2-2i} \varepsilon_5 \left[A_k^{k-i} Q_k^2 M_i O_{p_\star-1} \right] \right) \\ &\quad + H(p_\star - 2 - \varepsilon) \sum_{t_{\text{odd}}=1}^{2\lceil \frac{p_\star}{2} \rceil - 3} \left(\sum_{i=0}^{\frac{1+t_{\text{odd}}}{2}-1} \varepsilon_5 \left[M_{k-\frac{1+t_{\text{odd}}}{2}+1-i} M_{k-\frac{1+t_{\text{odd}}}{2}+1+i} O_{p_\star-1-t_{\text{odd}}} \right] \right. \\ &\quad \left. + \sum_{i=p_\star-1-t_{\text{odd}}}^{k-t_{\text{odd}}} \varepsilon_{2k+2-2i-2t_{\text{odd}}} \varepsilon_5 \left[A_k^{k-t_{\text{odd}}-i} Q_k^2 M_i O_{p_\star-1-t_{\text{odd}}} \right] \right) \\ &\quad + H(p_\star - 3 - \varepsilon) \sum_{t_{\text{even}}=2}^{2\lfloor \frac{p_\star}{2} \rfloor - 2} \left(\sum_{i=0}^{\frac{t_{\text{even}}}{2}-1} \varepsilon_5 \left[M_{k-\frac{t_{\text{even}}}{2}-i} M_{k-\frac{t_{\text{even}}}{2}+1+i} O_{p_\star-1-t_{\text{even}}} \right] \right. \\ &\quad \left. + \sum_{i=p_\star-1-t_{\text{even}}}^{k-t_{\text{even}}} \varepsilon_{2k+2-2i-2t_{\text{even}}} \varepsilon_5 \left[A_k^{k-t_{\text{even}}-i} Q_k^2 M_i O_{p_\star-1-t_{\text{even}}} \right] \right) \end{aligned} \quad (\text{A.14})$$

By renaming indices it is possible to write W_k as

$$\begin{aligned}
W_k &= H(-p_\star) \sum_{p=1}^k \left(\sum_{i=p}^k \varepsilon_{2N-2k-2i+2p} \varepsilon_5 \left[A_k^{N-k-i-1+p} Q_k^2 M_i O_p \right] \right. \\
&+ \left. \varepsilon_{2N-4k+2p} \varepsilon_5 \left[A_k^{N-2k-2+p} Q_k^4 O_p \right] \right) + H(p_\star - \varepsilon) \sum_{p=p_\star}^k \left(\varepsilon_{2N-4k+2p} \varepsilon_5 \left[A_k^{N-2k-2+p} Q_k^4 O_p \right] \right. \\
&+ \left. \sum_{i=p}^k \varepsilon_{2N-2k-2i+2p} \varepsilon_5 \left[A_k^{N-k-i-1+p} Q_k^2 M_i O_p \right] \right) \\
&+ H(p_\star - 1 - \varepsilon) \left(\varepsilon_5 \left[M_k Q_k^2 O_{p_\star-1} \right] + \sum_{i=p_\star-1}^{k-1} \varepsilon_{2k+2-2i} \varepsilon_5 \left[A_k^{k-i} Q_k^2 M_i O_{p_\star-1} \right] \right) \\
&+ H(p_\star - 2 - \varepsilon) \left(\sum_{l=N-2\lceil \frac{N}{2} \rceil + 2}^{2k-N} \left(\sum_{j=\frac{N+l}{2}}^{N+l-k} \varepsilon_5 \left[M_j M_{N+l-j} O_l \right] \right. \right. \\
&\quad \left. \left. + \sum_{i=l}^{N+l-k-1} \varepsilon_{2N+2l-2i-2k} \varepsilon_5 \left[A_k^{N+l-i-k-1} Q_k^2 M_i O_l \right] \right) \right) \\
&+ H(p_\star - 3 - \varepsilon) \left(\sum_{m=N-2\lfloor \frac{N}{2} \rfloor + 1}^{2k-N-1} \left(\sum_{j=\frac{N+m-1}{2}}^{N+m-k-1} \varepsilon_5 \left[M_j M_{N+m-j} O_m \right] \right. \right. \\
&\quad \left. \left. + \sum_{i=m}^{N+m-k-1} \varepsilon_{2N+2m-2i-2k} \varepsilon_5 \left[A_k^{N+m-k-i-1} Q_k^2 M_i O_m \right] \right) \right) \tag{A.15}
\end{aligned}$$

Where we recall that “ \sum' ” means $l_{\min}, l_{\min} + 2, l_{\min} + 4, \dots$ and similar for m . We can do even better, $\star_1 + \star_2$ can combine together to give

$$\sum_{p=1}^{2k-N} \sum_{i=p}^{N+p-k-1} \varepsilon_{2N+2p-2i-2k} \varepsilon_5 \left[A_k^{N+p-k-i-1} Q_k^2 M_i O_p \right]$$

Less obviously, $\star_1 + \star_2$ can be packaged together. To do so we notice

- $\sum_{l=N-2\lceil \frac{N}{2} \rceil + 2}^{2k-N} + \sum_{m=N-2\lfloor \frac{N}{2} \rfloor + 1}^{2k-N-1} = \sum_{p=1}^{2k-N}$
- M_i, M_j and O_p that enter in the sum satisfy $i + j - p = N$
- In addition, the above i and j satisfy $N + p - k \leq i \leq j \leq k$
- All terms satisfying the above 3 criteria are present in the sums

Therefore $\star_1 + \star_2$ can be written

$$\sum_{p=1}^{2k-N} \sum_{N+p-k \leq i \leq j \leq k} \varepsilon_5 \left[M_i M_j O_p \right] \delta_{i+j-p, N}$$

So the last version of the superpotential is

$$\begin{aligned}
W_k = & H(-p_\star) \sum_{p=1}^k \left(\sum_{i=p}^k \varepsilon_{2N-2k-2i+2p} \varepsilon_5 \left[A_k^{N-k-i-1+p} Q_k^2 M_i O_p \right] \right. \\
& \left. + \varepsilon_{2N-4k+2p} \varepsilon_5 \left[A_k^{N-2k-2+p} Q_k^4 O_p \right] \right) + H(p_\star - \varepsilon) \sum_{p=p_\star}^k \left(\varepsilon_{2N-4k+2p} \varepsilon_5 \left[A_k^{N-2k-2+p} Q_k^4 O_p \right] \right. \\
& \left. + \sum_{i=p}^k \varepsilon_{2N-2k-2i+2p} \varepsilon_5 \left[A_k^{N-k-i-1+p} Q_k^2 M_i O_p \right] \right) \\
& + H(p_\star - 1 - \varepsilon) \left(\varepsilon_5 \left[M_k Q_k^2 O_{p_\star-1} \right] + \sum_{i=p_\star-1}^{k-1} \varepsilon_{2k+2-2i} \varepsilon_5 \left[A_k^{k-i} Q_k^2 M_i O_{p_\star-1} \right] \right) \\
& + H(p_\star - 2 - \varepsilon) \sum_{p=1}^{2k-N} \left(\sum_{i=p}^{N+p-k-1} \varepsilon_{2N+2p-2i-2k} \varepsilon_5 \left[A_k^{N+p-k-i-1} Q_k^2 M_i O_p \right] \right. \\
& \left. + \sum_{N+p-k \leq i \leq j \leq k} \varepsilon_5 \left[M_i M_j O_p \right] \delta_{i+j-p, N} \right)
\end{aligned} \tag{A.16}$$

with $p_\star = 2k + 2 - N$ and $H(x) = \begin{cases} 1 & \text{if } x \geq 0 \\ 0 & \text{if } x < 0 \end{cases}$

With W_k we can write the quiver of the theory in the frame \mathcal{T}_k

\mathcal{T}_k :

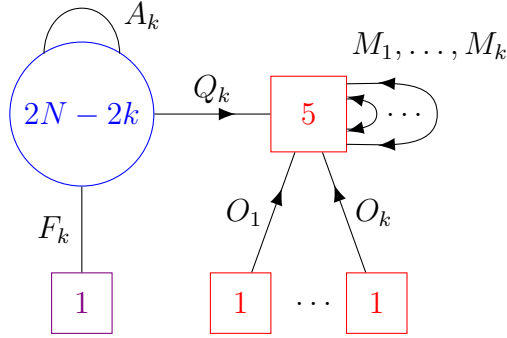

$$\mathcal{W} = \sum_{i=2}^{N-k} \text{Flip}[(A_k^i)] + W_k$$

(A.17)

To finish, when $k = N - 1$ then $p_\star = N$ and it is easy to see that (A.17) becomes (3.10).

Appendix B

R-charges and degenerate holomorphic operator ambiguity in the generic frame \mathcal{T}_k of Section 3.3.2

We start by writing the R-charges of the fields in the generic frame \mathcal{T}_k (3.104).

Fields	R-charges in \mathcal{T}_k
V_i	$5 - 2F + (N - \frac{5}{2} + \frac{3i}{2})R_A + (2F - 1)R_Q$
Flipper[$V_i B_i \dots B_{k-1} Q_k$]	$2F - 4 - (N - 2 + i)R_A - (2F - 2)R_Q$
Flipper[$B_i \dots B_{k-1} Q_k Q_k B_{k-1} \dots B_i$]	$2R_Q + (i - 1)R_A$
H_i	$(N - i + 1)R_A$
R_j	$2F - 3 - (N + \frac{3j}{2} - \frac{1}{2})R_A - (2F - 1)R_Q$
B_j	$\frac{1}{2}R_A$
A_j	$2 - R_A$
C_k	$1 - \frac{1}{2}R_A$
Q_k	$1 + \frac{1}{2}(1 - k)R_A$
Q_{k+1}	$R_Q + \frac{k}{2}R_A$
P_{k+1}	$2F - 4 - (2N - 2 + \frac{k}{2})R_A - (2F - 1)R_Q$
Φ	R_A

Table B.1: R-charges in the frame \mathcal{T}_k with $k = 1, \dots, N - 1$, $i = 1, \dots, k$ and $j = 1, \dots, k - 1$.

Now we want to find the degenerate operators that can couple to H_i , as we did in (3.83) in the case of $Usp(6)$. In order to so, we look at the R-charges of the operator $V_i B_i \dots B_{k-1} C_k P_{k+1}$ which is the natural candidate to be coupled to H_i . We find

$$R(V_i B_i \dots B_{k-1} C_k P_{k+1}) = 2 - (N - i + 1)R_A \quad (\text{B.1})$$

The potential degenerate operators should be a singlet under the non-abelian global symmetry and should have the same R-charges (B.1). We can build the degenerate operators from the fields V_a , B_b and R_c . Indeed, we start from V_m , then we put some B_b and end with R_n ($n \geq m$)¹.

¹We cannot end with V_{j+1} because the F-term equation of R_j sets the combination $B_j V_{j+1}$ to 0.

The form of these operators is then: $V_m B_m \dots B_{n-1} R_n$. The number of fields B is $n - m$. The R-charge is

$$R_{V_m} + (n - m)R_{B_b} + R_{R_n} = 2 - (2 + (n - m))R_A \quad (\text{B.2})$$

If we compare with (B.1), we find the following condition

$$n - m = N - i - 1 \quad (\text{B.3})$$

with $1 \leq m \leq n \leq k - 1$, $i = 1, \dots, k$ and $k = 1, \dots, N - 1$.

We can already make two remarks:

- For $i = 1$, the constraint becomes $n - m = N - 2$ but the maximal value of $n - m$ is $k - 2$ and k satisfies $k \leq N - 1$. We conclude that there is never a solution for $i = 1$. Therefore there is never a degenerate operator associated to H_1 .
- If $k = 1$ then n and m don't exist. Conclusion, in order to get degenerate operators we should have $N \geq 3$ which means that degenerate operators will pop up in frames with at least 3 gauge groups (which correspond to $k = 2$).

We can ask the more precise question: What is the first frame, $\mathcal{T}_{k_{min}}$, when some operators degenerate? In order to answer that we have to try to maximize the l.h.s of (B.3) and minimize the r.h.s. Therefore it is enough to look at $n = k_{min} - 1$, $m = 1$ and $i = k_{min}$ to determine k_{min} (it could also have degenerate operators in $\mathcal{T}_{k_{min}}$ not associated to $n = k_{min} - 1$, $m = 1$ and $i = k_{min}$). We obtain

$$k_{min} - 2 = N - k_{min} - 1 \quad \Rightarrow \quad k_{min} = \left\lceil \frac{N + 1}{2} \right\rceil \quad (\text{B.4})$$

So when we reach $\mathcal{T}_{k_{min}}$ we start having this issue of degenerate operators.

Now let us solve (B.3) in the case $k = N - 1$. In this case, $1 \leq m \leq n \leq N - 2$

$$\begin{aligned} i = 2 : & & n = N + m - 3 \\ & & \exists \text{ solution for } m = 1 \\ i = 3 : & & n = N + m - 4 \\ & & \exists \text{ solution for } m = 1, 2 \\ & & \vdots \\ i = N - 1 : & & n = m \\ & & \exists \text{ solution for } m = 1, \dots, N - 2 \end{aligned}$$

Conclusion, the degenerate operators (with respect to $V_i B_i \dots B_{N-2} C_{N-1} F_N$) that potentially coupled to H_i in \mathcal{T}_{N-1} are:

$$\begin{aligned} H_2 : & & V_1 B_1 \dots B_{N-3} R_{N-2} & & 1 \text{ operator} \\ H_3 : & & V_1 B_1 \dots B_{N-4} R_{N-3}, V_2 B_2 \dots B_{N-3} R_{N-2} & & 2 \text{ operators} \\ & & \vdots & & \\ H_{N-1} : & & V_1 R_1, V_2 R_2, \dots, V_{N-2} R_{N-2} & & N-2 \text{ operators} \end{aligned}$$

Finally, we can study the final frame \mathcal{T}_{Dec} . The R-charges are the following

Fields	R-charges in \mathcal{T}_{Dec}
v_i	$5 - 2F + (N - \frac{5}{2} + \frac{3i}{2})R_A + (2F - 1)R_Q$
Flipper[$v_i b_i \dots b_{N-1} q_N$]	$2F - 4 - (N - 2 + i)R_A - (2F - 2)R_Q$
Flipper[$b_i \dots b_{N-1} q_N q_N b_{N-1} \dots b_i$]	$2R_Q + (i - 1)R_A$
h_j	$(N - i + 1)R_A$
r_j	$2F - 3 - (N + \frac{3j}{2} - \frac{1}{2})R_A - (2F - 1)R_Q$
b_j	$\frac{1}{2}R_A$
a_j	$2 - R_A$
q_N	$1 - R_Q - \frac{1}{2}(N - 1)R_A$

Table B.2: R-charges in \mathcal{T}_{Dec} with $i = 1, \dots, N$ and $j = 1, \dots, N - 1$.

Now using the previous result for \mathcal{T}_{N-1} , we can summarize all the candidates to be coupled to h_i in the final frame \mathcal{T}_{Dec}

$h_1 :$	$v_1 b_1 \dots b_{N-2} r_{N-1}$	No degenerate operator
$h_2 :$	$v_1 b_1 \dots b_{N-3} r_{N-2}, v_2 b_2 \dots b_{N-2} r_{N-1}$	2 operators
$h_3 :$	$v_1 b_1 \dots b_{N-4} r_{N-3}, v_2 b_2 \dots b_{N-3} r_{N-2}, v_3 b_3 \dots b_{N-2} r_{N-1}$	3 operators
\vdots		
$h_{N-1} :$	$v_1 r_1, v_2 r_2, \dots, v_{N-2} r_{N-2}, v_{N-1} r_{N-1}$	N-1 operators

Now the question is obvious, which operator is the correct one?

In the special case of $F = 4$, we could use the same argument that we used in Section 3.3.1. It goes as follows. When we reach the frame $\mathcal{T}_{k_{min}}$ some operators become degenerate. In order to decide the correct operator, we start confining from the left (it is possible because in the case of $F = 4$ the gauge group becomes $Usp(2)$). Then at some point we will discover that using the F-term equation for H_1 (which is never associated to a degenerate operator as we saw) we can select the correct operator associated to some H_a (as in (3.85)). Then, the procedure is iterative meaning that we should re-use our previous results for H_a and do more and more re-confinement to select all the correct operators associated to the other H_b . All in all, we end up in the frame \mathcal{T}_{N-1} with the following superpotential term

$$\delta\mathcal{W}_{N-1} = H_1 V_1 B_1 \dots B_{N-2} C_{N-1} P_N + \sum_{i=2}^{N-1} H_i V_1 B_1 \dots B_{N-1-i} R_{N-i} \quad (\text{B.5})$$

which becomes in the final frame \mathcal{T}_{Dec}

$$\delta\mathcal{W}_{Dec} = \sum_{i=1}^{N-1} h_i v_1 b_1 \dots b_{N-1-i} r_{N-i} \quad (\text{B.6})$$

Unfortunately, in the case of $F > 4$ the previous argument fails because we cannot reconfine from the left. In this case we can deconfine the antisymmetric field A_1 but we didn't manage to find constraints and remove the degeneracy. Therefore, in this case the superpotential that we wrote in (3.106) and (3.107) are ambiguous. We wrote them with the results (B.5), (B.6) obtain in the case $F = 4$ but it is logically possible that they are wrong for $F > 4$.

Appendix C

Matching of 't Hooft anomaly matching

As explained in Section 2.4, 't Hooft anomalies are invariant along the RG flow. Their matching is therefore a good check of a duality statement. The formula used in this appendix have been taken from Section 2.4 and Section 2.5.

C.1 Matching of 't Hooft anomalies for the duality of Section 4.3.2

In this appendix we present the matching of the t'Hooft anomalies for the duality (4.70) that we report in C.1 for convenience. On both LHS and RHS of the duality, the theories have 4 $U(1)$'s global symmetries. The following charges assignments respect the constraints coming from ABJ anomalies and the superpotential terms. The matching of the t'Hooft anomalies are really non-trivial, especially the ones involving the $U(1)$'s symmetries, and relies on having the correct set of flipper fields.

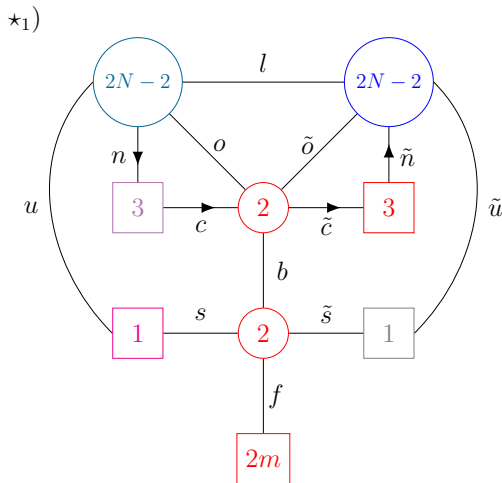

$$\mathcal{W} = 2 \text{Quartic} + 3 \text{Triangles} \\ + \text{Flip}[bb, c\tilde{c}, cb\tilde{s}, \tilde{c}bs, bsb\tilde{s}]$$

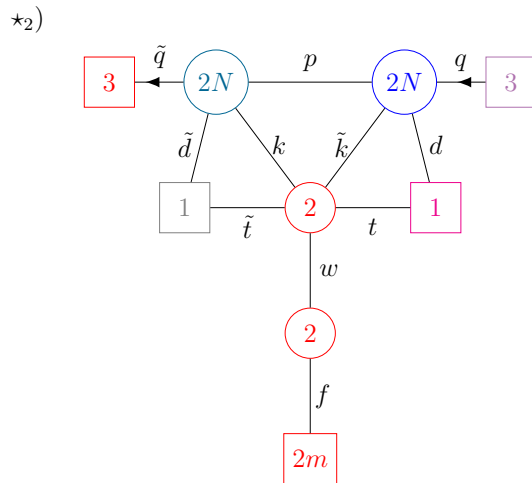

$$\mathcal{W} = 3 \text{Triangles} + \text{Flip}[ww] \\ + \sum_{i=0}^{N-1} \text{Flip}[q(pp)^i q; \tilde{q}(pp)^i \tilde{q}; q(pp)^i d; \tilde{q}(pp)^i \tilde{d}; \\ qp(pp)^i \tilde{q}; q\tilde{p}(pp)^i \tilde{d}; \tilde{q}p(pp)^i d; dp(pp)^i \tilde{d}] \quad (\text{C.1})$$

Fields LHS	$U(1)_1$	$U(1)_2$	$U(1)_3$	$U(1)_4$
f	0	0	$\frac{1}{2m}$	0
s	0	1	$-\frac{1}{2}$	$-\frac{1}{2}$
\tilde{s}	0	-1	$-\frac{1}{2}$	$-\frac{1}{2}$
b	0	0	0	$\frac{1}{2}$
u	-1	-2	$\frac{2N-1}{4N}$	$-\frac{1}{4N}$
\tilde{u}	1	2	$\frac{2N-1}{4N}$	$-\frac{1}{4N}$
c	$-\frac{2}{3}$	-1	$-\frac{N-1}{6N}$	$-\frac{2N-1}{6N}$
n	$-\frac{1}{3}$	0	$\frac{1}{3} \frac{2N-5}{4N}$	$\frac{4N-5}{12N}$
\tilde{n}	$\frac{1}{3}$	0	$\frac{1}{3} \frac{2N-5}{4N}$	$\frac{4N-5}{12N}$
o	1	1	$\frac{1}{4N}$	$\frac{1}{4N}$
\tilde{o}	-1	-1	$\frac{1}{4N}$	$\frac{1}{4N}$
l	0	0	$-\frac{1}{2N}$	$-\frac{1}{2N}$

Table C.1: $U(1)$'s charges of the fields in LHS of (C.1).

Fields RHS	$U(1)_1$	$U(1)_2$	$U(1)_3$	$U(1)_4$
f	0	0	$\frac{1}{2m}$	0
w	0	0	$-\frac{1}{2}$	0
t	0	-1	0	$-\frac{1}{2}$
\tilde{t}	0	1	0	$-\frac{1}{2}$
d	1	2	$-\frac{1}{4N}$	$\frac{2N-1}{4N}$
\tilde{d}	-1	-2	$-\frac{1}{4N}$	$\frac{2N-1}{4N}$
k	1	1	$\frac{1}{4N}$	$\frac{1}{4N}$
\tilde{k}	-1	-1	$\frac{1}{4N}$	$\frac{1}{4N}$
q	$\frac{1}{3}$	0	$\frac{4N-1}{12N}$	$\frac{2N-1}{12N}$
\tilde{q}	$-\frac{1}{3}$	0	$\frac{4N-1}{12N}$	$\frac{2N-1}{12N}$
p	0	0	$-\frac{1}{2N}$	$-\frac{1}{2N}$

Table C.2: $U(1)$'s charges of the fields in RHS of (C.1).

't Hooft anomalies involving non-abelian symmetries:

- LHS:

$$\text{tr}(SU(3)^3) = (2N-2)A(\square) + 2A(\bar{\square}) + 3A(\square) + A(\square) = 2N \quad (\text{C.2})$$

$$\text{tr}(SU(3)^3) = -2N \quad (\text{C.3})$$

$$\text{tr}(SU(2m)^3) = 2 \quad (\text{C.4})$$

• **RHS:**

$$\text{tr}(SU(3)^3) = 2NA(\bar{\square}) + N \left(A(\square) + A(\square) + 3A(\square) + A(\square) \right) = 2N \quad (\text{C.5})$$

$$\text{tr}(SU(3)^3) = -2N \quad (\text{C.6})$$

$$\text{tr}(SU(2m)^3) = 2 \quad (\text{C.7})$$

Where the group theoretic constants can be found in Table 2.3.

't Hooft anomalies involving abelian symmetries:

• **LHS:**

$$\text{tr}(SU(3)^2 U(1)_i) = (2N - 2) q_n^i \mu(\bar{\square}) + 2 q_c^i \mu(\square) - 3(q_c^i + q_{\bar{c}}^i) \mu(\bar{\square}) - (q_c^i + q_b^i + q_s^i) \mu(\bar{\square})$$

$$i = 1 : = -\frac{N}{3}$$

$$i = 2 : = 0$$

$$i = 3 : = \frac{2N + 1}{12}$$

$$i = 4 : = \frac{4N + 1}{12}$$

$$\text{tr}(SU(3)^2 U(1)_i) = (2N - 2) q_n^i \mu(\bar{\square}) + 2 q_{\bar{c}}^i \mu(\square) - 3(q_c^i + q_{\bar{c}}^i) \mu(\bar{\square}) - (q_{\bar{c}}^i + q_b^i + q_s^i) \mu(\bar{\square})$$

$$i = 1 : = \frac{N}{3}$$

$$i = 2 : = 0$$

$$i = 3 : = \frac{2N + 1}{12}$$

$$i = 4 : = \frac{4N + 1}{12}$$

Where the group theoretic constants can be found in Table 2.3.

Same kind of computations give for the linear anomalies:

$$\text{tr}(U(1)_1) = 0$$

$$\text{tr}(U(1)_2) = 0$$

$$\text{tr}(U(1)_3) = 2N + 2$$

$$\text{tr}(U(1)_4) = 2N - 1$$

• **RHS:**

$$\text{tr}(SU(3)^2 U(1)_i) = (2N) q_q^i \mu(\bar{\square}) - \sum_{j=0}^{N-1} \left[(2 q_q^j + 2j q_p^j) \mu(\square) + (q_q^j + 2j q_p^j + q_d^j) \mu(\square) \right. \\ \left. + 3(q_q^j + q_{\bar{q}}^j + (2j + 1) q_p^j) \mu(\square) + (q_q^j + q_{\bar{d}}^j + (2j + 1) q_p^j) \mu(\square) \right]$$

$$i = 1 : = -\frac{N}{3}$$

$$i = 2 : = 0$$

$$i = 3 : = \frac{2N + 1}{12}$$

$$i = 4 : = \frac{4N + 1}{12}$$

$$\begin{aligned}
\text{tr} (SU(3)^2 U(1)_i) &= (2N) q_q^i \mu(\square) - \sum_{j=0}^{N-1} \left[(2 q_q^j + 2j q_p^j) \mu(\bar{\square}) + (q_q^j + 2j q_p^j + q_d^j) \mu(\bar{\square}) \right. \\
&\quad \left. + 3(q_q^j + q_d^j + (2j+1) q_p^j) \mu(\square) + (q_q^j + q_d^j + (2j+1) q_p^j) \mu(\bar{\square}) \right] \\
i = 1 &: = \frac{N}{3} \\
i = 2 &: = 0 \\
i = 3 &: = \frac{2N+1}{12} \\
i = 4 &: = \frac{4N+1}{12}
\end{aligned}$$

$$\text{tr} (U(1)_1) = 0$$

$$\text{tr} (U(1)_2) = 0$$

$$\text{tr} (U(1)_3) = 2N + 2$$

$$\text{tr} (U(1)_4) = 2N - 1$$

We can indeed see the matching of the anomalies.

C.2 Matching of 't Hooft anomalies for the duality of Section 5.2

Similarly, in this Section we show the matching of the 't Hooft anomalies and the central charges of the different 4d S-confining theories presented in Section 5.2.

$\mathcal{U}_1[n]$

The first thing we compare on both sides is the central charges. On the gauge theory side, the formula (2.82) and (2.83) give

$$a_{\text{l.h.s.}} = n(2n+1)a_0[2] + (n(2n-1)-1)a_0\left[\frac{4}{3}\right] + (4n+2)(2n)a_0\left[\frac{1}{3}\right] \quad (\text{C.8})$$

$$= \frac{1}{48} (8n^2 + 6n + 1) = a_0\left[\frac{2}{3}\right] (8n^2 + 6n + 1) , \quad (\text{C.9})$$

$$c_{\text{l.h.s.}} = n(2n+1)c_0[2] + (n(2n-1)-1)c_0\left[\frac{4}{3}\right] + (4n+2)(2n)c_0\left[\frac{1}{3}\right] \quad (\text{C.10})$$

$$= \frac{1}{24} (8n^2 + 6n + 1) = c_0\left[\frac{2}{3}\right] (8n^2 + 6n + 1) . \quad (\text{C.11})$$

The first term is the contribution of the gauginos, the second is the contribution of the antisymmetric traceless field a and the last term comes from the fundamental p . The various contributions are written in terms of

On the WZ side, the central charges are given by

$$a_{\text{r.h.s.}} = (2n+1)(4n+1)a_0\left[\frac{2}{3}\right] = a_0\left[\frac{2}{3}\right] (8n^2 + 6n + 1) , \quad (\text{C.12})$$

$$c_{\text{r.h.s.}} = (2n+1)(4n+1)c_0 \left[\frac{2}{3} \right] = c_0 \left[\frac{2}{3} \right] (8n^2 + 6n + 1) . \quad (\text{C.13})$$

In the first equality we have the contribution of the $USp(4n+2)$ antisymmetric A with the trace part. We can indeed see the matching between (C.9)-(C.12) and (C.11)-(C.13).

We can also consider the 't Hooft anomalies for the global symmetries

$$\text{Tr} \left(U(1)_R \text{USp}(4n+2)^2 \right)_{\text{l.h.s.}} = \left(\frac{1}{3} - 1 \right) 2n \times \frac{1}{2} = -\frac{2n}{3} , \quad (\text{C.14})$$

$$\text{Tr} \left(U(1)_R \text{USp}(4n+2)^2 \right)_{\text{r.h.s.}} = \left(\frac{2}{3} - 1 \right) 2n = -\frac{2n}{3} , \quad (\text{C.15})$$

where we used the values of Dynkin indices reported in Table 2.4.

$\mathcal{O}_1[n]$

Once again we can start by computing the central charges of the gauge theory

$$a_{\text{l.h.s.}} = \frac{1}{2}n(n-1)a_0[2] + \frac{1}{2}n(n+1) - 1 a_0 \left[\frac{4}{3} \right] + n(2n-2)a_0 \left[\frac{1}{3} \right] \quad (\text{C.16})$$

$$= \frac{1}{48} (2n^2 - 3n + 1) = a_0 \left[\frac{2}{3} \right] (2n^2 - 3n + 1) , \quad (\text{C.17})$$

$$c_{\text{l.h.s.}} = \frac{1}{2}n(n-1)c_0[2] + \frac{1}{2}n(n+1) - 1 c_0 \left[\frac{4}{3} \right] + n(2n-2)c_0 \left[\frac{1}{3} \right] \quad (\text{C.18})$$

$$= \frac{1}{24} (2n^2 - 3n + 1) = c_0 \left[\frac{2}{3} \right] (2n^2 - 3n + 1) . \quad (\text{C.19})$$

The first term is the contribution of the gauginos, the second is the contribution of the symmetric traceless field s and the last term comes from the chiral p in the vector representation.

On the WZ side, the central charges are given by

$$a_{\text{r.h.s.}} = (n-1)(2n-1)a_0 \left[\frac{2}{3} \right] = a_0 \left[\frac{2}{3} \right] (2n^2 - 3n + 1) , \quad (\text{C.20})$$

$$c_{\text{r.h.s.}} = (n-1)(2n-1)c_0 \left[\frac{2}{3} \right] = c_0 \left[\frac{2}{3} \right] (2n^2 - 3n + 1) . \quad (\text{C.21})$$

We can indeed see the matching between (C.17)-(C.20) and (C.19)-(C.21).

We can also consider other 't Hooft anomalies

$$\text{Tr} \left(U(1)_R \text{SO}(2n-2)^2 \right)_{\text{l.h.s.}} = \left(\frac{1}{3} - 1 \right) n \times 1 = -\frac{2n}{3} \quad (\text{C.22})$$

$$\text{Tr} \left(U(1)_R \text{SO}(2n-2)^2 \right)_{\text{r.h.s.}} = \left(\frac{2}{3} - 1 \right) 2n = -\frac{2n}{3} , \quad (\text{C.23})$$

where we used the values of Dynkin indices reported in Table 2.5.

$\mathcal{U}_2[n, h]$

The central charges of the gauge theory are

$$a_{\text{l.h.s.}} = n(2n+1)a_0[2] + n(2n-1)a_0\left[\frac{2}{3}\right] + 2n(2n+8-4h)a_0\left[\frac{2}{3}\right] \quad (\text{C.24})$$

$$\begin{aligned} &+ (2h)(2n)a_0\left[\frac{h-n}{3h}\right] + h(2h-1)a_0\left[2-2\frac{h-n}{3h}\right] + h(2h-1)a_0\left[2-2\frac{h-n}{3h}-\frac{2}{3}\right] \\ &+ 2h(2n+8-4h)a_0\left[2-\frac{h-n}{3h}-\frac{2}{3}\right] = 0, \end{aligned} \quad (\text{C.25})$$

$$c_{\text{l.h.s.}} = n(2n+1)c_0[2] + n(2n-1)c_0\left[\frac{2}{3}\right] + 2n(2n+8-4h)c_0\left[\frac{2}{3}\right] \quad (\text{C.26})$$

$$\begin{aligned} &+ (2h)(2n)c_0\left[\frac{h-n}{3h}\right] + h(2h-1)c_0\left[2-2\frac{h-n}{3h}\right] + h(2h-1)c_0\left[2-2\frac{h-n}{3h}-\frac{2}{3}\right] \\ &+ 2h(2n+8-4h)c_0\left[2-\frac{h-n}{3h}-\frac{2}{3}\right] = 0. \end{aligned} \quad (\text{C.27})$$

We can see that they vanish, in accordance with our claim that the theory is trivial in the IR.

Also the other 't Hooft anomalies vanish

$$\begin{aligned} \text{Tr}(\text{U}(1)_R \text{SU}(2h)^2) &= \left[2n\left(\frac{h-n}{3h}-1\right) + (2n+8-4h)\left(2-\frac{2}{3}-\frac{h-n}{3h}-1\right)\right] \times \frac{1}{2} \\ &+ \left[\left(2-2\frac{h-n}{3h}-1\right) + \left(2-\frac{2}{3}-2\frac{h-n}{3h}-1\right)\right] (h-1) = 0, \end{aligned} \quad (\text{C.28})$$

$$\text{Tr}(\text{U}(1)_R \text{USp}(2n+8-4h)^2) = \left[2n\left(\frac{2}{3}-1\right) + 2h\left(2-\frac{2}{3}-\frac{h-n}{3h}-1\right)\right] \times \frac{1}{2} = 0, \quad (\text{C.29})$$

$\mathcal{S}_2[n, h]$

The central charges of the gauge theory are

$$a_{\text{l.h.s.}} = \frac{1}{2}n(n-1)a_0[2] + \frac{1}{2}n(n+1)a_0\left[\frac{2}{3}\right] + n(n-8-2h)a_0\left[\frac{2}{3}\right] \quad (\text{C.30})$$

$$\begin{aligned} &+ hna_0\left[\frac{h-n}{3h}\right] + \frac{1}{2}h(h+1)a_0\left[2-2\frac{h-n}{3h}\right] + \frac{1}{2}h(h+1)a_0\left[2-2\frac{h-n}{3h}-\frac{2}{3}\right] \\ &+ h(n-8-2h)a_0\left[2-\frac{h-n}{3h}-\frac{2}{3}\right] = 0, \end{aligned} \quad (\text{C.31})$$

$$c_{\text{l.h.s.}} = \frac{1}{2}n(n-1)c_0[2] + \frac{1}{2}n(n+1)c_0\left[\frac{2}{3}\right] + n(n-8-2h)c_0\left[\frac{2}{3}\right] \quad (\text{C.32})$$

$$\begin{aligned} &+ hnc_0\left[\frac{h-n}{3h}\right] + \frac{1}{2}h(h+1)c_0\left[2-2\frac{h-n}{3h}\right] + \frac{1}{2}h(h+1)c_0\left[2-2\frac{h-n}{3h}-\frac{2}{3}\right] \\ &+ h(n-8-2h)c_0\left[2-\frac{h-n}{3h}-\frac{2}{3}\right] = 0. \end{aligned} \quad (\text{C.33})$$

The other 't Hooft anomalies are

$$\begin{aligned} \text{Tr}(\text{U}(1)_R \text{SU}(h)^2) &= \left[n\left(\frac{h-n}{3h}-1\right) + (n-8-2h)\left(2-\frac{2}{3}-\frac{h-n}{3h}-1\right)\right] \times \frac{1}{2} \\ &+ \left[\left(2-2\frac{h-n}{3h}-1\right) + \left(2-\frac{2}{3}-2\frac{h-n}{3h}-1\right)\right] \frac{h+2}{2} = 0, \end{aligned} \quad (\text{C.34})$$

$$\text{Tr}(\text{U}(1)_R (\text{SO}(n+8-2h))^2) = \left[n\left(\frac{2}{3}-1\right) + h\left(2-\frac{2}{3}-\frac{h-n}{3h}-1\right)\right] \times 1 = 0, \quad (\text{C.35})$$

$\mathcal{A}_2[n, h]$

The central charges are

$$a_{\text{l.h.s.}} = (n^2 - 1)a_0[2] + n^2 a_0\left[\frac{2}{3}\right] + 2n(n - 2h)a_0\left[\frac{2}{3}\right] \quad (\text{C.36})$$

$$\begin{aligned} &+ 2h n a_0\left[\frac{h-n}{3h}\right] + h^2 a_0\left[2 - 2\frac{h-n}{3h}\right] + h^2 a_0\left[2 - 2\frac{h-n}{3h} - \frac{2}{3}\right] \\ &+ 2h(n - 2h)a_0\left[2 - \frac{h-n}{3h} - \frac{2}{3}\right] \\ &= a_0[0] = a_{\text{r.h.s.}} \end{aligned} \quad (\text{C.37})$$

$$c_{\text{l.h.s.}} = (n^2 - 1)c_0[2] + n^2 c_0\left[\frac{2}{3}\right] + 2n(n - 2h)c_0\left[\frac{2}{3}\right] \quad (\text{C.38})$$

$$\begin{aligned} &+ 2h n c_0\left[\frac{h-n}{3h}\right] + h^2 c_0\left[2 - 2\frac{h-n}{3h}\right] + h^2 c_0\left[2 - 2\frac{h-n}{3h} - \frac{2}{3}\right] \\ &+ 2h(n - 2h)c_0\left[2 - \frac{h-n}{3h} - \frac{2}{3}\right] = c_0[0] = c_{\text{r.h.s.}} \end{aligned} \quad (\text{C.39})$$

Some other 't Hooft anomalies are

$$\begin{aligned} \text{Tr}(\text{U}(1)_{\text{R}} \text{SU}(h)_{\text{P}}^2) &= \text{Tr}(\text{U}(1)_{\text{R}} \text{SU}(h)_{\text{P}}^2) = n \left(\frac{h-n}{3h} - 1 \right) \\ &+ h \left(2 - 2\frac{h-n}{3h} - 1 \right) + h \left(2 - 2\frac{h-n}{3h} - \frac{2}{3} - 1 \right) + (n - 2h) \left(2 - \frac{2}{3} - \frac{h-n}{3h} - 1 \right) = 0, \end{aligned} \quad (\text{C.40})$$

$$\begin{aligned} \text{Tr}(\text{U}(1)_{\text{R}} \text{SU}(n - 2h)^2) &= \left[2n \left(\frac{2}{3} - 1 \right) + 2h \left(2 - \frac{2}{3} - \frac{h-n}{3h} - 1 \right) \right] \frac{1}{2} \\ &= 0 \end{aligned} \quad (\text{C.41})$$

Everything is compatible with the claim that in the IR the theory is given by 2 singlets of R-charge 0 and one of R-charge 2 which are uncharged under the non-abelian symmetries.

Appendix D

Deconfinement derivation for $\mathcal{U}_1[2]$

In this appendix we derive the S-confinement result $\mathcal{U}_1[n = 2]$. The first step is the same as in the general n case of Subsection 5.3.3. We have to split the 10 fundamental into $8 + 1 + 1$. We obtain the following quiver:

$$\begin{array}{c}
 \mathcal{U}_1[2] : \\
 \begin{array}{ccc}
 \begin{array}{c}
 \textcircled{4} \xrightarrow{a, \frac{4}{3}} \textcircled{10} \\
 \textcircled{4} \xrightarrow{\frac{1}{3}} \textcircled{10} \\
 \mathcal{W} = app
 \end{array}
 & \equiv &
 \begin{array}{c}
 \textcircled{4} \xrightarrow{a, \frac{4}{3}} \textcircled{8} \\
 \textcircled{4} \xrightarrow{\frac{1}{3}, p_1} \square{1} \\
 \textcircled{4} \xrightarrow{p_2, \frac{1}{3}} \square{1} \\
 \mathcal{W} = aqq + ap_1p_2
 \end{array}
 \end{array}
 \end{array}
 \tag{D.1}$$

As in the general n case, we deconfine the antisymmetric traceless field a so to get

$$\begin{array}{c}
 \begin{array}{ccccc}
 \textcircled{2} & \xrightarrow{b, \frac{2}{3}} & \textcircled{4} & \xrightarrow{q, \frac{1}{3}} & \textcircled{8} \\
 \textcircled{2} \xrightarrow{-\frac{1}{3}, v} \square{1} & \textcircled{2} \xrightarrow{-\frac{1}{3}, d} \square{1} & \textcircled{4} \xrightarrow{\frac{5}{3}, e} \square{1} & \textcircled{4} \xrightarrow{p_2, \frac{1}{3}} \square{1} & \\
 \mathcal{W} = bqqb + p_2e + bde + \text{Flip}[vd; bb]
 \end{array}
 \end{array}
 \tag{D.2}$$

The mass term in the superpotential p_2e after the deconfinement is what makes the case $n = 2$ specific. Indeed in the higher n case (5.56), it is no longer a mass term for the fields e and p_2 . We can then integrate out the fields p_2 and e to get:

$$\begin{array}{c}
 \begin{array}{ccc}
 \textcircled{2} \xrightarrow{b, \frac{2}{3}} \textcircled{4} \xrightarrow{q, \frac{1}{3}} \textcircled{8} \\
 \textcircled{2} \xrightarrow{-\frac{1}{3}, v} \square{1} \\
 \textcircled{2} \xrightarrow{-\frac{1}{3}, d} \square{1} \\
 \mathcal{W} = bqqb + \text{Flip}[vd; bb]
 \end{array}
 \equiv
 \begin{array}{ccc}
 \square{2} \xrightarrow{f, -\frac{1}{3}} \textcircled{2} \xrightarrow{b, \frac{2}{3}} \textcircled{4} \xrightarrow{q, \frac{1}{3}} \textcircled{8} \\
 \mathcal{W} = bqqb + \text{Flip}[ff; bb]
 \end{array}
 \end{array}
 \tag{D.3}$$

Then we dualize the $USp(4)$ gauge node using the IP duality [45]. Due to the term $bqqb$ in the superpotential, we don't produce a link between the $USp(2) \equiv SU(2)$ gauge node and

$USp(8)$ flavor node, since it becomes a mass term for such field. We obtain the following quiver after integrating out the massive field:

$$\begin{array}{c}
 \boxed{2} \xrightarrow{f, -\frac{1}{3}} \bigcirc{2} \xrightarrow{B, \frac{1}{3}} \bigcirc{2} \xrightarrow{Q, \frac{2}{3}} \boxed{8} \\
 \mathcal{W} = BQQB + \text{Flip}[QQ; ff]
 \end{array} \tag{D.4}$$

We now see that the $USp(2)$ on the left is connected to 4 fundamental chirals. This situation is referred as the quantum deformed moduli space (QDMS) [37, 38]. It triggers an Higgsing that leads to a complete breaking of the the two $USp(2)$ gauge nodes. The low energy d.o.f.'s consist of a traceful antisymmetric field A_1 of the $USp(8)$ flavor symmetry, a bifundamental field P between the $SU(2)$ and $USp(8)$ and a singlet η . The R-charges of all the fields are $\frac{2}{3}$. The WZ theory that we obtain is the following:

$$\begin{array}{c}
 \boxed{2} \xrightarrow{\times} \boxed{8} \xrightarrow{\text{loop } A_1, \frac{2}{3}} \boxed{8} \\
 \text{with } P, \frac{2}{3} \text{ between } \boxed{2} \text{ and } \boxed{8} \\
 \equiv \\
 \boxed{10} \xrightarrow{\text{loop } A, \frac{2}{3}} \boxed{10} \\
 \mathcal{W} = A_1 PP + A_1^3 + \text{tr}(A_1)A_1^2 + \eta PP \qquad \mathcal{W} = A^3 + \text{tr}(A)A^2
 \end{array} \tag{D.5}$$

The mapping between (D.4) and (D.5) is

$$\begin{array}{ccc}
 \text{Flipper}[QQ] & & A_1 \\
 f B Q & \longleftrightarrow & P \\
 B B & & \eta
 \end{array} \tag{D.6}$$

On the left of (D.5), we have written the most general superpotential compatible with the R-charges. We also combined all the fields on the l.h.s. so to form a traceful antisymmetric of $USp(10)$. The r.h.s. of (D.5) is precisely the desired result.

Appendix E

$\mathcal{N} = 1$ conformal manifolds of $\mathcal{N} = 2$ necklace quivers

We consider the \mathbb{Z}_k orbifold of $\mathcal{N} = 4$ $SU(N)$ SYM. The resulting theory is a $SU(N)^k$ quiver with a cubic superpotential consisting of $2k$ terms

$$\mathcal{W} = \sum_{i=1}^k \lambda_i \text{Tr}(\Phi_i Q_i \tilde{Q}_i - \Phi_i Q_{i+1} \tilde{Q}_{i+1}), \quad (\text{E.1})$$

where Φ_i is the adjoint of each gauge group and Q_i, \tilde{Q}_i are bifundamental hypermultiplets, with $\{Q_{k+1}, \tilde{Q}_{k+1}\} = \{Q_1, \tilde{Q}_1\}$. Each elementary chiral multiplet has the $\mathcal{N} = 1$ R-charge $R = \frac{2}{3}$ on the whole conformal manifold, which includes the free theory.

The $\mathcal{N} = 2$ conformal manifold is k -complex dimensional and is parameterized by the k gauge couplings. The precise $2k$ superpotential couplings are set by $\mathcal{N} = 2$ supersymmetry in terms of the gauge couplings τ_i , which are related by supersymmetry to the couplings λ_i in the $\mathcal{N} = 1$ superpotential.

We now want to determine the $\mathcal{N} = 1$ conformal manifold, which contains the $\mathcal{N} = 2$ conformal manifold as a submanifold. We use the method introduced in [272], of quotienting the space of marginal deformations (that is the chiral ring operators with $R_0 = 2$) by the broken global symmetries. If $k > 3$, there are $k + 1$ chiral ring operators with $R_0 = 2$ (if $k \leq 3$ there are additional operators which we discuss below)

$$\sum_{i=1}^k \text{Tr} \left(\Phi_i Q_i \tilde{Q}_i + \Phi_i Q_{i+1} \tilde{Q}_{i+1} \right) \quad \text{Tr}(\Phi_i^3), \quad i = 1, \dots, k. \quad (\text{E.2})$$

The global symmetry, in $\mathcal{N} = 1$ language, on the $\mathcal{N} = 2$ conformal submanifold is

$$U(1)_F \times U(1)_{\text{baryonic}}^k \times U(1)_{R_0}, \quad (\text{E.3})$$

where $U(1)_F$ acts with charges $+2, -1, -1$ on Φ_i, Q_i, \tilde{Q}_i , respectively, the i^{th} baryonic $U(1)$ acts with charge ± 1 on Q_i, \tilde{Q}_i leaving the remaining fields uncharged, and $U(1)_{R_0}$ assigns the canonical R-charge $R_0 = \frac{2}{3}$ to all the chirals. We conclude that the barionic $U(1)$'s are not broken by the marginal operators, while the $U(1)_F$ is broken.

Hence, there are $k + 1 - 1 = k$ additional $\mathcal{N} = 1$ directions on the conformal manifold. The full $\mathcal{N} = 1$ conformal manifold is $2k$ -dimensional for $k > 3$. One deformation is the β -deformation, which exists for any SCFT on D3-branes at toric Calabi–Yau singularities [273], while the other operators are linear combinations of the $\text{Tr}(\Phi_i^3)$ operators.

Special cases with $k \leq 3$

Let us briefly comment on the cases with $k \leq 3$, where additional direction in the $\mathcal{N} = 1$ conformal manifold arise.

- If $k = 1$ the theory is $\mathcal{N} = 4$ SYM and the $\mathcal{N} = 1$ conformal manifold is 3-dimensional, as we briefly reviewed in the previous subsection.
- If $k = 2$ there are 2 additional marginal operators in the chiral ring

$$\text{Tr}(\Phi_1 Q_1 \tilde{Q}_2) \sim \text{Tr}(\Phi_2 Q_2 \tilde{Q}_1), \quad \text{Tr}(\Phi_1 Q_2 \tilde{Q}_1) \sim \text{Tr}(\Phi_2 Q_1 \tilde{Q}_2), \quad (\text{E.4})$$

where the equivalences are due to the F-term relations. These operators break one of the 2 baryonic symmetries, hence they provide one additional direction in the conformal manifold, which is 5-dimensional.

- If $k = 3$ the operators

$$\text{Tr}(Q_1 Q_2 Q_3), \quad \text{Tr}(\tilde{Q}_1 \tilde{Q}_2 \tilde{Q}_3), \quad (\text{E.5})$$

are chiral ring operators with R-charge $R_0 = 2$. These operators break one of the 3 baryonic symmetries, hence they provide one additional direction in the conformal manifold, which is 7-dimensional.

Bibliography

- [1] Stephane Bajeot and Sergio Benvenuti. “S-confinements from deconfinements”. In: *JHEP* 11 (2022), p. 071. DOI: 10.1007/JHEP11(2022)071. arXiv: 2201.11049 [hep-th].
- [2] Stephane Bajeot and Sergio Benvenuti. “Sequential deconfinement and self-dualities in $4d\mathcal{N} = 1$ gauge theories”. In: *JHEP* 10 (2022), p. 007. DOI: 10.1007/JHEP10(2022)007. arXiv: 2206.11364 [hep-th].
- [3] Stephane Bajeot and Sergio Benvenuti. “4d N=1 dualities from 5d dualities”. In: (Dec. 2022). arXiv: 2212.11217 [hep-th].
- [4] Stephane Bajeot, Sergio Benvenuti, and Matteo Sacchi. “S-confining gauge theories and supersymmetry enhancements”. In: *JHEP* 08 (2023), p. 042. DOI: 10.1007/JHEP08(2023)042. arXiv: 2305.10274 [hep-th].
- [5] Meenakshi Narain et al. “The Future of US Particle Physics - The Snowmass 2021 Energy Frontier Report”. In: (Nov. 2022). arXiv: 2211.11084 [hep-ex].
- [6] David Poland and Leonardo Rastelli. “Snowmass Topical Summary: Formal QFT”. In: *Snowmass 2021*. Oct. 2022. arXiv: 2210.03128 [hep-th].
- [7] Daniel Harlow et al. “TF1 Snowmass Report: Quantum gravity, string theory, and black holes”. In: (Oct. 2022). arXiv: 2210.01737 [hep-th].
- [8] Prateek Agrawal et al. “Warped Compactifications in Particle Physics, Cosmology and Quantum Gravity”. In: *Snowmass 2021*. Mar. 2022. arXiv: 2203.07533 [hep-th].
- [9] Robert M. Wald. *Quantum Field Theory in Curved Space-Time and Black Hole Thermodynamics*. Chicago Lectures in Physics. Chicago, IL: University of Chicago Press, 1995. ISBN: 978-0-226-87027-4.
- [10] Ibrahima Bah et al. “Snowmass Whitepaper: Physical Mathematics 2021”. In: (Mar. 2022). arXiv: 2203.05078 [hep-th].
- [11] Ibrahima Bah et al. “A Panorama Of Physical Mathematics c. 2022”. In: (Nov. 2022). arXiv: 2211.04467 [hep-th].
- [12] Belal Ehsan Baaquie. *Quantum field theory for economics and finance*. Cambridge University Press, 2018.
- [13] Jean-Loup Gervais and B. Sakita. “Field Theory Interpretation of Supergauges in Dual Models”. In: *Nucl. Phys. B* 34 (1971). Ed. by K. Kikkawa, M. Virasoro, and S. R. Wadia, pp. 632–639. DOI: 10.1016/0550-3213(71)90351-8.

- [14] Yu. A. Golfand and E. P. Likhtman. “Extension of the Algebra of Poincare Group Generators and Violation of p Invariance”. In: *JETP Lett.* 13 (1971), pp. 323–326.
- [15] D. V. Volkov and V. P. Akulov. “Possible universal neutrino interaction”. In: *JETP Lett.* 16 (1972). Ed. by J. Wess and V. P. Akulov, pp. 438–440.
- [16] J. Wess and B. Zumino. “Supergauge Transformations in Four-Dimensions”. In: *Nucl. Phys. B* 70 (1974). Ed. by A. Salam and E. Sezgin, pp. 39–50. DOI: 10.1016/0550-3213(74)90355-1.
- [17] Abdus Salam and J. A. Strathdee. “Supersymmetry and Nonabelian Gauges”. In: *Phys. Lett. B* 51 (1974), pp. 353–355. DOI: 10.1016/0370-2693(74)90226-3.
- [18] Rudolf Haag, Jan T. Lopuszanski, and Martin Sohnius. “All Possible Generators of Supersymmetries of the s Matrix”. In: *Nucl. Phys. B* 88 (1975), p. 257. DOI: 10.1016/0550-3213(75)90279-5.
- [19] Amin Aboubrahim et al. “Future searches for SUSY at the LHC post Fermilab $(g-2)_\mu$ ”. In: *Snowmass 2021*. July 2021. arXiv: 2107.06021 [hep-ph].
- [20] Tulika Bose et al. “Report of the Topical Group on Physics Beyond the Standard Model at Energy Frontier for Snowmass 2021”. In: (Sept. 2022). arXiv: 2209.13128 [hep-ph].
- [21] Patrick J. Fox et al. “TF08 Snowmass Report: BSM Model Building”. In: (Oct. 2022). arXiv: 2210.03075 [hep-ph].
- [22] Michael B. Green, J. H. Schwarz, and Edward Witten. *SUPERSTRING THEORY. VOL. 1: INTRODUCTION*. Cambridge Monographs on Mathematical Physics. July 1988. ISBN: 978-0-521-35752-4.
- [23] Michael B. Green, J. H. Schwarz, and Edward Witten. *SUPERSTRING THEORY. VOL. 2: LOOP AMPLITUDES, ANOMALIES AND PHENOMENOLOGY*. July 1988. ISBN: 978-0-521-35753-1.
- [24] Eric M. Rains. “Transformations of elliptic hypergeometric integrals”. In: *arXiv Mathematics e-prints*, math/0309252 (Sept. 2003), math/0309252. DOI: 10.48550/arXiv.math/0309252. arXiv: math/0309252 [math.QA].
- [25] V Spiridonov. “Theta hypergeometric integrals”. In: *St. Petersburg Mathematical Journal* 15.6 (2004), pp. 929–967.
- [26] V. P. Spiridonov and G. S. Vartanov. “Elliptic Hypergeometry of Supersymmetric Dualities”. In: *Commun. Math. Phys.* 304 (2011), pp. 797–874. DOI: 10.1007/s00220-011-1218-9. arXiv: 0910.5944 [hep-th].
- [27] V. P. Spiridonov and G. S. Vartanov. “Elliptic hypergeometry of supersymmetric dualities II. Orthogonal groups, knots, and vortices”. In: *Commun. Math. Phys.* 325 (2014), pp. 421–486. DOI: 10.1007/s00220-013-1861-4. arXiv: 1107.5788 [hep-th].
- [28] Vasily Pestun et al. “Localization techniques in quantum field theories”. In: *J. Phys. A* 50.44 (2017), p. 440301. DOI: 10.1088/1751-8121/aa63c1. arXiv: 1608.02952 [hep-th].

- [29] Christian Romelsberger. “Counting chiral primaries in $N = 1$, $d=4$ superconformal field theories”. In: *Nucl. Phys. B* 747 (2006), pp. 329–353. DOI: 10.1016/j.nuclphysb.2006.03.037. arXiv: hep-th/0510060.
- [30] Justin Kinney et al. “An Index for 4 dimensional super conformal theories”. In: *Commun. Math. Phys.* 275 (2007), pp. 209–254. DOI: 10.1007/s00220-007-0258-7. arXiv: hep-th/0510251.
- [31] Arthur Jaffe and Edward Witten. “Quantum yang-mills theory”. In: *The millennium prize problems 1* (), p. 129.
- [32] N. Seiberg and Edward Witten. “Electric - magnetic duality, monopole condensation, and confinement in $N=2$ supersymmetric Yang-Mills theory”. In: *Nucl. Phys. B* 426 (1994). [Erratum: *Nucl.Phys.B* 430, 485–486 (1994)], pp. 19–52. DOI: 10.1016/0550-3213(94)90124-4. arXiv: hep-th/9407087.
- [33] N. Seiberg and Edward Witten. “Monopoles, duality and chiral symmetry breaking in $N=2$ supersymmetric QCD”. In: *Nucl. Phys. B* 431 (1994), pp. 484–550. DOI: 10.1016/0550-3213(94)90214-3. arXiv: hep-th/9408099.
- [34] Gerard 't Hooft. “Topology of the Gauge Condition and New Confinement Phases in Nonabelian Gauge Theories”. In: *Nucl. Phys. B* 190 (1981), pp. 455–478. DOI: 10.1016/0550-3213(81)90442-9.
- [35] Yoichiro Nambu. “Strings, Monopoles and Gauge Fields”. In: *Phys. Rev. D* 10 (1974). Ed. by T. Eguchi, p. 4262. DOI: 10.1103/PhysRevD.10.4262.
- [36] S. Mandelstam. “Vortices and Quark Confinement in Nonabelian Gauge Theories”. In: *Phys. Rept.* 23 (1976), pp. 245–249. DOI: 10.1016/0370-1573(76)90043-0.
- [37] Nathan Seiberg. “Exact results on the space of vacua of four-dimensional SUSY gauge theories”. In: *Phys. Rev. D* 49 (1994), pp. 6857–6863. DOI: 10.1103/PhysRevD.49.6857. arXiv: hep-th/9402044.
- [38] N. Seiberg. “Electric - magnetic duality in supersymmetric nonAbelian gauge theories”. In: *Nucl. Phys. B* 435 (1995), pp. 129–146. DOI: 10.1016/0550-3213(94)00023-8. arXiv: hep-th/9411149.
- [39] Nathan Seiberg. “The Power of holomorphy: Exact results in 4-D SUSY field theories”. In: *Particles, Strings, and Cosmology (PASCOS 94)*. May 1994, pp. 0357–369. arXiv: hep-th/9408013.
- [40] Kenneth A. Intriligator and N. Seiberg. “Lectures on supersymmetric gauge theories and electric-magnetic duality”. In: *Nucl. Phys. B Proc. Suppl.* 45BC (1996). Ed. by A. Zichichi, pp. 1–28. DOI: 10.1016/0920-5632(95)00626-5. arXiv: hep-th/9509066.
- [41] J. Terning. *Modern supersymmetry: Dynamics and duality*. 2006. DOI: 10.1093/acprof:oso/9780198567639.001.0001.
- [42] Matteo Bertolini. *Lectures on Supersymmetry*. <https://people.sissa.it/~bertmat/susycourse.pdf>. 2023.

- [43] Matthew J. Strassler. “Erice Lectures on Confinement and Duality”. In: *ICTP Lect. Notes Ser.* 7 (2002). Ed. by A. Zichichi, pp. 105–162. DOI: 10.1142/9789812796653_0004.
- [44] Csaba Csaki, Martin Schmaltz, and Witold Skiba. “A Systematic approach to confinement in N=1 supersymmetric gauge theories”. In: *Phys. Rev. Lett.* 78 (1997), pp. 799–802. DOI: 10.1103/PhysRevLett.78.799. arXiv: hep-th/9610139.
- [45] Kenneth A. Intriligator and P. Pouliot. “Exact superpotentials, quantum vacua and duality in supersymmetric SP(N(c)) gauge theories”. In: *Phys. Lett. B* 353 (1995), pp. 471–476. DOI: 10.1016/0370-2693(95)00618-U. arXiv: hep-th/9505006.
- [46] Csaba Csaki, Martin Schmaltz, and Witold Skiba. “Confinement in N=1 SUSY gauge theories and model building tools”. In: *Phys. Rev. D* 55 (1997), pp. 7840–7858. DOI: 10.1103/PhysRevD.55.7840. arXiv: hep-th/9612207.
- [47] Chiung Hwang, Sara Pasquetti, and Matteo Sacchi. “4d mirror-like dualities”. In: *JHEP* 09 (2020), p. 047. DOI: 10.1007/JHEP09(2020)047. arXiv: 2002.12897 [hep-th].
- [48] Lea E. Bottini et al. “4d S-duality wall and SL(2, Z) relations”. In: *JHEP* 03 (2022), p. 035. DOI: 10.1007/JHEP03(2022)035. arXiv: 2110.08001 [hep-th].
- [49] Chiung Hwang, Sara Pasquetti, and Matteo Sacchi. “Rethinking mirror symmetry as a local duality on fields”. In: *Phys. Rev. D* 106.10 (2022), p. 105014. DOI: 10.1103/PhysRevD.106.105014. arXiv: 2110.11362 [hep-th].
- [50] Riccardo Comi et al. “The SL(2, Z) dualization algorithm at work”. In: (Dec. 2022). arXiv: 2212.10571 [hep-th].
- [51] N. Seiberg. “The Power of duality: Exact results in 4-D SUSY field theory”. In: *Prog. Theor. Phys. Suppl.* 123 (1996). Ed. by Y. M. Cho, J. B. Hong, and C. N. Yang, pp. 337–347. DOI: 10.1142/S0217751X01005705. arXiv: hep-th/9506077.
- [52] Kenneth A. Intriligator and N. Seiberg. “Duality, monopoles, dyons, confinement and oblique confinement in supersymmetric SO(N(c)) gauge theories”. In: *Nucl. Phys. B* 444 (1995), pp. 125–160. DOI: 10.1016/0550-3213(95)00159-P. arXiv: hep-th/9503179.
- [53] Kenneth A. Intriligator. “New RG fixed points and duality in supersymmetric SP(N(c)) and SO(N(c)) gauge theories”. In: *Nucl. Phys. B* 448 (1995), pp. 187–198. DOI: 10.1016/0550-3213(95)00296-5. arXiv: hep-th/9505051.
- [54] D. Kutasov. “A Comment on duality in N=1 supersymmetric nonAbelian gauge theories”. In: *Phys. Lett. B* 351 (1995), pp. 230–234. DOI: 10.1016/0370-2693(95)00392-X. arXiv: hep-th/9503086.
- [55] D. Kutasov and A. Schwimmer. “On duality in supersymmetric Yang-Mills theory”. In: *Phys. Lett. B* 354 (1995), pp. 315–321. DOI: 10.1016/0370-2693(95)00676-C. arXiv: hep-th/9505004.
- [56] Kenneth A. Intriligator, R. G. Leigh, and M. J. Strassler. “New examples of duality in chiral and nonchiral supersymmetric gauge theories”. In: *Nucl. Phys. B* 456 (1995), pp. 567–621. DOI: 10.1016/0550-3213(95)00473-1. arXiv: hep-th/9506148.

- [57] R. G. Leigh and M. J. Strassler. “Duality of $\text{Sp}(2N(c))$ and $\text{SO}(N(c))$ supersymmetric gauge theories with adjoint matter”. In: *Phys. Lett. B* 356 (1995), pp. 492–499. DOI: 10.1016/0370-2693(95)00871-H. arXiv: hep-th/9505088.
- [58] P. Pouliot. “Duality in SUSY $\text{SU}(N)$ with an antisymmetric tensor”. In: *Phys. Lett. B* 367 (1996), pp. 151–156. DOI: 10.1016/0370-2693(95)01427-6. arXiv: hep-th/9510148.
- [59] P. Pouliot and M. J. Strassler. “A Chiral $\text{SU}(n)$ gauge theory and its nonchiral $\text{spin}(8)$ dual”. In: *Phys. Lett. B* 370 (1996), pp. 76–82. DOI: 10.1016/0370-2693(95)01554-X. arXiv: hep-th/9510228.
- [60] M. Berkooz. “The Dual of supersymmetric $\text{SU}(2k)$ with an antisymmetric tensor and composite dualities”. In: *Nucl. Phys. B* 452 (1995), pp. 513–525. DOI: 10.1016/0550-3213(95)00400-M. arXiv: hep-th/9505067.
- [61] John H. Brodie and Matthew J. Strassler. “Patterns of duality in $N=1$ SUSY gauge theories, or: Seating preferences of theater going nonAbelian dualities”. In: *Nucl. Phys. B* 524 (1998), pp. 224–250. DOI: 10.1016/S0550-3213(98)00188-6. arXiv: hep-th/9611197.
- [62] Csaba Csaki, Witold Skiba, and Martin Schmaltz. “Exact results and duality for $\text{SP}(2N)$ SUSY gauge theories with an antisymmetric tensor”. In: *Nucl. Phys. B* 487 (1997), pp. 128–140. DOI: 10.1016/S0550-3213(96)00709-2. arXiv: hep-th/9607210.
- [63] Markus A. Luty, Martin Schmaltz, and John Terning. “A Sequence of duals for $\text{Sp}(2N)$ supersymmetric gauge theories with adjoint matter”. In: *Phys. Rev. D* 54 (1996), pp. 7815–7824. DOI: 10.1103/PhysRevD.54.7815. arXiv: hep-th/9603034.
- [64] Jacques Distler and Andreas Karch. “ $N=1$ dualities for exceptional gauge groups and quantum global symmetries”. In: *Fortsch. Phys.* 45 (1997), pp. 517–533. DOI: 10.1002/prop.2190450603. arXiv: hep-th/9611088.
- [65] Csaba Csaki et al. “Selfdual $N=1$ SUSY gauge theories”. In: *Phys. Rev. D* 56 (1997), pp. 1228–1238. DOI: 10.1103/PhysRevD.56.1228. arXiv: hep-th/9701191.
- [66] John Terning. “Duals for $\text{SU}(N)$ SUSY gauge theories with an antisymmetric tensor: Five easy flavors”. In: *Phys. Lett. B* 422 (1998), pp. 149–157. DOI: 10.1016/S0370-2693(98)00074-4. arXiv: hep-th/9712167.
- [67] Matthew J. Strassler. “Duality, phases, spinors and monopoles in $\text{SO}(N)$ and $\text{spin}(N)$ gauge theories”. In: *JHEP* 09 (1998), p. 017. DOI: 10.1088/1126-6708/1998/09/017. arXiv: hep-th/9709081.
- [68] Ofer Aharony. “IR duality in $d = 3$ $N=2$ supersymmetric $\text{USp}(2N(c))$ and $\text{U}(N(c))$ gauge theories”. In: *Phys. Lett. B* 404 (1997), pp. 71–76. DOI: 10.1016/S0370-2693(97)00530-3. arXiv: hep-th/9703215.
- [69] Andreas Karch. “Seiberg duality in three-dimensions”. In: *Phys. Lett. B* 405 (1997), pp. 79–84. DOI: 10.1016/S0370-2693(97)00598-4. arXiv: hep-th/9703172.

- [70] Amit Giveon and David Kutasov. “Seiberg Duality in Chern-Simons Theory”. In: *Nucl. Phys. B* 812 (2009), pp. 1–11. DOI: 10.1016/j.nuclphysb.2008.09.045. arXiv: 0808.0360 [hep-th].
- [71] Vasilis Niarchos. “Seiberg Duality in Chern-Simons Theories with Fundamental and Adjoint Matter”. In: *JHEP* 11 (2008), p. 001. DOI: 10.1088/1126-6708/2008/11/001. arXiv: 0808.2771 [hep-th].
- [72] Anton Kapustin. “Seiberg-like duality in three dimensions for orthogonal gauge groups”. In: (Apr. 2011). arXiv: 1104.0466 [hep-th].
- [73] Anton Kapustin, Hyungchul Kim, and Jaemo Park. “Dualities for 3d Theories with Tensor Matter”. In: *JHEP* 12 (2011), p. 087. DOI: 10.1007/JHEP12(2011)087. arXiv: 1110.2547 [hep-th].
- [74] Ofer Aharony and Itamar Shamir. “On $O(N_c)d = 3$ $N = 2$ supersymmetric QCD Theories”. In: *JHEP* 12 (2011), p. 043. DOI: 10.1007/JHEP12(2011)043. arXiv: 1109.5081 [hep-th].
- [75] Hyungchul Kim and Jaemo Park. “Aharony Dualities for 3d Theories with Adjoint Matter”. In: *JHEP* 06 (2013), p. 106. DOI: 10.1007/JHEP06(2013)106. arXiv: 1302.3645 [hep-th].
- [76] Jaemo Park and Kyung-Jae Park. “Seiberg-like Dualities for 3d $N=2$ Theories with $SU(N)$ gauge group”. In: *JHEP* 10 (2013), p. 198. DOI: 10.1007/JHEP10(2013)198. arXiv: 1305.6280 [hep-th].
- [77] Kentaro Hori and David Tong. “Aspects of Non-Abelian Gauge Dynamics in Two-Dimensional $N=(2,2)$ Theories”. In: *JHEP* 05 (2007), p. 079. DOI: 10.1088/1126-6708/2007/05/079. arXiv: hep-th/0609032.
- [78] Kentaro Hori. “Duality In Two-Dimensional (2,2) Supersymmetric Non-Abelian Gauge Theories”. In: *JHEP* 10 (2013), p. 121. DOI: 10.1007/JHEP10(2013)121. arXiv: 1104.2853 [hep-th].
- [79] Francesco Benini, Daniel S. Park, and Peng Zhao. “Cluster Algebras from Dualities of 2d $\mathcal{N} = (2, 2)$ Quiver Gauge Theories”. In: *Commun. Math. Phys.* 340 (2015), pp. 47–104. DOI: 10.1007/s00220-015-2452-3. arXiv: 1406.2699 [hep-th].
- [80] Sergio Benvenuti and Simone Giacomelli. “Abelianization and sequential confinement in 2+1 dimensions”. In: *JHEP* 10 (2017), p. 173. DOI: 10.1007/JHEP10(2017)173. arXiv: 1706.04949 [hep-th].
- [81] Simone Giacomelli and Noppadol Mekareeya. “Mirror theories of 3d $\mathcal{N} = 2$ SQCD”. In: *JHEP* 03 (2018), p. 126. DOI: 10.1007/JHEP03(2018)126. arXiv: 1711.11525 [hep-th].
- [82] Sara Pasquetti and Matteo Sacchi. “From 3d dualities to 2d free field correlators and back”. In: *JHEP* 11 (2019), p. 081. DOI: 10.1007/JHEP11(2019)081. arXiv: 1903.10817 [hep-th].

- [83] Sara Pasquetti and Matteo Sacchi. “3d dualities from 2d free field correlators: recombination and rank stabilization”. In: *JHEP* 01 (2020), p. 061. DOI: 10.1007/JHEP01(2020)061. arXiv: 1905.05807 [hep-th].
- [84] Matteo Sacchi. “New 2d $\mathcal{N} = (0, 2)$ dualities from four dimensions”. In: *JHEP* 12 (2020), p. 009. DOI: 10.1007/JHEP12(2020)009. arXiv: 2004.13672 [hep-th].
- [85] Sergio Benvenuti, Ivan Garozzo, and Gabriele Lo Monaco. “Sequential deconfinement in 3d $\mathcal{N} = 2$ gauge theories”. In: *JHEP* 07 (2021), p. 191. DOI: 10.1007/JHEP07(2021)191. arXiv: 2012.09773 [hep-th].
- [86] Lea E. Bottini et al. “Dualities from dualities: the sequential deconfinement technique”. In: *JHEP* 05 (2022), p. 069. DOI: 10.1007/JHEP05(2022)069. arXiv: 2201.11090 [hep-th].
- [87] Sergio Benvenuti and Gabriele Lo Monaco. “A toolkit for ortho-symplectic dualities”. In: (Dec. 2021). arXiv: 2112.12154 [hep-th].
- [88] Inaki Garcia-Etxebarria, Ben Heidenreich, and Timm Wrase. “New $N=1$ dualities from orientifold transitions. Part I. Field Theory”. In: *JHEP* 10 (2013), p. 007. DOI: 10.1007/JHEP10(2013)007. arXiv: 1210.7799 [hep-th].
- [89] Iñaki García-Etxebarria, Ben Heidenreich, and Timm Wrase. “New $N=1$ dualities from orientifold transitions - Part II: String Theory”. In: *JHEP* 10 (2013), p. 006. DOI: 10.1007/JHEP10(2013)006. arXiv: 1307.1701 [hep-th].
- [90] Iñaki García Etxebarria et al. “Deconfining $\mathcal{N} = 2$ SCFTs or the art of brane bending”. In: *JHEP* 03 (2022), p. 140. DOI: 10.1007/JHEP03(2022)140. arXiv: 2111.08022 [hep-th].
- [91] Nezhla Aghaei, Antonio Amariti, and Yuta Sekiguchi. “Notes on Integral Identities for 3d Supersymmetric Dualities”. In: *JHEP* 04 (2018), p. 022. DOI: 10.1007/JHEP04(2018)022. arXiv: 1709.08653 [hep-th].
- [92] Sergio Benvenuti. “A tale of exceptional 3d dualities”. In: *JHEP* 03 (2019), p. 125. DOI: 10.1007/JHEP03(2019)125. arXiv: 1809.03925 [hep-th].
- [93] Antonio Amariti and Luca Cassia. “ $USp(2N_c)$ SQCD₃ with antisymmetric: dualities and symmetry enhancements”. In: *JHEP* 02 (2019), p. 013. DOI: 10.1007/JHEP02(2019)013. arXiv: 1809.03796 [hep-th].
- [94] Francesco Benini, Sergio Benvenuti, and Sara Pasquetti. “SUSY monopole potentials in 2+1 dimensions”. In: *JHEP* 08 (2017), p. 086. DOI: 10.1007/JHEP08(2017)086. arXiv: 1703.08460 [hep-th].
- [95] Sergio Benvenuti and Simone Giacomelli. “Supersymmetric gauge theories with decoupled operators and chiral ring stability”. In: *Phys. Rev. Lett.* 119.25 (2017), p. 251601. DOI: 10.1103/PhysRevLett.119.251601. arXiv: 1706.02225 [hep-th].
- [96] Sergio Benvenuti and Simone Giacomelli. “Lagrangians for generalized Argyres-Douglas theories”. In: *JHEP* 10 (2017), p. 106. DOI: 10.1007/JHEP10(2017)106. arXiv: 1707.05113 [hep-th].

- [97] Keita Nii. “On s-confinement in 3d $\mathcal{N} = 2$ gauge theories with anti-symmetric tensors”. In: (June 2019). arXiv: 1906.03908 [hep-th].
- [98] Antonio Amariti and Simone Rota. “3d $\mathcal{N} = 2$ SO/USp adjoint SQCD: s-confinement and exact identities”. In: (Feb. 2022). arXiv: 2202.06885 [hep-th].
- [99] Th. Kaluza. “Zum Unitätsproblem der Physik”. In: *Sitzungsber. Preuss. Akad. Wiss. Berlin (Math. Phys.)* 1921 (1921), pp. 966–972. DOI: 10.1142/S0218271818700017. arXiv: 1803.08616 [physics.hist-ph].
- [100] Oskar Klein. “Quantum Theory and Five-Dimensional Theory of Relativity. (In German and English)”. In: *Z. Phys.* 37 (1926). Ed. by J. C. Taylor, pp. 895–906. DOI: 10.1007/BF01397481.
- [101] Mirjam Cvetič et al. “Snowmass White Paper: String Theory and Particle Physics”. In: (Apr. 2022). arXiv: 2204.01742 [hep-th].
- [102] Vasilis Niarchos. “Seiberg dualities and the 3d/4d connection”. In: *JHEP* 07 (2012), p. 075. DOI: 10.1007/JHEP07(2012)075. arXiv: 1205.2086 [hep-th].
- [103] Ofer Aharony et al. “3d dualities from 4d dualities”. In: *JHEP* 07 (2013), p. 149. DOI: 10.1007/JHEP07(2013)149. arXiv: 1305.3924 [hep-th].
- [104] Ofer Aharony et al. “3d dualities from 4d dualities for orthogonal groups”. In: *JHEP* 08 (2013), p. 099. DOI: 10.1007/JHEP08(2013)099. arXiv: 1307.0511 [hep-th].
- [105] F. A. H. Dolan, V. P. Spiridonov, and G. S. Vartanov. “From 4d superconformal indices to 3d partition functions”. In: *Phys. Lett. B* 704 (2011), pp. 234–241. DOI: 10.1016/j.physletb.2011.09.007. arXiv: 1104.1787 [hep-th].
- [106] Keita Nii. “3d duality with adjoint matter from 4d duality”. In: *JHEP* 02 (2015), p. 024. DOI: 10.1007/JHEP02(2015)024. arXiv: 1409.3230 [hep-th].
- [107] Mina Aganagic et al. “Mirror symmetry in (2+1)-dimensions and (1+1)-dimensions”. In: *JHEP* 07 (2001), p. 022. DOI: 10.1088/1126-6708/2001/07/022. arXiv: hep-th/0105075.
- [108] Ofer Aharony, Shlomo S. Razamat, and Brian Willett. “From 3d duality to 2d duality”. In: *JHEP* 11 (2017), p. 090. DOI: 10.1007/JHEP11(2017)090. arXiv: 1710.00926 [hep-th].
- [109] Abhijit Gadde, Shlomo S. Razamat, and Brian Willett. “On the reduction of 4d $\mathcal{N} = 1$ theories on \mathbb{S}^2 ”. In: *JHEP* 11 (2015), p. 163. DOI: 10.1007/JHEP11(2015)163. arXiv: 1506.08795 [hep-th].
- [110] Daniel Jafferis and Xi Yin. “A Duality Appetizer”. In: (Mar. 2011). arXiv: 1103.5700 [hep-th].
- [111] Sara Pasquetti et al. “Rank Q E-string on a torus with flux”. In: *SciPost Phys.* 8.1 (2020), p. 014. DOI: 10.21468/SciPostPhys.8.1.014. arXiv: 1908.03278 [hep-th].

- [112] Nathan Seiberg. “Five-dimensional SUSY field theories, nontrivial fixed points and string dynamics”. In: *Phys. Lett. B* 388 (1996), pp. 753–760. DOI: 10.1016/S0370-2693(96)01215-4. arXiv: hep-th/9608111.
- [113] Nathan Seiberg. “Nontrivial fixed points of the renormalization group in six-dimensions”. In: *Phys. Lett. B* 390 (1997), pp. 169–171. DOI: 10.1016/S0370-2693(96)01424-4. arXiv: hep-th/9609161.
- [114] David R. Morrison and Nathan Seiberg. “Extremal transitions and five-dimensional supersymmetric field theories”. In: *Nucl. Phys. B* 483 (1997), pp. 229–247. DOI: 10.1016/S0550-3213(96)00592-5. arXiv: hep-th/9609070.
- [115] Pietro Benetti Genolini et al. “Evidence for a Non-Supersymmetric 5d CFT from Deformations of 5d $SU(2)$ SYM”. In: *JHEP* 05 (2020), p. 058. DOI: 10.1007/JHEP05(2020)058. arXiv: 2001.00023 [hep-th].
- [116] Adrien Florio et al. “Searching for continuous phase transitions in 5D $SU(2)$ lattice gauge theory”. In: *JHEP* 12 (2021), p. 076. DOI: 10.1007/JHEP12(2021)076. arXiv: 2103.15242 [hep-lat].
- [117] Fabiana De Cesare, Lorenzo Di Pietro, and Marco Serone. “Five-dimensional CFTs from the ϵ -expansion”. In: *Phys. Rev. D* 104.10 (2021), p. 105015. DOI: 10.1103/PhysRevD.104.105015. arXiv: 2107.00342 [hep-th].
- [118] Matteo Bertolini and Francesco Mignosa. “Supersymmetry breaking deformations and phase transitions in five dimensions”. In: *JHEP* 10 (2021), p. 244. DOI: 10.1007/JHEP10(2021)244. arXiv: 2109.02662 [hep-th].
- [119] Matteo Bertolini, Francesco Mignosa, and Jesse van Muiden. “On non-supersymmetric fixed points in five dimensions”. In: *JHEP* 10 (2022), p. 064. DOI: 10.1007/JHEP10(2022)064. arXiv: 2207.11162 [hep-th].
- [120] Fabiana De Cesare, Lorenzo Di Pietro, and Marco Serone. “Free energy on the sphere for non-abelian gauge theories”. In: *JHEP* 04 (2023), p. 099. DOI: 10.1007/JHEP04(2023)099. arXiv: 2212.11848 [hep-th].
- [121] Mohammad Akhond, Masazumi Honda, and Francesco Mignosa. “5d SCFTs and their non-supersymmetric cousins”. In: (July 2023). arXiv: 2307.13724 [hep-th].
- [122] W. Nahm. “Supersymmetries and their Representations”. In: *Nucl. Phys. B* 135 (1978), p. 149. DOI: 10.1016/0550-3213(78)90218-3.
- [123] Edward Witten. “Some comments on string dynamics”. In: *STRINGS 95: Future Perspectives in String Theory*. July 1995, pp. 501–523. arXiv: hep-th/9507121.
- [124] Andrew Strominger. “Open p-branes”. In: *Phys. Lett. B* 383 (1996), pp. 44–47. DOI: 10.1016/0370-2693(96)00712-5. arXiv: hep-th/9512059.
- [125] Mans Henningson. “Self-dual strings in six dimensions: Anomalies, the ADE-classification, and the world-sheet WZW-model”. In: *Commun. Math. Phys.* 257 (2005), pp. 291–302. DOI: 10.1007/s00220-005-1324-7. arXiv: hep-th/0405056.

- [126] Clay Cordova, Thomas T. Dumitrescu, and Xi Yin. “Higher derivative terms, toroidal compactification, and Weyl anomalies in six-dimensional $(2, 0)$ theories”. In: *JHEP* 10 (2019), p. 128. DOI: 10.1007/JHEP10(2019)128. arXiv: 1505.03850 [hep-th].
- [127] Jonathan J. Heckman, David R. Morrison, and Cumrun Vafa. “On the Classification of 6D SCFTs and Generalized ADE Orbifolds”. In: *JHEP* 05 (2014). [Erratum: *JHEP* 06, 017 (2015)], p. 028. DOI: 10.1007/JHEP05(2014)028. arXiv: 1312.5746 [hep-th].
- [128] Jonathan J. Heckman et al. “Atomic Classification of 6D SCFTs”. In: *Fortsch. Phys.* 63 (2015), pp. 468–530. DOI: 10.1002/prop.201500024. arXiv: 1502.05405 [hep-th].
- [129] Lakshya Bhardwaj. “Classification of 6d $\mathcal{N} = (1, 0)$ gauge theories”. In: *JHEP* 11 (2015), p. 002. DOI: 10.1007/JHEP11(2015)002. arXiv: 1502.06594 [hep-th].
- [130] Jonathan J. Heckman and Tom Rudelius. “Top Down Approach to 6D SCFTs”. In: *J. Phys. A* 52.9 (2019), p. 093001. DOI: 10.1088/1751-8121/aafc81. arXiv: 1805.06467 [hep-th].
- [131] Patrick Jefferson et al. “Towards classification of 5d SCFTs: Single gauge node”. In: *SciPost Phys.* 14.5 (2023), p. 122. DOI: 10.21468/SciPostPhys.14.5.122. arXiv: 1705.05836 [hep-th].
- [132] Patrick Jefferson et al. “On Geometric Classification of 5d SCFTs”. In: *JHEP* 04 (2018), p. 103. DOI: 10.1007/JHEP04(2018)103. arXiv: 1801.04036 [hep-th].
- [133] Lakshya Bhardwaj and Patrick Jefferson. “Classifying 5d SCFTs via 6d SCFTs: Rank one”. In: *JHEP* 07 (2019). [Addendum: *JHEP* 01, 153 (2020)], p. 178. DOI: 10.1007/JHEP07(2019)178. arXiv: 1809.01650 [hep-th].
- [134] Lakshya Bhardwaj and Patrick Jefferson. “Classifying 5d SCFTs via 6d SCFTs: Arbitrary rank”. In: *JHEP* 10 (2019), p. 282. DOI: 10.1007/JHEP10(2019)282. arXiv: 1811.10616 [hep-th].
- [135] Lakshya Bhardwaj et al. “Twisted Circle Compactifications of 6d SCFTs”. In: *JHEP* 12 (2020), p. 151. DOI: 10.1007/JHEP12(2020)151. arXiv: 1909.11666 [hep-th].
- [136] Fabio Apruzzi et al. “5d Superconformal Field Theories and Graphs”. In: *Phys. Lett. B* 800 (2020), p. 135077. DOI: 10.1016/j.physletb.2019.135077. arXiv: 1906.11820 [hep-th].
- [137] Fabio Apruzzi et al. “Fibers add Flavor, Part I: Classification of 5d SCFTs, Flavor Symmetries and BPS States”. In: *JHEP* 11 (2019), p. 068. DOI: 10.1007/JHEP11(2019)068. arXiv: 1907.05404 [hep-th].
- [138] Fabio Apruzzi et al. “Fibers add Flavor, Part II: 5d SCFTs, Gauge Theories, and Dualities”. In: *JHEP* 03 (2020), p. 052. DOI: 10.1007/JHEP03(2020)052. arXiv: 1909.09128 [hep-th].
- [139] Cumrun Vafa. “Geometric origin of Montonen-Olive duality”. In: *Adv. Theor. Math. Phys.* 1 (1998), pp. 158–166. DOI: 10.4310/ATMP.1997.v1.n1.a6. arXiv: hep-th/9707131.

- [140] P. Goddard, J. Nuyts, and David I. Olive. “Gauge Theories and Magnetic Charge”. In: *Nucl. Phys. B* 125 (1977), pp. 1–28. DOI: 10.1016/0550-3213(77)90221-8.
- [141] Hugh Osborn. “Topological Charges for N=4 Supersymmetric Gauge Theories and Monopoles of Spin 1”. In: *Phys. Lett. B* 83 (1979), pp. 321–326. DOI: 10.1016/0370-2693(79)91118-3.
- [142] Davide Gaiotto. “N=2 dualities”. In: *JHEP* 08 (2012), p. 034. DOI: 10.1007/JHEP08(2012)034. arXiv: 0904.2715 [hep-th].
- [143] Davide Gaiotto, Gregory W. Moore, and Andrew Neitzke. “Wall-crossing, Hitchin systems, and the WKB approximation”. In: *Adv. Math.* 234 (2013), pp. 239–403. DOI: 10.1016/j.aim.2012.09.027. arXiv: 0907.3987 [hep-th].
- [144] Edward Witten. “Solutions of four-dimensional field theories via M theory”. In: *Nucl. Phys. B* 500 (1997), pp. 3–42. DOI: 10.1016/S0550-3213(97)00416-1. arXiv: hep-th/9703166.
- [145] Davide Gaiotto and Juan Maldacena. “The Gravity duals of N=2 superconformal field theories”. In: *JHEP* 10 (2012), p. 189. DOI: 10.1007/JHEP10(2012)189. arXiv: 0904.4466 [hep-th].
- [146] Oscar Chacaltana and Jacques Distler. “Tinkertoys for Gaiotto Duality”. In: *JHEP* 11 (2010), p. 099. DOI: 10.1007/JHEP11(2010)099. arXiv: 1008.5203 [hep-th].
- [147] Oscar Chacaltana and Jacques Distler. “Tinkertoys for the D_N series”. In: *JHEP* 02 (2013), p. 110. DOI: 10.1007/JHEP02(2013)110. arXiv: 1106.5410 [hep-th].
- [148] Oscar Chacaltana, Jacques Distler, and Yuji Tachikawa. “Nilpotent orbits and codimension-two defects of 6d N=(2,0) theories”. In: *Int. J. Mod. Phys. A* 28 (2013), p. 1340006. DOI: 10.1142/S0217751X1340006X. arXiv: 1203.2930 [hep-th].
- [149] Oscar Chacaltana, Jacques Distler, and Yuji Tachikawa. “Gaiotto duality for the twisted A_{2N-1} series”. In: *JHEP* 05 (2015), p. 075. DOI: 10.1007/JHEP05(2015)075. arXiv: 1212.3952 [hep-th].
- [150] Oscar Chacaltana, Jacques Distler, and Anderson Trimm. “Tinkertoys for the Twisted D-Series”. In: *JHEP* 04 (2015), p. 173. DOI: 10.1007/JHEP04(2015)173. arXiv: 1309.2299 [hep-th].
- [151] Oscar Chacaltana, Jacques Distler, and Anderson Trimm. “Tinkertoys for the E_6 theory”. In: *JHEP* 09 (2015), p. 007. DOI: 10.1007/JHEP09(2015)007. arXiv: 1403.4604 [hep-th].
- [152] Oscar Chacaltana, Jacques Distler, and Anderson Trimm. “A Family of 4D $\mathcal{N} = 2$ Interacting SCFTs from the Twisted A_{2N} Series”. In: (Dec. 2014). arXiv: 1412.8129 [hep-th].
- [153] Oscar Chacaltana, Jacques Distler, and Anderson Trimm. “Tinkertoys for the Twisted E_6 Theory”. In: (Jan. 2015). arXiv: 1501.00357 [hep-th].
- [154] Oscar Chacaltana, Jacques Distler, and Anderson Trimm. “Tinkertoys for the Z3-twisted D4 Theory”. In: (Jan. 2016). arXiv: 1601.02077 [hep-th].

- [155] Oscar Chacaltana et al. “Tinkertoys for the E_7 theory”. In: *JHEP* 05 (2018), p. 031. DOI: 10.1007/JHEP05(2018)031. arXiv: 1704.07890 [hep-th].
- [156] Oscar Chacaltana et al. “Tinkertoys for the E_8 Theory”. In: (Feb. 2018). arXiv: 1802.09626 [hep-th].
- [157] Giulio Bonelli, Kazunobu Maruyoshi, and Alessandro Tanzini. “Wild Quiver Gauge Theories”. In: *JHEP* 02 (2012), p. 031. DOI: 10.1007/JHEP02(2012)031. arXiv: 1112.1691 [hep-th].
- [158] Dan Xie. “General Argyres-Douglas Theory”. In: *JHEP* 01 (2013), p. 100. DOI: 10.1007/JHEP01(2013)100. arXiv: 1204.2270 [hep-th].
- [159] Yifan Wang and Dan Xie. “Classification of Argyres-Douglas theories from M5 branes”. In: *Phys. Rev. D* 94.6 (2016), p. 065012. DOI: 10.1103/PhysRevD.94.065012. arXiv: 1509.00847 [hep-th].
- [160] Yifan Wang and Dan Xie. “Codimension-two defects and Argyres-Douglas theories from outer-automorphism twist in 6d $(2, 0)$ theories”. In: *Phys. Rev. D* 100.2 (2019), p. 025001. DOI: 10.1103/PhysRevD.100.025001. arXiv: 1805.08839 [hep-th].
- [161] Davide Gaiotto. “Asymptotically free $\mathcal{N} = 2$ theories and irregular conformal blocks”. In: *J. Phys. Conf. Ser.* 462.1 (2013). Ed. by Sumit R. Das and Alfred D. Shapere, p. 012014. DOI: 10.1088/1742-6596/462/1/012014. arXiv: 0908.0307 [hep-th].
- [162] Sergio Cecotti, Michele Del Zotto, and Simone Giacomelli. “More on the $N=2$ superconformal systems of type $D_p(G)$ ”. In: *JHEP* 04 (2013), p. 153. DOI: 10.1007/JHEP04(2013)153. arXiv: 1303.3149 [hep-th].
- [163] Yuji Tachikawa. “Six-dimensional $D(N)$ theory and four-dimensional SO - USp quivers”. In: *JHEP* 07 (2009), p. 067. DOI: 10.1088/1126-6708/2009/07/067. arXiv: 0905.4074 [hep-th].
- [164] Yuji Tachikawa. “ $N=2$ S-duality via Outer-automorphism Twists”. In: *J. Phys. A* 44 (2011), p. 182001. DOI: 10.1088/1751-8113/44/18/182001. arXiv: 1009.0339 [hep-th].
- [165] Mohammad Akhond et al. “The hitchhiker’s guide to 4d $\mathcal{N} = 2$ superconformal field theories”. In: *SciPost Phys. Lect. Notes* 64 (2022), p. 1. DOI: 10.21468/SciPostPhysLectNotes.64. arXiv: 2112.14764 [hep-th].
- [166] Francesco Benini, Yuji Tachikawa, and Brian Wecht. “Sicilian gauge theories and $N=1$ dualities”. In: *JHEP* 01 (2010), p. 088. DOI: 10.1007/JHEP01(2010)088. arXiv: 0909.1327 [hep-th].
- [167] Ibrahima Bah and Brian Wecht. “New $N=1$ Superconformal Field Theories In Four Dimensions”. In: *JHEP* 07 (2013), p. 107. DOI: 10.1007/JHEP07(2013)107. arXiv: 1111.3402 [hep-th].
- [168] Ibrahima Bah et al. “AdS/CFT Dual Pairs from M5-Branes on Riemann Surfaces”. In: *Phys. Rev. D* 85 (2012), p. 121901. DOI: 10.1103/PhysRevD.85.121901. arXiv: 1112.5487 [hep-th].

- [169] Ibrahima Bah et al. “Four-Dimensional SCFTs from M5-Branes”. In: *JHEP* 06 (2012), p. 005. DOI: 10.1007/JHEP06(2012)005. arXiv: 1203.0303 [hep-th].
- [170] Davide Gaiotto and Shlomo S. Razamat. “ $\mathcal{N} = 1$ theories of class \mathcal{S}_k ”. In: *JHEP* 07 (2015), p. 073. DOI: 10.1007/JHEP07(2015)073. arXiv: 1503.05159 [hep-th].
- [171] Shlomo S. Razamat, Cumrun Vafa, and Gabi Zafrir. “4d $\mathcal{N} = 1$ from 6d (1, 0)”. In: *JHEP* 04 (2017), p. 064. DOI: 10.1007/JHEP04(2017)064. arXiv: 1610.09178 [hep-th].
- [172] Hee-Cheol Kim et al. “E-String Theory on Riemann Surfaces”. In: *Fortsch. Phys.* 66.1 (2018), p. 1700074. DOI: 10.1002/prop.201700074. arXiv: 1709.02496 [hep-th].
- [173] Hee-Cheol Kim et al. “D-type Conformal Matter and SU/USp Quivers”. In: *JHEP* 06 (2018), p. 058. DOI: 10.1007/JHEP06(2018)058. arXiv: 1802.00620 [hep-th].
- [174] Hee-Cheol Kim et al. “Compactifications of ADE conformal matter on a torus”. In: *JHEP* 09 (2018), p. 110. DOI: 10.1007/JHEP09(2018)110. arXiv: 1806.07620 [hep-th].
- [175] Shlomo S. Razamat and Gabi Zafrir. “Compactification of 6d minimal SCFTs on Riemann surfaces”. In: *Phys. Rev. D* 98.6 (2018), p. 066006. DOI: 10.1103/PhysRevD.98.066006. arXiv: 1806.09196 [hep-th].
- [176] Shlomo S. Razamat and Evyatar Sabag. “SQCD and pairs of pants”. In: *JHEP* 09 (2020), p. 028. DOI: 10.1007/JHEP09(2020)028. arXiv: 2006.03480 [hep-th].
- [177] Chiung Hwang et al. “Rank Q E-string on spheres with flux”. In: *SciPost Phys.* 11.2 (2021), p. 044. DOI: 10.21468/SciPostPhys.11.2.044. arXiv: 2103.09149 [hep-th].
- [178] Shlomo S. Razamat et al. “Aspects of 4d supersymmetric dynamics and geometry”. In: (Mar. 2022). arXiv: 2203.06880 [hep-th].
- [179] Amihay Hanany and Edward Witten. “Type IIB superstrings, BPS monopoles, and three-dimensional gauge dynamics”. In: *Nucl. Phys. B* 492 (1997), pp. 152–190. DOI: 10.1016/S0550-3213(97)00157-0. arXiv: hep-th/9611230.
- [180] Amit Giveon and David Kutasov. “Brane Dynamics and Gauge Theory”. In: *Rev. Mod. Phys.* 71 (1999). Ed. by F. A. Bais et al., pp. 983–1084. DOI: 10.1103/RevModPhys.71.983. arXiv: hep-th/9802067.
- [181] Ofer Aharony and Amihay Hanany. “Branes, superpotentials and superconformal fixed points”. In: *Nucl. Phys. B* 504 (1997), pp. 239–271. DOI: 10.1016/S0550-3213(97)00472-0. arXiv: hep-th/9704170.
- [182] Ofer Aharony, Amihay Hanany, and Barak Kol. “Webs of (p,q) five-branes, five-dimensional field theories and grid diagrams”. In: *JHEP* 01 (1998), p. 002. DOI: 10.1088/1126-6708/1998/01/002. arXiv: hep-th/9710116.
- [183] Francesco Benini, Sergio Benvenuti, and Yuji Tachikawa. “Webs of five-branes and $N=2$ superconformal field theories”. In: *JHEP* 09 (2009), p. 052. DOI: 10.1088/1126-6708/2009/09/052. arXiv: 0906.0359 [hep-th].

- [184] Oren Bergman, Diego Rodríguez-Gómez, and Gabi Zafrir. “5-Brane Webs, Symmetry Enhancement, and Duality in 5d Supersymmetric Gauge Theory”. In: *JHEP* 03 (2014), p. 112. DOI: 10.1007/JHEP03(2014)112. arXiv: 1311.4199 [hep-th].
- [185] Gabi Zafrir. “Duality and enhancement of symmetry in 5d gauge theories”. In: *JHEP* 12 (2014), p. 116. DOI: 10.1007/JHEP12(2014)116. arXiv: 1408.4040 [hep-th].
- [186] Oren Bergman and Gabi Zafrir. “Lifting 4d dualities to 5d”. In: *JHEP* 04 (2015), p. 141. DOI: 10.1007/JHEP04(2015)141. arXiv: 1410.2806 [hep-th].
- [187] Oren Bergman and Gabi Zafrir. “5d fixed points from brane webs and O7-planes”. In: *JHEP* 12 (2015), p. 163. DOI: 10.1007/JHEP12(2015)163. arXiv: 1507.03860 [hep-th].
- [188] Sung-Soo Kim, Masato Taki, and Futoshi Yagi. “Tao Probing the End of the World”. In: *PTEP* 2015.8 (2015), 083B02. DOI: 10.1093/ptep/ptv108. arXiv: 1504.03672 [hep-th].
- [189] Hirotaka Hayashi et al. “A new 5d description of 6d D-type minimal conformal matter”. In: *JHEP* 08 (2015), p. 097. DOI: 10.1007/JHEP08(2015)097. arXiv: 1505.04439 [hep-th].
- [190] Hirotaka Hayashi et al. “6d SCFTs, 5d Dualities and Tao Web Diagrams”. In: *JHEP* 05 (2019), p. 203. DOI: 10.1007/JHEP05(2019)203. arXiv: 1509.03300 [hep-th].
- [191] Gabi Zafrir. “Brane webs, 5d gauge theories and 6d $\mathcal{N} = (1, 0)$ SCFT’s”. In: *JHEP* 12 (2015), p. 157. DOI: 10.1007/JHEP12(2015)157. arXiv: 1509.02016 [hep-th].
- [192] Gabi Zafrir. “Brane webs and O5-planes”. In: *JHEP* 03 (2016), p. 109. DOI: 10.1007/JHEP03(2016)109. arXiv: 1512.08114 [hep-th].
- [193] Hirotaka Hayashi et al. “More on 5d descriptions of 6d SCFTs”. In: *JHEP* 10 (2016), p. 126. DOI: 10.1007/JHEP10(2016)126. arXiv: 1512.08239 [hep-th].
- [194] Ilka Brunner and Andreas Karch. “Branes and six-dimensional fixed points”. In: *Phys. Lett. B* 409 (1997), pp. 109–116. DOI: 10.1016/S0370-2693(97)00935-0. arXiv: hep-th/9705022.
- [195] Ilka Brunner and Andreas Karch. “Branes at orbifolds versus Hanany Witten in six-dimensions”. In: *JHEP* 03 (1998), p. 003. DOI: 10.1088/1126-6708/1998/03/003. arXiv: hep-th/9712143.
- [196] Amihay Hanany and Alberto Zaffaroni. “Branes and six-dimensional supersymmetric theories”. In: *Nucl. Phys. B* 529 (1998), pp. 180–206. DOI: 10.1016/S0550-3213(98)00355-1. arXiv: hep-th/9712145.
- [197] Andreas Karch. “More on N=1 selfdualities and exceptional gauge groups”. In: *Phys. Lett. B* 405 (1997), pp. 280–286. DOI: 10.1016/S0370-2693(97)00604-7. arXiv: hep-th/9702179.
- [198] Shlomo S. Razamat, Orr Sela, and Gabi Zafrir. “Curious patterns of IR symmetry enhancement”. In: *JHEP* 10 (2018), p. 163. DOI: 10.1007/JHEP10(2018)163. arXiv: 1809.00541 [hep-th].

- [199] Shlomo S. Razamat, Orr Sela, and Gabi Zafrir. “Between Symmetry and Duality in Supersymmetric Quantum Field Theories”. In: *Phys. Rev. Lett.* 120.7 (2018), p. 071604. DOI: 10.1103/PhysRevLett.120.071604. arXiv: 1711.02789 [hep-th].
- [200] Orr Sela and Gabi Zafrir. “Symmetry enhancement in 4d Spin(n) gauge theories and compactification from 6d”. In: *JHEP* 12 (2019), p. 052. DOI: 10.1007/JHEP12(2019)052. arXiv: 1910.03629 [hep-th].
- [201] Chiung Hwang, Sara Pasquetti, and Matteo Sacchi. “Flips, dualities and symmetry enhancements”. In: *JHEP* 05 (2021), p. 094. DOI: 10.1007/JHEP05(2021)094. arXiv: 2010.10446 [hep-th].
- [202] Abhijit Gadde, Shlomo S. Razamat, and Brian Willett. ““Lagrangian” for a Non-Lagrangian Field Theory with $\mathcal{N} = 2$ Supersymmetry”. In: *Phys. Rev. Lett.* 115.17 (2015), p. 171604. DOI: 10.1103/PhysRevLett.115.171604. arXiv: 1505.05834 [hep-th].
- [203] Kazunobu Maruyoshi and Jaewon Song. “Enhancement of Supersymmetry via Renormalization Group Flow and the Superconformal Index”. In: *Phys. Rev. Lett.* 118.15 (2017), p. 151602. DOI: 10.1103/PhysRevLett.118.151602. arXiv: 1606.05632 [hep-th].
- [204] Kazunobu Maruyoshi and Jaewon Song. “ $\mathcal{N} = 1$ deformations and RG flows of $\mathcal{N} = 2$ SCFTs”. In: *JHEP* 02 (2017), p. 075. DOI: 10.1007/JHEP02(2017)075. arXiv: 1607.04281 [hep-th].
- [205] Prarit Agarwal, Kazunobu Maruyoshi, and Jaewon Song. “ $\mathcal{N} = 1$ Deformations and RG flows of $\mathcal{N} = 2$ SCFTs, part II: non-principal deformations”. In: *JHEP* 12 (2016). [Addendum: *JHEP* 04, 113 (2017)], p. 103. DOI: 10.1007/JHEP12(2016)103. arXiv: 1610.05311 [hep-th].
- [206] Prarit Agarwal, Antonio Sciarappa, and Jaewon Song. “ $\mathcal{N} = 1$ Lagrangians for generalized Argyres-Douglas theories”. In: *JHEP* 10 (2017), p. 211. DOI: 10.1007/JHEP10(2017)211. arXiv: 1707.04751 [hep-th].
- [207] Simone Giacomelli. “RG flows with supersymmetry enhancement and geometric engineering”. In: *JHEP* 06 (2018), p. 156. DOI: 10.1007/JHEP06(2018)156. arXiv: 1710.06469 [hep-th].
- [208] Prarit Agarwal, Kazunobu Maruyoshi, and Jaewon Song. “A “Lagrangian” for the E_7 superconformal theory”. In: *JHEP* 05 (2018), p. 193. DOI: 10.1007/JHEP05(2018)193. arXiv: 1802.05268 [hep-th].
- [209] Prarit Agarwal. “On dimensional reduction of 4d $\mathcal{N} = 1$ Lagrangians for Argyres-Douglas theories”. In: *JHEP* 03 (2019), p. 011. DOI: 10.1007/JHEP03(2019)011. arXiv: 1809.10534 [hep-th].
- [210] Gabi Zafrir. “An $\mathcal{N} = 1$ Lagrangian for the rank 1 E_6 superconformal theory”. In: *JHEP* 12 (2020), p. 098. DOI: 10.1007/JHEP12(2020)098. arXiv: 1912.09348 [hep-th].

- [211] Ivan Garozzo et al. “Symmetry enhancement and duality walls in 5d gauge theories”. In: *JHEP* 06 (2020), p. 159. DOI: 10.1007/JHEP06(2020)159. arXiv: 2003.07373 [hep-th].
- [212] Gabi Zafrir. “An $\mathcal{N} = 1$ Lagrangian for an $\mathcal{N} = 3$ SCFT”. In: *JHEP* 01 (2021), p. 062. DOI: 10.1007/JHEP01(2021)062. arXiv: 2007.14955 [hep-th].
- [213] Monica Jinwoo Kang et al. “Emergent N=4 supersymmetry from N=1”. In: (Feb. 2023). arXiv: 2302.06622 [hep-th].
- [214] Sergio Cecotti and Michele Del Zotto. “Infinitely many N=2 SCFT with ADE flavor symmetry”. In: *JHEP* 01 (2013), p. 191. DOI: 10.1007/JHEP01(2013)191. arXiv: 1210.2886 [hep-th].
- [215] Nima Arkani-Hamed and Hitoshi Murayama. “Holomorphy, rescaling anomalies and exact beta functions in supersymmetric gauge theories”. In: *JHEP* 06 (2000), p. 030. DOI: 10.1088/1126-6708/2000/06/030. arXiv: hep-th/9707133.
- [216] Markus A. Luty and Washington Taylor. “Varieties of vacua in classical supersymmetric gauge theories”. In: *Phys. Rev. D* 53 (1996), pp. 3399–3405. DOI: 10.1103/PhysRevD.53.3399. arXiv: hep-th/9506098.
- [217] Ofer Aharony et al. “Aspects of N=2 supersymmetric gauge theories in three-dimensions”. In: *Nucl. Phys. B* 499 (1997), pp. 67–99. DOI: 10.1016/S0550-3213(97)00323-4. arXiv: hep-th/9703110.
- [218] Kenneth Intriligator and Nathan Seiberg. “Aspects of 3d N=2 Chern-Simons-Matter Theories”. In: *JHEP* 07 (2013), p. 079. DOI: 10.1007/JHEP07(2013)079. arXiv: 1305.1633 [hep-th].
- [219] Antonio Amariti, Domenico Orlando, and Susanne Reffert. “String theory and the 4D/3D reduction of Seiberg duality. A review”. In: *Phys. Rept.* 705-706 (2017), pp. 1–53. DOI: 10.1016/j.physrep.2017.08.002. arXiv: 1611.04883 [hep-th].
- [220] B. M. Zupnik and D. G. Pak. “Topologically Massive Gauge Theories in Superspace”. In: *Sov. Phys. J.* 31 (1988), pp. 962–965. DOI: 10.1007/BF01101161.
- [221] E. A. Ivanov. “Chern-Simons matter systems with manifest N=2 supersymmetry”. In: *Phys. Lett. B* 268 (1991), pp. 203–208. DOI: 10.1016/0370-2693(91)90804-Y.
- [222] S. James Gates Jr. and Hitoshi Nishino. “Remarks on the N=2 supersymmetric Chern-Simons theories”. In: *Phys. Lett. B* 281 (1992), pp. 72–80. DOI: 10.1016/0370-2693(92)90277-B.
- [223] Vadim Borokhov, Anton Kapustin, and Xin-kai Wu. “Topological disorder operators in three-dimensional conformal field theory”. In: *JHEP* 11 (2002), p. 049. DOI: 10.1088/1126-6708/2002/11/049. arXiv: hep-th/0206054.
- [224] Vadim Borokhov, Anton Kapustin, and Xin-kai Wu. “Monopole operators and mirror symmetry in three-dimensions”. In: *JHEP* 12 (2002), p. 044. DOI: 10.1088/1126-6708/2002/12/044. arXiv: hep-th/0207074.

- [225] Anton Kapustin. “Wilson-’t Hooft operators in four-dimensional gauge theories and S-duality”. In: *Phys. Rev. D* 74 (2006), p. 025005. DOI: 10.1103/PhysRevD.74.025005. arXiv: hep-th/0501015.
- [226] Ian Affleck, Jeffrey A. Harvey, and Edward Witten. “Instantons and (Super)Symmetry Breaking in (2+1)-Dimensions”. In: *Nucl. Phys. B* 206 (1982), pp. 413–439. DOI: 10.1016/0550-3213(82)90277-2.
- [227] Wolfgang Lerche, Cumrun Vafa, and Nicholas P. Warner. “Chiral Rings in N=2 Superconformal Theories”. In: *Nucl. Phys. B* 324 (1989), pp. 427–474. DOI: 10.1016/0550-3213(89)90474-4.
- [228] Freddy Cachazo et al. “Chiral rings and anomalies in supersymmetric gauge theory”. In: *JHEP* 12 (2002), p. 071. DOI: 10.1088/1126-6708/2002/12/071. arXiv: hep-th/0211170.
- [229] Clay Cordova et al. “Snowmass White Paper: Generalized Symmetries in Quantum Field Theory and Beyond”. In: *Snowmass 2021*. May 2022. arXiv: 2205.09545 [hep-th].
- [230] Adel Bilal. “Lectures on Anomalies”. In: (Feb. 2008). arXiv: 0802.0634 [hep-th].
- [231] Naoki Yamatsu. “Finite-Dimensional Lie Algebras and Their Representations for Unified Model Building”. In: (Nov. 2015). arXiv: 1511.08771 [hep-ph].
- [232] Kenneth A. Intriligator and Brian Wecht. “The Exact superconformal R symmetry maximizes a”. In: *Nucl. Phys. B* 667 (2003), pp. 183–200. DOI: 10.1016/S0550-3213(03)00459-0. arXiv: hep-th/0304128.
- [233] Stanley Deser and A. Schwimmer. “Geometric classification of conformal anomalies in arbitrary dimensions”. In: *Phys. Lett. B* 309 (1993), pp. 279–284. DOI: 10.1016/0370-2693(93)90934-A. arXiv: hep-th/9302047.
- [234] D. Anselmi et al. “Nonperturbative formulas for central functions of supersymmetric gauge theories”. In: *Nucl. Phys. B* 526 (1998), pp. 543–571. DOI: 10.1016/S0550-3213(98)00278-8. arXiv: hep-th/9708042.
- [235] Philippe Pouliot. “Molien function for duality”. In: *JHEP* 01 (1999), p. 021. DOI: 10.1088/1126-6708/1999/01/021. arXiv: hep-th/9812015.
- [236] F. A. Dolan and H. Osborn. “Applications of the Superconformal Index for Protected Operators and q-Hypergeometric Identities to N=1 Dual Theories”. In: *Nucl. Phys. B* 818 (2009), pp. 137–178. DOI: 10.1016/j.nuclphysb.2009.01.028. arXiv: 0801.4947 [hep-th].
- [237] D. Amati et al. “Nonperturbative Aspects in Supersymmetric Gauge Theories”. In: *Phys. Rept.* 162 (1988), pp. 169–248. DOI: 10.1016/0370-1573(88)90182-2.
- [238] V. P. Spiridonov and G. S. Vartanov. “Superconformal indices for N = 1 theories with multiple duals”. In: *Nucl. Phys. B* 824 (2010), pp. 192–216. DOI: 10.1016/j.nuclphysb.2009.08.022. arXiv: 0811.1909 [hep-th].

- [239] Ian Affleck, Michael Dine, and Nathan Seiberg. “Dynamical Supersymmetry Breaking in Supersymmetric QCD”. In: *Nucl. Phys. B* 241 (1984), pp. 493–534. DOI: 10.1016/0550-3213(84)90058-0.
- [240] P. Pouliot. “Chiral duals of nonchiral SUSY gauge theories”. In: *Phys. Lett. B* 359 (1995), pp. 108–113. DOI: 10.1016/0370-2693(95)01034-N. arXiv: hep-th/9507018.
- [241] Lea Bottini. “Dualities in four dimensional supersymmetric gauge theories”. In: *Master Thesis, Università di Milano-Bicocca, unpublished* ().
- [242] Leonardo Rastelli and Shlomo S. Razamat. “The supersymmetric index in four dimensions”. In: *J. Phys. A* 50.44 (2017), p. 443013. DOI: 10.1088/1751-8121/aa76a6. arXiv: 1608.02965 [hep-th].
- [243] Sergio Benvenuti and Gabriele Lo Monaco. “Sawing an adjoint: sequential deconfinement in ortho-symplectic gauge theories”. In: (). eprint: toappear.
- [244] Antonio Amariti, Domenico Orlando, and Susanne Reffert. “Monopole Quivers and new 3D N=2 dualities”. In: *Nucl. Phys. B* 924 (2017), pp. 153–177. DOI: 10.1016/j.nuclphysb.2017.09.008. arXiv: 1705.09297 [hep-th].
- [245] Sergio Benvenuti, Ivan Garozzo, and Gabriele Lo Monaco. “Monopoles and dualities in 3d $\mathcal{N} = 2$ quivers”. In: *JHEP* 10 (2021), p. 191. DOI: 10.1007/JHEP10(2021)191. arXiv: 2012.08556 [hep-th].
- [246] Csaba Csaki and Hitoshi Murayama. “New confining N=1 supersymmetric gauge theories”. In: *Phys. Rev. D* 59 (1999), p. 065001. DOI: 10.1103/PhysRevD.59.065001. arXiv: hep-th/9810014.
- [247] D. Kutasov, A. Schwimmer, and N. Seiberg. “Chiral rings, singularity theory and electric - magnetic duality”. In: *Nucl. Phys. B* 459 (1996), pp. 455–496. DOI: 10.1016/0550-3213(95)00599-4. arXiv: hep-th/9510222.
- [248] Ashoke Sen. “F theory and orientifolds”. In: *Nucl. Phys. B* 475 (1996), pp. 562–578. DOI: 10.1016/0550-3213(96)00347-1. arXiv: hep-th/9605150.
- [249] Gabi Zafrir. “On the torus compactifications of Z_2 orbifolds of E-string theories”. In: *JHEP* 10 (2019), p. 040. DOI: 10.1007/JHEP10(2019)040. arXiv: 1809.04260 [hep-th].
- [250] Davide Gaiotto and Hee-Cheol Kim. “Duality walls and defects in 5d $\mathcal{N} = 1$ theories”. In: *JHEP* 01 (2017), p. 019. DOI: 10.1007/JHEP01(2017)019. arXiv: 1506.03871 [hep-th].
- [251] Ibrahima Bah et al. “4d $\mathcal{N} = 1$ from 6d $\mathcal{N} = (1, 0)$ on a torus with fluxes”. In: *JHEP* 06 (2017), p. 022. DOI: 10.1007/JHEP06(2017)022. arXiv: 1702.04740 [hep-th].
- [252] Shlomo S. Razamat, Evyatar Sabag, and Gabi Zafrir. “From 6d flows to 4d flows”. In: *JHEP* 12 (2019), p. 108. DOI: 10.1007/JHEP12(2019)108. arXiv: 1907.04870 [hep-th].
- [253] Shlomo S. Razamat and Evyatar Sabag. “Sequences of 6d SCFTs on generic Riemann surfaces”. In: *JHEP* 01 (2020), p. 086. DOI: 10.1007/JHEP01(2020)086. arXiv: 1910.03603 [hep-th].

- [254] Evyatar Sabag and Matteo Sacchi. “A 5d perspective on the compactifications of 6d SCFTs to 4d $\mathcal{N} = 1$ SCFTs”. In: (Aug. 2022). arXiv: 2208.03331 [hep-th].
- [255] Monica Jinwoo Kang, Craig Lawrie, and Jaewon Song. “Infinitely many 4D $\mathcal{N}=2$ SCFTs with $a=c$ and beyond”. In: *Phys. Rev. D* 104.10 (2021), p. 105005. DOI: 10.1103/PhysRevD.104.105005. arXiv: 2106.12579 [hep-th].
- [256] Monica Jinwoo Kang et al. “Infinitely many 4D $\mathcal{N}=1$ SCFTs with $a=c$ ”. In: *Phys. Rev. D* 105.12 (2022), p. 126006. DOI: 10.1103/PhysRevD.105.126006. arXiv: 2111.12092 [hep-th].
- [257] Monica Jinwoo Kang et al. “Higgs branch, Coulomb branch, and Hall-Littlewood index”. In: *Phys. Rev. D* 106.10 (2022), p. 106021. DOI: 10.1103/PhysRevD.106.106021. arXiv: 2207.05764 [hep-th].
- [258] Monica Jinwoo Kang et al. “Operator spectroscopy for 4D SCFTs with $a=c$ ”. In: *Phys. Rev. D* 107.6 (2023), p. 066018. DOI: 10.1103/PhysRevD.107.066018. arXiv: 2210.06497 [hep-th].
- [259] Kazunobu Maruyoshi, Emily Nardoni, and Jaewon Song. “Dualities of Adjoint SQCD and Supersymmetry Enhancement”. In: (June 2023). arXiv: 2306.08867 [hep-th].
- [260] Matthew Buican and Takahiro Nishinaka. “Argyres–Douglas theories, S^1 reductions, and topological symmetries”. In: *J. Phys. A* 49.4 (2016), p. 045401. DOI: 10.1088/1751-8113/49/4/045401. arXiv: 1505.06205 [hep-th].
- [261] Simone Giacomelli, Noppadol Mekareeya, and Matteo Sacchi. “New aspects of Argyres–Douglas theories and their dimensional reduction”. In: *JHEP* 03 (2021), p. 242. DOI: 10.1007/JHEP03(2021)242. arXiv: 2012.12852 [hep-th].
- [262] Cyril Closset et al. “5d and 4d SCFTs: Canonical Singularities, Trinions and S-Dualities”. In: *JHEP* 05 (2021), p. 274. DOI: 10.1007/JHEP05(2021)274. arXiv: 2012.12827 [hep-th].
- [263] Robert G. Leigh and Matthew J. Strassler. “Exactly marginal operators and duality in four-dimensional $\mathcal{N}=1$ supersymmetric gauge theory”. In: *Nucl. Phys. B* 447 (1995), pp. 95–136. DOI: 10.1016/0550-3213(95)00261-P. arXiv: hep-th/9503121.
- [264] Matteo Sacchi, Orr Sela, and Gabi Zafrir. “Compactifying 5d superconformal field theories to 3d”. In: *JHEP* 09 (2021), p. 149. DOI: 10.1007/JHEP09(2021)149. arXiv: 2105.01497 [hep-th].
- [265] Matteo Sacchi, Orr Sela, and Gabi Zafrir. “On the 3d compactifications of 5d SCFTs associated with $SU(N + 1)$ gauge theories”. In: *JHEP* 05 (2022), p. 053. DOI: 10.1007/JHEP05(2022)053. arXiv: 2111.12745 [hep-th].
- [266] Matteo Sacchi, Orr Sela, and Gabi Zafrir. “Trinions for the 3d compactification of the 5d rank 1 E_{N_f+1} SCFTs”. In: (Jan. 2023). arXiv: 2301.06561 [hep-th].
- [267] Matteo Sacchi, Orr Sela, and Gabi Zafrir. “5d to 3d compactifications and discrete anomalies”. In: (May 2023). arXiv: 2305.08185 [hep-th].

- [268] Davide Gaiotto et al. “Generalized Global Symmetries”. In: *JHEP* 02 (2015), p. 172. DOI: 10.1007/JHEP02(2015)172. arXiv: 1412.5148 [hep-th].
- [269] V. P. Spiridonov and G. S. Vartanov. “Vanishing superconformal indices and the chiral symmetry breaking”. In: *JHEP* 06 (2014), p. 062. DOI: 10.1007/JHEP06(2014)062. arXiv: 1402.2312 [hep-th].
- [270] Simone Giacomelli et al. “Probing bad theories with the dualization algorithm I”. In: (Sept. 2023). arXiv: 2309.05326 [hep-th].
- [271] Davide Gaiotto, Leonardo Rastelli, and Shlomo S. Razamat. “Bootstrapping the superconformal index with surface defects”. In: *JHEP* 01 (2013), p. 022. DOI: 10.1007/JHEP01(2013)022. arXiv: 1207.3577 [hep-th].
- [272] Barak Kol. “On conformal deformations”. In: *JHEP* 09 (2002), p. 046. DOI: 10.1088/1126-6708/2002/09/046. arXiv: hep-th/0205141.
- [273] Sergio Benvenuti and Amihay Hanany. “Conformal manifolds for the conifold and other toric field theories”. In: *JHEP* 08 (2005), p. 024. DOI: 10.1088/1126-6708/2005/08/024. arXiv: hep-th/0502043.
- [274] Daniel Green et al. “Exactly Marginal Deformations and Global Symmetries”. In: *JHEP* 06 (2010), p. 106. DOI: 10.1007/JHEP06(2010)106. arXiv: 1005.3546 [hep-th].
- [275] Barak Kol. “On Conformal Deformations II”. In: (May 2010). arXiv: 1005.4408 [hep-th].
- [276] Dan Xie, Wenbin Yan, and Shing-Tung Yau. “Chiral algebra of the Argyres-Douglas theory from M5 branes”. In: *Phys. Rev. D* 103.6 (2021), p. 065003. DOI: 10.1103/PhysRevD.103.065003. arXiv: 1604.02155 [hep-th].
- [277] Dan Xie and Shing-Tung Yau. “4d N=2 SCFT and singularity theory Part I: Classification”. In: (Oct. 2015). arXiv: 1510.01324 [hep-th].
- [278] Abhijit Gadde et al. “Gauge Theories and Macdonald Polynomials”. In: *Commun. Math. Phys.* 319 (2013), pp. 147–193. DOI: 10.1007/s00220-012-1607-8. arXiv: 1110.3740 [hep-th].
- [279] Jaewon Song, Dan Xie, and Wenbin Yan. “Vertex operator algebras of Argyres-Douglas theories from M5-branes”. In: *JHEP* 12 (2017), p. 123. DOI: 10.1007/JHEP12(2017)123. arXiv: 1706.01607 [hep-th].