

TOPICAL REVIEW • OPEN ACCESS

## The 2021 room-temperature superconductivity roadmap

To cite this article: Boeri Lilia *et al* 2022 *J. Phys.: Condens. Matter* **34** 183002

View the [article online](#) for updates and enhancements.

You may also like

- [Coherent-scatterer enhancement and Klein-tunneling suppression by potential barriers in gapped graphene with chirality-time-reversal symmetry](#)  
Farhana Anwar, Andrii Iurov, Danhong Huang *et al.*
- [Black phosphorus for near-infrared ultrafast lasers in the spatial/temporal domain](#)  
Qiang Yu, Kun Guo, Yongping Dai *et al.*
- [Transport properties of Heusler compounds and alloys](#)  
Snehashish Chatterjee, Souvik Chatterjee, Saurav Giri *et al.*



**IOP | ebooks™**

Bringing together innovative digital publishing with leading authors from the global scientific community.

Start exploring the collection—download the first chapter of every title for free.

## Topical Review

# The 2021 room-temperature superconductivity roadmap

Boeri Lilia<sup>1,29,\*</sup> , Richard Hennig<sup>2,29,\*</sup> , Peter Hirschfeld<sup>3,29,\*</sup> ,  
Gianni Profeta<sup>4,29,\*</sup> , Antonio Sanna<sup>5,29,\*</sup> , Eva Zurek<sup>6,29,\*</sup> ,  
Warren E Pickett<sup>7</sup> , Maximilian Amsler<sup>8,9</sup> , Ranga Dias<sup>10</sup> ,  
Mikhail I Eremets<sup>11</sup> , Christoph Heil<sup>12</sup> , Russell J Hemley<sup>13</sup> ,  
Hanyu Liu<sup>14</sup> , Yanming Ma<sup>14</sup> , Carlo Pierleoni<sup>3</sup> ,  
Aleksy N Kolmogorov<sup>15</sup> , Nikita Rybin<sup>15</sup> , Dmitry Novoselov<sup>17</sup> ,  
Vladimir Anisimov<sup>17</sup> , Artem R Oganov<sup>16</sup> , Chris J Pickard<sup>18</sup> ,  
Tiange Bi<sup>6</sup> , Ryotaro Arita<sup>19,20</sup> , Ion Errea<sup>21</sup> , Camilla Pellegrini<sup>22</sup> ,  
Ryan Requist<sup>5,23</sup> , E K U Gross<sup>5,23</sup> , Elena Roxana Margine<sup>15</sup> ,  
Stephen R Xie<sup>3</sup> , Yundi Quan<sup>3</sup> , Ajinkya Hire<sup>3</sup> , Laura Fanfarillo<sup>3,24</sup> ,  
G R Stewart<sup>3</sup> , J J Hamlin<sup>3</sup> , Valentin Stanev<sup>25</sup> , Renato S Gonnelli<sup>26</sup> ,  
Erik Piatti<sup>26</sup> , Davide Romanin<sup>27</sup> , Dario Daghero<sup>26</sup> , and  
Roser Valenti<sup>28</sup> 

<sup>1</sup> Physics Department, Sapienza University and Enrico Fermi Research Center, Rome, Italy

<sup>2</sup> Department of Material Science and Engineering and Quantum Theory Project, University of Florida, Gainesville 32611, United States of America

<sup>3</sup> Department of Physics, University of Florida, Gainesville, FL 32611, United States of America

<sup>4</sup> University of L'Aquila, Italy

<sup>5</sup> Max Planck Institute of Microstructure Physics, Halle, Germany

<sup>6</sup> University at Buffalo, SUNY, United States of America

<sup>7</sup> University of California Davis, United States of America

<sup>8</sup> Department of Chemistry and Biochemistry, University of Bern, Freiestrasse 3, CH-3012 Bern, Switzerland

<sup>9</sup> Department of Materials Science and Engineering, Cornell University, Ithaca, NY 14853, United States of America

<sup>10</sup> University of Rochester, United States of America

<sup>11</sup> Max Planck Institute for Chemistry, Mainz, Germany

<sup>12</sup> Graz University of Technology, Austria

<sup>13</sup> University of Illinois at Chicago, United States of America

<sup>14</sup> Jilin University, People's Republic of China

<sup>15</sup> Binghamton University, United States of America

<sup>16</sup> Skolkovo Institute of Science and Technology, Russia

<sup>17</sup> Ural Federal University, Yekaterinburg, Russia

<sup>18</sup> Cambridge University, United Kingdom

<sup>19</sup> University of Tokyo, Japan

<sup>20</sup> RIKEN, Japan

<sup>21</sup> University of the Basque Country, Spain

<sup>22</sup> University of Perugia, Italy

<sup>23</sup> Hebrew University of Jerusalem, Israel

<sup>24</sup> Scuola Internazionale Superiore di Studi Avanzati (SISSA), Via Bonomea 265, 34136 Trieste, Italy

<sup>25</sup> University of Maryland, United States of America

<sup>29</sup> Guest editors of the roadmap.

\* Author to whom any correspondence should be addressed.



Original content from this work may be used under the terms of the [Creative Commons Attribution 4.0 licence](https://creativecommons.org/licenses/by/4.0/). Any further distribution of this work must maintain attribution to the author(s) and the title of the work, journal citation and DOI.

<sup>26</sup> Politecnico di Torino, Italy<sup>27</sup> Sorbonne Université, France<sup>28</sup> Goethe University Frankfurt, GermanyE-mail: [lilia.boeri@uniroma1.it](mailto:lilia.boeri@uniroma1.it), [rhennig@mse.ufl.edu](mailto:rhennig@mse.ufl.edu), [pjh@phys.ufl.edu](mailto:pjh@phys.ufl.edu), [gianni.profeta@aquila.infn.it](mailto:gianni.profeta@aquila.infn.it), [sanna@mpi-halle.mpg.de](mailto:sanna@mpi-halle.mpg.de) and [ezurek@buffalo.edu](mailto:ezurek@buffalo.edu)

Received 5 May 2021, revised 16 July 2021

Accepted for publication 20 September 2021

Published 3 March 2022



## Abstract

Designing materials with advanced functionalities is the main focus of contemporary solid-state physics and chemistry. Research efforts worldwide are funneled into a few high-end goals, one of the oldest, and most fascinating of which is the search for an ambient temperature superconductor (A-SC). The reason is clear: superconductivity at ambient conditions implies being able to handle, measure and access a single, coherent, macroscopic quantum mechanical state without the limitations associated with cryogenics and pressurization. This would not only open exciting avenues for fundamental research, but also pave the road for a wide range of technological applications, affecting strategic areas such as energy conservation and climate change. In this roadmap we have collected contributions from many of the main actors working on superconductivity, and asked them to share their personal viewpoint on the field. The hope is that this article will serve not only as an instantaneous picture of the status of research, but also as a true roadmap defining the main long-term theoretical and experimental challenges that lie ahead. Interestingly, although the current research in superconductor design is dominated by conventional (phonon-mediated) superconductors, there seems to be a widespread consensus that achieving A-SC may require different pairing mechanisms.

*In memoriam, to Neil Ashcroft, who inspired us all.*

Keywords: superconductor, superconductivity, hydrides, electron–phonon interaction, , crystal structure prediction, novel superconductors

(Some figures may appear in colour only in the online journal)

## Contents

1. Preface to the 2021 room-temperature superconductivity roadmap	3	4.2. Big research issues and challenges	10
I. Introduction	5	4.3. Advances in science and technology to meet challenges	11
2. Historical perspectives on the RTS roadmap	5	4.4. Concluding remarks	11
2.1. Status: decades of chagrin; recent elation	5	5. Bonding and electron–phonon coupling in high-pressure hydrides	11
2.2. Current and future challenges: a revisionist approach to RTS	6	5.1. Status	11
2.3. Advances to meet challenges: recognize the tyranny of $\lambda$	6	5.2. Current and future challenges	12
2.4. Concluding remarks: the known unknown	7	5.3. Advances in science and technology to meet challenges	12
II. Hydrogen-rich solids	8	5.4. Concluding remarks	13
3. Fabrication and stabilization of superconducting superhydrides	8	6. Toward hot superconductivity	13
3.1. Status	8	6.1. Status	13
3.2. Current and future challenges	9	6.2. Current and future challenges	13
3.3. Advances in science and technology to meet challenges	9	6.3. Advances in science and technology to meet challenges	15
3.4. Concluding remarks	9	6.4. Concluding remarks	15
4. High temperature superconductivity in hydrides	10	7. High pressure hydrogen: a theoretical challenge from the simplest element	15
4.1. Brief history and status	10	7.1. The phase diagram	15
		7.2. A challenge for theory	16

7.3. Conclusions and perspectives	17	15.2. Current and future challenges	32
III. Crystal structure prediction methods	18	15.3. Advances in science and technology to meet challenges	32
8. Accelerating the prediction of superconducting complex hydrides	18	15.4. Concluding remarks	32
8.1. Status	18	16. Extending the predictive power of DFT for superconductors: toward nonadiabatic electron–phonon coupling	33
8.2. Current and future challenges	18	16.1. Status	33
8.3. Advances in science and technology to meet challenges	18	16.2. Current and future challenges	33
8.4. Concluding remarks	20	16.3. Advances in science and technology to meet challenges	34
9. Ab-initio structure search orientated discovery of high temperature superconductivity in pressure-stabilized superhydrides	20	16.4. Concluding remarks	34
9.1. Status	20	17. Modeling superconducting properties with the Eliashberg formalism	35
9.2. Current and future challenges	20	17.1. Status	35
9.3. Advances in science and technology to meet challenges	21	17.2. Current and future challenges	36
9.4. Concluding remarks	21	17.3. Advances in science and technology to meet challenges	36
10. Ab initio structure prediction accelerated with machine learning interatomic potentials	21	17.4. Concluding remarks	36
10.1. Status	21	V. Artificial intelligence applied to superconductor research	36
10.2. Current and future challenges	21	18. Toward high-throughput superconductor discovery via machine learning	37
10.3. Advances in science and technology to meet challenges	22	18.1. Status	37
10.4. Concluding remarks	23	18.2. Current and future challenges	38
11. Searching for high-temperature superconductors at normal pressure	23	18.3. Advances in science and technology to meet challenges	38
11.1. Status	23	18.4. Concluding remarks	39
11.2. Current and future challenges	23	19. Artificial intelligence in the search for new superconductors	40
11.3. Advances in science and technology to meet challenges	24	19.1. Status	40
11.4. Concluding remarks	24	19.2. Current and future challenges	40
12. Pushing the limits of structure prediction in the search for superconducting hydrides	25	19.3. Advances in science and technology to meet challenges	40
12.1. Status	25	19.4. Concluding remarks	41
12.2. Current and future challenges	25	VI. Other (non-hydride) superconductors	41
12.3. Advances in science and technology to meet challenges	26	20. Is protonation (hydrogenation) the future of conventional superconductivity at room pressure?	41
12.4. Concluding remarks	26	20.1. Status	41
13. Chemical principles to guide the discovery of ever-more complex superconducting hydrides	27	20.2. Current and future challenges	41
13.1. Status	27	20.3. Advances in science and technology to meet challenges	42
13.2. Current and future challenges	28	20.4. Concluding remarks	43
13.3. Advances in science and technology to meet challenges	28	21. Predicting unconventional superconductors from first principles	43
13.4. Concluding remarks	28	21.1. Status	43
IV. Ab initio theory of superconductivity	28	21.2. Current and future challenges	43
14. Ab initio Eliashberg calculations	29	21.3. Advances in science and technology to meet challenges	44
14.1. Status	29	21.4. Concluding remarks	44
14.2. Current and future challenges	29	Appendix A. Q&A on current and future challenges in room-temperature superconductivity: a virtual round table	44
14.3. Advances in science and technology to meet challenges	30	References	47
14.4. Concluding remarks	30		
15. High-temperature hydrogen-based superconductors: a quantum energy landscape	31		
15.1. Status	31		

## 1. Preface to the 2021 room-temperature superconductivity roadmap

Designing materials with advanced functionalities is the main focus of contemporary solid-state physics and chemistry. Research efforts worldwide are funneled into a few high-end goals, one of the oldest, and most fascinating of which is the search for an ambient temperature superconductor (A-SC).

The reason is clear: superconductivity at ambient conditions implies being able to handle, measure and access a single, coherent, macroscopic quantum mechanical state without the limitations associated with cryogenics and pressurization. This would not only open exciting avenues for fundamental research, but also pave the road for a wide range of technological applications, affecting strategic areas such as energy conservation and climate change.

Recently, the dream of A-SC has been revived by the discovery of superconductivity at 203 K in the high-pressure superhydride  $\text{SH}_3$ , followed quickly by  $\text{LaH}_{10}$  with critical temperature of 260 K, and five years later by the report of room-temperature superconductivity (RTSC) in C-S-H. These discoveries marked a milestone in superconductivity history not only for achieving the record critical temperatures, but also for an unprecedented synergy between theory and experiment in the discovery of superconductors. The momentum derived by the superhydride breakthroughs is now driving an intense debate among different fields to define new search strategies and methodological improvements to overcome the remaining obstacle to A-SC, i.e. the reduction of operation pressure. In this roadmap we have collected contributions from many of the main actors working on superconductivity at high pressures, and asked them to share their personal viewpoint on the field. The hope is that this article will serve not only as an instantaneous picture of the status of research, but also as a true roadmap defining the main long-term theoretical and experimental challenges that lie ahead. Interestingly, although the current research in superconductor design is dominated by conventional (phonon-mediated) superconductors, there seems to be a widespread consensus that achieving A-SC may require different pairing mechanisms.

All in all, it emerges from our collection that the main future challenges for the field fall into three broad categories: (i) improving the current theoretical description of solids and superconductivity, (ii) extending the domain of methods for computational material design beyond the current limits dictated by computational efficiency and (iii) developing new experimental methodologies for controlled synthesis and characterization.

**(i) Improving the current theoretical description of solids and superconductivity:** inherent limits connected to widely used approximations in solid state theory prevent an accurate description of many of the most promising classes of high- $T_c$  superconductors. Electronic and nuclear excitations in hydrogen-rich solids may only be described including non-adiabatic and anharmonic effects beyond the standard Born–Oppenheimer approximation. Most unconventional superconductors exhibit strong correlation effects (Mott transitions, localized magnetism, etc) beyond the reach of

standard mean-field density functional theory (DFT). Moreover, exploring pairing mechanisms other than that based on the electron–phonon interaction, such as plasmons, excitons, paramagnons, requires extending current first-principles theory of the superconducting phase.

**(ii) Extending the domain of methods for computational material design:** *ab-initio* crystal structure prediction (CSP) methods have been the major driving force behind the *hydride rush* that led to the discovery of room temperature superconductivity, and it is thus natural to consider them the most promising tool to discover new high-temperature superconductors.

However, many of the scientists contributing to this roadmap point out that a paradigm shift will be needed to explore the phase diagrams of more complex materials than simple binary hydrides, such as  $\text{SH}_3$  and  $\text{LaH}_{10}$ . A major role will be played by artificial intelligence (AI) and machine learning (ML) methods, applied to different aspects of superconductor design. For example, new machine-learning force fields, delivering accurate total energy and forces at reduced computational cost, can be employed to explore the potential energy landscapes of more complex materials, and give access to processes involving much larger time and length scales, such as pressure–temperature phase diagrams, defect structures, non-equilibrium phases, grain-boundaries, and alloys.

ML also represents a formidable tool to identify *a priori* promising regions of the chemical space through high-throughput screening. This will require identifying efficient superconductivity *descriptors* to replace the empirical principles used in the past. The high-throughput approach is completely independent of the specific chemical composition or superconducting mechanism.

**(iii) Developing new experimental methodologies for controlled synthesis and characterization:** the main scientific objective of future superconductor research, as clearly stated by all contributors to the collection, is to reduce the pressure range in which RTSC is found. Different experimental strategies are proposed, ranging from the increase of energy barriers between metastable and stable phases, to the exploration of the P–T phase diagrams, to the use of appropriate substrates and synthesis techniques, and even AI to guide the experiments and the synthesis.

The contributions to the roadmap have been divided into six sections, which cover different aspects of the prediction of A-SC. In the introduction, **Warren Pickett** provides a historical overview on theoretical predictions of superconductivity, and offers a critical discussion of the key quantities that need to be optimized to achieve room critical temperatures in conventional superconductors. In section 2 (hydrogen-rich solids) and section 3 (CSP methods) we have collected contributions from several groups who have played a major role in the synthesis and prediction of superhydrides.

The first part features contributions from the authors of the three main experimental discoveries in the field: **Mikhail Erements**, who was the first to observe high  $T_c$  superconductivity in  $\text{SH}_3$ , **Russell Hemley**, who measured superconductivity at 260 K in lanthanum hydride ( $\text{LaH}_{10}$ ), and **Ranga Dias**, who has recently reported room temperature superconductivity in

a carbon sulfur hydrogen compound. **Christoph Heil** reviews the peculiar bonding properties and pairing of several hydrides.

Neil Ashcroft's 1968 prediction that atomic hydrogen would be the ultimate conventional superconductor has been one of the main driving forces of high pressure research leading to superhydride discovery. **Carlo Pierleoni** reviews the current understanding of this exciting field, which has seen many developments in the last five years.

**Maximilian Amsler, Nikita Rybin and Collaborators, Hanyu Liu and Yanming Ma and Chris Pickard** review and discuss future challenges of material design methods, and strategies to overcome the obstacle represented by the growing complexity of the search space. In this respect **Eva Zurek** and **Tiange Bi** discuss the role of chemical experience in automated structural search, while **Aleksey Kolmogorov** presents an interesting combination of material design and ML.

Section 4 provides a critical analysis of the most recent developments, limitations and perspectives in the field of *ab-initio* superconductivity. Besides the excitement caused by their discovery, high- $T_c$  superconducting hydrides have proven a marvelous test-bed for our current theories of conventional superconductivity. These materials combine large critical temperatures and complex lattice dynamics, challenging the capabilities of cutting-edge methods in electronic structure theory and *ab-initio* superconductivity.

**Ion Errea** discusses the complexity of the quantum nature of the energy landscape of these strongly anharmonic systems, which goes well beyond the limits of the conventional Born–Oppenheimer adiabatic picture. **Ryotaro Arita** presents a completely parameter-free formulation of Eliashberg theory and demonstrates its exceptional precision in capturing the superconducting properties of lanthanum hydrides, tracing a path of future developments to address room temperature superconductivity and non-phononic mediators. **Roxana Margine** also shares her view on the future of the *ab-initio* Eliashberg approach, addressing important points such as the use of Wannier functions to accurately describe momentum anisotropy, the role of vertex corrections, and recent results on a perturbation theory approach based on GW rather than DFT. **Camilla Pellegrini** and collaborators review recent developments in DFT for superconductors, and discusses the possibility of combining this theory with the exact-factorization framework for the efficient treatment of non-adiabatic effects.

The importance of AI methods for material discovery is bound to increase in the coming decades. The potential of AI, and in particular of ML, applied to superconductivity is reviewed and discussed in section 5 in two contributions by **Valentin Stanev** and **Stephen Xie** and collaborators as coauthors.

This collection is concluded by section 6 (other superconductors), which includes two contributions that directly address the zero-pressure limit. **Renato Gonnelli** and collaborators discuss the application of protonization to hydrogenate conventional materials and mimic, at normal conditions, the physical properties of high-pressure hydrides. **Roser Valenti** provides a concise but complete review of the problem of predicting unconventional superconductors, focusing on the specific limitations of current computational methods.

Finally, in the appendix, we have collected the answers of the authors to several questions that provide a more informal view on the present and future of the field.

We wish to thank all authors for their inspiring contributions and their willingness to share personal views and indications to promising research directions.

The editors:

Lilia Boeri, Richard Hennig, Peter Hirschfeld, Gianni Profeta, Antonio Sanna, Eva Zurek

## 1. Introduction

## 2. Historical perspectives on the RTS roadmap

*Warren E Pickett*

University of California Davis, United States of America

### 2.1. Status: decades of chagrin; recent elation

The paradigm-resetting breakthrough (2014–2019) to RTS in metal hydrides at very high pressure will be covered elsewhere in this roadmap, and mentioned below. The studied pressures of 100–500 GPa are comparable to those in the Earth's mantle, up to 140 GPa, and the Earth's center (360–400 GPa). Jupiter, comprised of H and He and sometimes speculated to be superconducting, has an unclear pressure profile but temperatures up to  $10^4$  K. Such geologically high pressures and the tiny samples needed to study them in the lab unfortunately rule out applications of their fascinating superconducting properties. Nevertheless the progress has been stunning.

The formal theoretical attack on prospects for higher electron–phonon  $T_c$  was initiated in 1973 by Bergman and Rainer [1] building on the pioneering work of McMillan, when they calculated the change in  $T_c$  due to a positive incremental change in the Eliashberg spectral function  $\alpha^2F(\omega)$ , i.e.  $\delta T_c / \delta \alpha^2F(\omega)$ . A broad maximum around  $\omega_{\max} \sim 2\pi kT_c$ , ( $\hbar = 1$  units) provided a preferred frequency range for adding coupling. Within rigorous Eliashberg theory, Allen and Dynes (1975) [2] established that in the large  $\lambda$  regime ( $\lambda > 10$ , say),  $T_c \rightarrow 0.15\Omega\lambda^{1/2}$ . Specifically:  *$T_c$  is unbounded within Eliashberg theory.* Here  $\Omega$  is a well-defined characteristic phonon frequency, viz the 2nd moment of  $\alpha^2F(\omega)/\omega$ . Unfortunately, for five decades ‘large  $\lambda$ ’ in actual superconductors has hovered near  $\lambda \sim 2$ —typically referred to as strong coupling but not close to the large  $\lambda$  regime as mentioned above.

The interpretation of the  $T_c$ – $\lambda$ – $\Omega$  interconnection has long been considered within (1) the elemental coupling strength expression of McMillan, that  $\lambda = N(0)I^2/M\Omega^2$  together with (2) the Allen–Dynes (AD) expression  $T_c^{\text{AD}}(\lambda, \Omega)$  fit to much data and many models of  $\alpha^2F(\omega)$ .  $N(0)$  reflects the number of electrons involved in pairing,  $M$  is the nuclear mass, and the squared matrix element  $I^2$  is discussed below. Unfortunately, nature rarely provides an opportunity for a simple, safe, incremental, and optimal increase in  $\alpha^2F(\omega)$  a la Bergmann–Rainer. Most often, attempts by analogy followed by design have resulted in unstable materials, viz the predictions: rocksalt NbN (16 K)  $\rightarrow$  MoN (30 K) (*Nature* 1982); MgB<sub>2</sub> (39 K)  $\rightarrow$

$\text{Li}_x\text{BC}$  (70 K) (*Phys. Rev. Lett.* 2002). Neither predicted compound,  $\text{MoN}$  nor  $\text{Li}_x\text{BC}$ , could be stabilized in the desired structure. Almost without fail, trying to increase  $\lambda$  of a good superconductor has resulted in adding coupling at, or driven to, low frequency  $\omega \ll \omega_{\text{max}}$  and modest increase of  $T_c$ , but more prominently approach to lattice instability.

Some analysis has encouraged the design of RTS. In quasi-two dimensions (2D) the contribution to coupling from each cylindrical Fermi surface (FS) provides additional coupling independent of FS volume, due to phase space considerations (think of  $\text{MgB}_2$ ,  $T_c = 40$  K with the right B isotope). Adding more FSs will lead to ever increasing coupling strength  $\lambda$ , [3, 4] which may enhance coupling to difference branches and wavevectors of phonons, thereby avoiding unstable modes. A cursory survey (by the current author) indicated that it is not easy to find band structures that lead to additional bands crossing the Fermi level, while keeping strong coupling. This approach does however contribute to the roadmap to stronger coupling in 2D materials.

Jumping ahead to the current decade, design [5] and discovery [6] in 2014–2015 of hydrides that superconduct at 200–260 K at megabar pressures have begun to provide insight. The vast difference in mass of the metal atom and hydrogen allow their contributions to  $T_c$  (through  $\alpha^2F$ ) to be separated, enabling designers to ‘turn off’ computationally the metal atom contribution. The result was that the low frequency metal atom contribution to coupling *should be neglected* to obtain an understanding of  $T_c$  [7]. The metal atom’s coupling increases  $\lambda$  but, lying at low frequency it decreases the phonon moment  $\Omega$ . The net effect on  $T_c$  is minor; it can even be negative, even though ‘coupling strength’  $\lambda$  is increased by  $\sim 10\%$ . The contribution from H atoms alone should be considered to understand  $T_c$ , and thereby how to design higher  $T_c$ . Already in 1974, Leavens and Carbotte [8] had shown that for the known superconductors of the time, a very good relationship is  $T_c = 0.15\lambda\Omega$ ; the right-hand side is proportional to the zeroth frequency moment of  $\alpha^2F(\omega)$ , i.e. the area under  $\alpha^2F(\omega)$ , whereas  $\lambda$  is the 1st inverse moment. Notably, Quan *et al* [7] found that this expression works equally well for the high pressure hydrides, if the metal atom contribution is neglected.

In the last decade design of (possible or now real) RTSs has focused on highly compressed metal hydrides, which provides atomic-like H in a lattice and thereby might approximate the metallic hydrogen acme of superconducting  $T_c$  [9]. Design of H-rich metal hydrides at 100–400 GPa pressure has provided a challenging palette to be painted by designers, but much has been accomplished. Cui’s group provided [5] the patently outrageous prediction of  $T_c = 200$  K around 160–200 GPa for  $\text{H}_3\text{S}$  in one of the simplest possible structures (bcc, 1 f.u./cell). In less than a year Erements’ group (proceeding independently) synthesized [6] their H–S sample showing  $T_c = 200$  K at 160 GPa, subsequently identified as  $\text{H}_3\text{S}$ —remarkable agreement. This eminently successful prediction involved little in the way of informed design; nothing was known (and still is not) about how to design an RTS hydride, beyond the current mantra of ‘include a lot of hydrogen with high frequencies and hope for strong coupling’.

## 2.2. Current and future challenges: a revisionist approach to RTS

The first level challenge is to obtain an understanding in terms of current (or new) properties that will enable rational design: what should one pursue, and why? A guideline is given in the previous section:  $\lambda = N(0)I^2/M\Omega^2 = \eta/\kappa$ . Philip Allen gave important insight into this expression: the denominator is obviously the lattice stiffness  $\kappa$  (harmonic oscillator force constant, and independent of mass), thus the numerator represents an electronic stiffness  $\eta$  (the McMillan–Hopfield parameter). Obviously, large  $N(0)$  gives the electronic system a large response (and tendency toward instability). The role of  $I^2$  in electronic stiffness against lattice motion is evident in principle but an enigma in practice. As for increasing the coupling: (1) increasing  $N(0)$  always helps, until it leads to lattice, magnetic, or thermodynamic instability. Electronic structure studies provide data and sometimes intuition on how a class of metals might be manipulated to increase  $N(0)$ . (2) Much is understood about  $\Omega$ —which frequencies should be high or low, what bonds are likely to be stiff, etc—although first principles calculations must always be carried through. (3) The FS averaged squared matrix element  $I^2$  is the elephant in the room, or more realistically, the chimera in the closet. To say that nothing is understood about what makes  $I$  large or small is almost an understatement. In the Gaspari–Gyorffy model [10] of rigidly displaced atomic potentials, a simple expression was obtained but involved scattering phase shifts at the Fermi level, for which modest understanding is available (although it did provide a means for theoretical engineering of increases in  $T_c$ ).

Although not mentioned yet, there is the crucial underlying necessity for materials designers: to determine if the designer materials can be synthesized, viz if they are thermodynamically and dynamically stable. In the words of a materials growth experimentalist to designers: ‘do not pollute the literature with stuff that cannot be made’. This is a tough challenge: (i) calculate whether your designed material is dynamically stable (all positive phonon frequencies), and (ii) the hard part: determine whether competing phase(s) will make the materials impossible to synthesize. Algorithms have been developed to help the designer to chase and test the most likely competing phases and several groups are applying them.

## 2.3. Advances to meet challenges: recognize the tyranny of $\lambda$

In retrospect, too much emphasis has been placed on  $\lambda$ , and its deceptively simple decomposition into  $\eta$  and  $\kappa$ . However, from 1970 to 2020, ‘strong coupling  $\lambda$ ’ has been not far from 2, while  $T_c$  has increased from 23 K to 260 K. The following are a sampling of the largest  $\lambda$  superconductors over time (hydride numbers have some uncertainty):

1975: Pb–Bialloys:	$\lambda \sim 2.1\text{--}2.6$	$\Omega \sim 4$ meV	$T_c \sim 7\text{--}8$ K [2]
2014: $\text{H}_3\text{S}$ :	$\lambda \sim 2$	$\Omega \sim 150$ meV	$T_c = 200$ K
2019: $\text{LaH}_{10}$ :	$\lambda \sim 2$	$\Omega \sim 175$ meV	$T_c = 260$ K [7, 11].

A factor of 35–40 increase in  $\Omega$  has produced a factor of 30 increase of  $T_c$ , in spite of impotence displayed by  $\lambda$ . It is

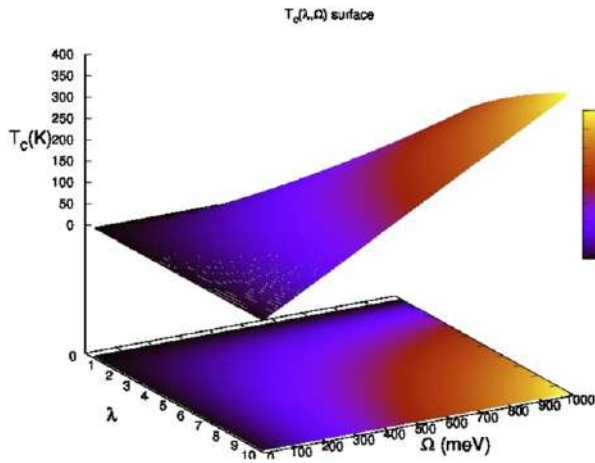

**Figure 1.** Surface plot and projected heat map of AD’ expression  $T_c^{AD}(\lambda, \Omega)$  (origin is at far left) emphasizing the very large range of the arguments. The plot is roughly symmetric, with the maximum lying along ‘diagonal’ with a decrease toward either axis. The implication is that both  $\lambda$  and  $\Omega$  must be large for high  $T_c$ , which is challenging because  $\lambda$  is proportional to  $\Omega^{-2}$ . The scale of  $T_c$  is normalized to the value of H<sub>3</sub>S at the calculated values of  $\lambda$  and  $\Omega$  for  $T_c = 200$  K.

$\eta = \lambda M \Omega^2$  that has ballooned, by an order of magnitude, mirroring the increase in  $M \Omega^2$ .

As noted above, designing to increase  $\lambda$  has led to unstable lattices. This observation suggests that the focus should shift to a more direct functional dependence such as  $T_c^P(\eta, \kappa)$  rather than

$$T_c^{AD}(\lambda = \eta/\kappa, \Omega = [\kappa/M]^{1/2}) \sim \Omega f(\lambda = \eta/M\Omega^2) = (\eta/M\lambda)^{1/2} f(\lambda),$$

which is effectively a prefactor  $\Omega$  modulated by a function  $f(\lambda)$ . There is, in  $T_c^P(\eta, \kappa)$ , still a dependence of  $\kappa$  on  $\eta$  but it is an independent functional relationship; most previous analysis has considered the functional dependence of  $\kappa$  on  $\lambda$ , which itself depends on  $\kappa$ , leading to a circular functional dependence that, notwithstanding conceptual importance for lattice instability, misguides analysis of enhancing  $T_c$ . Figures 1 and 2 provide surface plots of these  $T_c$  functions, see the captions for explanation.

One can observe: increasing  $\Omega$  with other parameters fixed decreases  $\lambda$ —the adversarial connection in the effect on  $T_c$ . A very common effect is: increasing  $\lambda$  enhances renormalization downward of  $\Omega$ , with feedback (further increased  $\lambda$ ) that drives the lattice toward instability. This circular enigma has been studied for five decades, but most often reduces to details not evident in the broad materials properties that are being discussed. Rather, one specific branch in a small range of wavevector is driven soft while the silent majority (95%–99%), and  $\Omega$ , have not changed much. Hence, average properties— $\lambda$ ,  $\Omega$ ,  $\eta$ ,  $\kappa$ —miss the crucial physics of lattice (in)stability, which is highly material specific (FS specific, bonding specific, etc).

The AD strong coupling limit,  $T_c \rightarrow 0.15 (\eta/M)^{1/2}$ , removes  $\kappa$  as a critical player in beyond-RTS considerations, hence eliminating  $\lambda$  as well, aside from retaining lattice stability. The

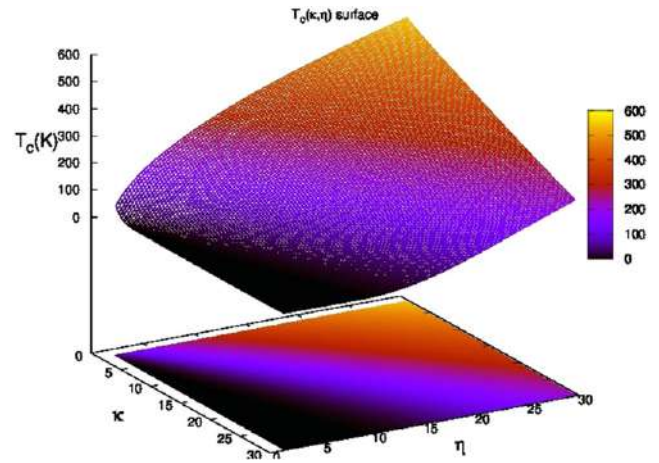

**Figure 2.** Plot as in figure 1 of  $T_c(\kappa, \eta)$  taken from the AD equation (origin is at far left) emphasizing very large values of the arguments. As in figure 1  $T_c$  is normalized to values for H<sub>3</sub>S ( $T_c = 200$  K). The large values of  $T_c$  lie along the  $\eta = N(0)I^2$  axis; the lattice stiffness  $\kappa = M\Omega^2$  is of somewhat secondary importance, but of course important for stability of the lattice.

Leavens–Carbotte form, parametrizing good superconductors of the time and for hydrides as well [7, 8], differs by a  $\lambda^{1/2}$  factor so it does still implicate some importance for  $\lambda$  for advances in 1970s, and 2020s, superconductors.

These guidelines return the focus to the (still enigmatic) FS averaged electron–ion matrix elements  $I^2$ , which involve only the static lattice and its electronic linear response (no phonon information). The goal then is to keep the lattice stable and better yet stiff, but otherwise innocuous while increasing the electronic stiffness  $\eta = N(0)I^2$ . Beyond the Gaspari–Gyorffy model, there has been little progress on understanding  $I^2$ . There are clear avenues for progress: since these are simply matrix elements of the change in potential due to an infinitesimal displacement, these are quantities already coded (in some form) into existing Eliashberg codes. Elements, and hydrides (essentially elemental hydrogen for these purposes [7]), will provide very clear information on how  $I^2$  depends on atom, environment, and FS character.

Materials design is heavily *in silico* technology. Whereas progress has been made in optimizing the computational ‘Eliashberg machine’ [12] and crystal structure discovery [13], computational expense of materials design remains a substantial challenge as the search proceeds from binaries to ternaries (the essential element being H, but the possibilities being expanded enormously). Machine learning (ML) algorithms are beginning to be applied. At the current stage, these efforts ignore detailed quantum mechanics while relying on materials data and statistics in the expectation of thereby identifying unforeseen patterns. Extension to the yellow brick road toward RTSs provides an extra challenge, given the dearth of data on near-RTS materials.

#### 2.4. Concluding remarks: the known unknown

A reassessment of the historical progression of high  $T_c$  based on the conventional mechanism indicates that focus on the dimensionless measure  $\lambda$  of coupling has been unfruitful and



misleading, leading to the roadblock of lattice instability. High  $T_c$  instead is linked to larger  $\eta = N(0)I^2$ , and  $I^2$  is available in codes but has not been isolated for study. That should be the objective, but it is not that easy.  $I^2$  involves a *screened* atomic displacement, and screening is linked to  $N(0)$ ; understanding thus requires that the product  $N(0)I^2$  requires investigation *in toto* [12, 14], with attention to the character of Fermi level wavefunctions.

A last factor to mention is that of the (neglected above) effective electron–electron repulsion  $\mu^*$ , renormalized downward by the frequency mismatch between nuclear and electron velocities. An illustrative expression for the reduction compared to the instantaneous repulsion  $\mu$  is  $\mu^* = \mu/(1 + \mu \log[\omega_{pl}/\Omega])$ , where  $\omega_{pl}$  is the electronic plasma frequency. The point is that increasing  $\Omega$ , and thereby  $T_c$  as discussed above, has the negative effect of increasing the effective Coulomb repulsion and thereby opposing higher  $T_c$ . This is likely a minor effect (due to the logarithmic dependence) but illustrates the need to address the issues collectively.

The formal and computational means for progress is in hand. What may be most lacking is recognition that *understanding* of electron–phonon coupling that is needed to guide the roadmap is *not* yet in hand. Note: this discussion has followed the McMillan–Hopfield decomposition of  $\lambda$  that strictly applies only to elements; compounds may provide additional mechanisms for enhancing  $T_c$ .

## Acknowledgments

Yundi Quan has provided many useful discussions on this topic, and assistance with preparation of the figures in this paper. Giustino's review [12] contains a wealth of references on this topic. This work was supported by US National Science Foundation Grant DMR 1607139.

## II. Hydrogen-rich solids

### 3. Fabrication and stabilization of superconducting superhydrides

Ranga Dias

University of Rochester, United States of America

#### 3.1. Status

One of the grand challenges in condensed matter physics is the quest for room-temperature (RT) superconductivity. More than a century of rigorous research had led physicists to believe that the highest critical temperature ( $T_c$ ) that could be achieved for conventional superconductors was 40 K [15]. However, the recent discovery of superconductivity in hydrogen sulfide at 203 K changed the notion of what might be possible for phonon-mediated superconductors [6]. This paradigm shift in our understanding of superconductivity has centered around the role of hydrogen (figure 3). Theorists have shown that metallic hydrogen should have the high Debye temperature and strong electron–phonon coupling necessary for high- $T_c$

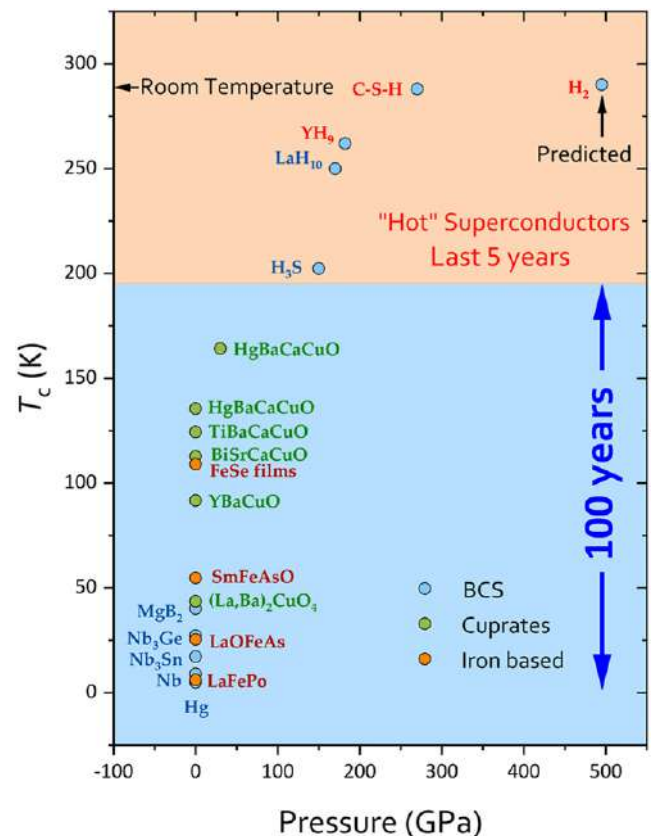

**Figure 3.** Superconducting  $T_c$  plotted against pressure. High pressure techniques create the prospects for identifying RTSC. Three red labels demonstrate the preservation of the high  $T_c$  superconductivity while lowering the pressure (red arrow).

phonon-mediated superconductivity. However, extreme pressure would be required. As an alternative, this elusive phase of hydrogen can be mimicked by using hydrogen-rich materials [16]. In such materials, hydrogen is already in a chemically pre-compressed phase and once impelled by further external pressure, can be metallized at much lower pressures than pure hydrogen, providing the necessary conditions for promoting high- $T_c$  superconductivity at more feasible pressures. Not surprisingly, this is a very active Frontier for research, which is evolving rapidly though advances in *ab initio* simulations [17] and tremendous recent progress in experimental observations. The first of its kind was discovered on  $\text{LaH}_{10}$  ( $T_c \sim 250$  K to 260 K) and recently  $\text{YH}_9$  ( $T_c \sim 243$  K to 262 K) was discovered [10, 18, 19]. However, thus far, theoretical and experimental studies are mainly focused on binary superhydrides. Going forward, more compounds are possible by expanding to ternaries, although the predictions are harder because of the increased number of structural configurations to consider and the number of ways that a candidate structure can decompose is much greater. Therefore, relatively little is known about the phase stability and configurational energy landscape of ternaries. A recent experimental study has reported RT superconductivity in carbonaceous sulfur hydride system with the highest  $T_c$  of 288 K at 267 GPa [20]. Searching for RT or above RT superconductors among the ternary or quaternary superhydrides is a natural and very timely extension to the rapidly

developing field of high- $T_c$  superconductivity to harness those properties at much lower pressures or ambient pressures for transformative technologies.

### 3.2. Current and future challenges

Pressure is a particularly important parameter for driving reactions toward higher metal oxidation states that cannot be accessed through other synthesis routes. Furthermore, a vital component of driving materials to higher densities is the ability to push insulating materials into a metallic state. This is critical when searching for superconducting states, as best demonstrated by  $H_2S$  [6]. Often, the formation of compounds under pressure is hindered by a strong kinetic barrier, as encountered in the synthesis of highly refractory carbides [21]. However, this often does not apply to hydrogen due to its extremely high reactivity and diffusivity, especially under high pressure–temperature conditions. Although this has been a major hindrance in the quest for metallic hydrogen at extreme conditions, due to detrimental reactivity with the sample environment, this could play a positive role in achieving novel reactivity with metals for new hydrogen-rich material synthesis. Therefore, the necessity for controlled tunability of pressure and temperature (i.e., the energy density) is critical in the search for new materials. This interplay between pressure and temperature provides a powerful tool—giving access to novel states, allowing control of reaction pathways, and directly examining kinetic factors.

Accurate structure determination in superhydrides, hindrance by significant challenges in determining the location of hydrogen by x-ray diffraction (XRD), which has been the common approach for structure determination to date. Difficulties in probing lighter elements arise in XRD because the scattering power of an atom scales as  $Z^2$ . This causes heavier nuclei to dominate the signal, especially in relevant examples such as the rare-earth metal (Y, La) superhydrides. Consequently, any reliable information is lacking regarding the location of the protons, with further complications in materials like C–S–H where the overall scattering power of the sample is weak and the sample single crystal-like. To overcome such limitations, it is vital to develop an alternative characterization suite of x-ray spectroscopy tools that inform on the local electronic structure and coordination environment of a targeted element.

### 3.3. Advances in science and technology to meet challenges

The high-pressure techniques are becoming indispensable to obtain new materials with unusual properties. These techniques can complement more conventional synthesis approaches to discover new materials. It is important to develop methods that can be used to quench the materials to low or ambient pressures. This can be achieved by increasing the kinetic barriers toward decomposition and/or inducing chemical pressure. The latter can be created when an atom or ion is located at a crystalline site that is smaller than the atomic or ionic radius. The chemical substitutions to enhance superconductivity suggest suitable substrates for the epitaxial

growth of super-hydrides to reduce the applied external pressure. Developments in substrate could be used to reduce the required high pressure by growing the clathrate super-hydride on a suitable but an inert surface structure with lattice parameters slightly less than that of the clathrate itself to generate chemical pressure. In order to synthesize these superhydrides, we have used a diamond anvil cell (DAC), which includes two diamond anvils. It is quite natural to think of a way to use diamond as an inert substrate. It is possible to design MBE methods to grow superhydrides superconductors at ambient pressures and formulate strategies for quantum device design, including ambient and high-pressure environments.

Accurate structure determination of hydrogen-rich materials under very high pressure is extremely challenging and that the structural and stoichiometric determination of super-hydride systems have been clouded by a reliance on XRD techniques. To overcome such limitations, it is vital to develop an alternative characterization suite of x-ray spectroscopy tools that inform on the local electronic structure and coordination environment of a targeted element. Techniques like x-ray absorption spectroscopy, that probe the scattering from nearby atoms of x-ray induced photoelectrons, and x-ray emission spectroscopy, that provides an element specific partial occupied density of states, allow for a more complete structural picture of these hydrogen-rich materials than afforded by XRD alone. These types of measurements in the megabar regime are currently extremely challenging but will provide new light in directly probing elements like carbon and sulfur.

### 3.4. Concluding remarks

The search, synthesis, and structural and physical characterization of superhydrides with high superconducting transition temperature, and an understanding of how to access metastable pathways to their recovery to ambient conditions is critical for the advancement of material science and energy transmission technology [22]. Modern exploratory syntheses require extensive assistance from a wide range of computational tools at every step. CSP searches are ideally suited to identify which compounds are sufficiently stable that they might be synthesized. By comparing free energies across pressure ranges for competing phases computationally, we can target very specific experimental conditions where target compounds are likely to form. Many experimentally measurable properties can be simulated to high precision and made available during synthesis (figure 4). While traditional trial-and-error approaches to synthesis often require weeks or months to assemble enough experimental data to identify a new phase. As simulation and experiment improve our understanding of the kinetic and thermodynamic aspects of stability, a detailed understanding of adjusting structure and composition may be exploited to rationally design and stabilization of high  $T_c$  superconducting superhydrides at ambient conditions.

### Acknowledgments

We acknowledge Ashkan Salamat, Elliot Snider, Nathan Dasenbrock-Gammon, Raymond McBride, Mathew Debessai

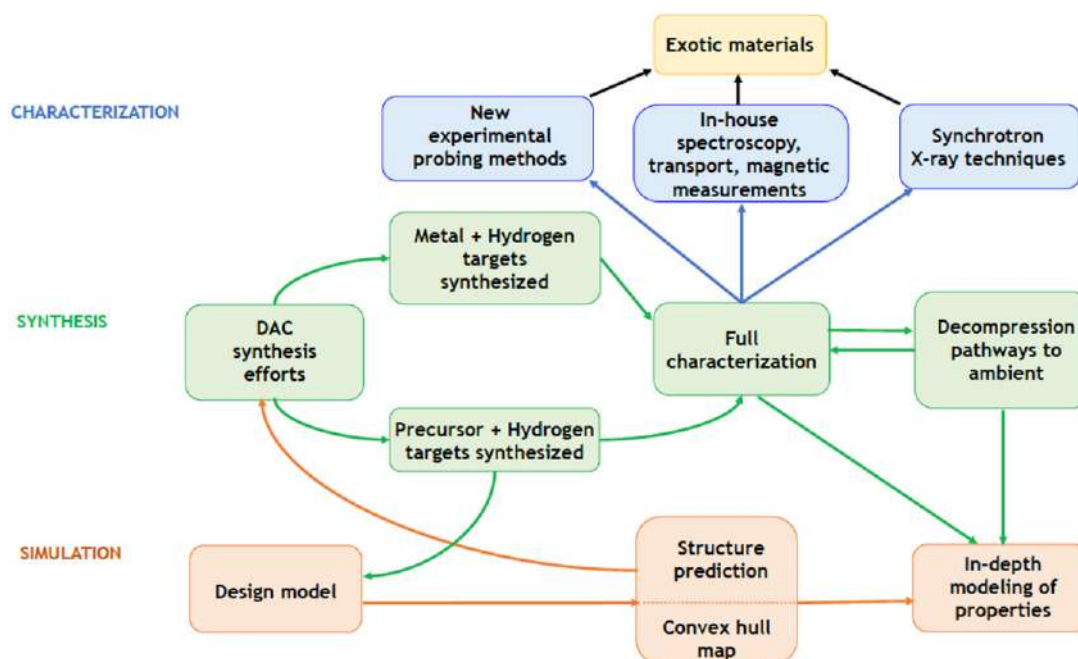

Figure 4. The workflow of the synthesis and stabilization of materials by design.

for useful discussions. This was supported by NSF, Grant No. DMR-1809649, and by the DOE Stockpile Stewardship Academic Alliance Program, Grant No. DE-NA0003898.

#### 4. High temperature superconductivity in hydrides

Mikhail I Eremets

Max Planck Institute for Chemistry, Germany

##### 4.1. Brief history and status

A dream of the RTSC always motivated the field of superconductivity. However, an empirical search revealed only very low-temperature superconductors with the highest transition temperature  $T_c = 28$  K (figure 5). The great BCS theory explained the superconductivity, and this understanding led to an increase of  $T_c$  but only to the modest value of 39 K in  $\text{MgB}_2$ . The prevailing opinion was formed that the conventional phonon-mediated pairing of electrons could not provide high  $T_c$ . The real hope for RTSC gave a discovery of cuprates, unconventional superconductors that operate at a temperature above liquid nitrogen. However, after thirty-five years of tremendously intense efforts, a microscopic theory of the high- $T_c$  superconductors still is not established that hampers further progress in the transition temperature.

Unexpectedly, conventional superconductivity opened a straightway to RTSC. In 2015, ‘Earth temperature’ superconductivity at 203 K discovered in  $\text{H}_3\text{S}$  [23], later, in  $\text{LaH}_{10}$  at 250 K [18], (260 K was claimed in reference [24]). Recently superconductivity at 287 K in  $\text{H}_3\text{S}$  modified with carbon was announced [20] but more experiments are need to prove it.

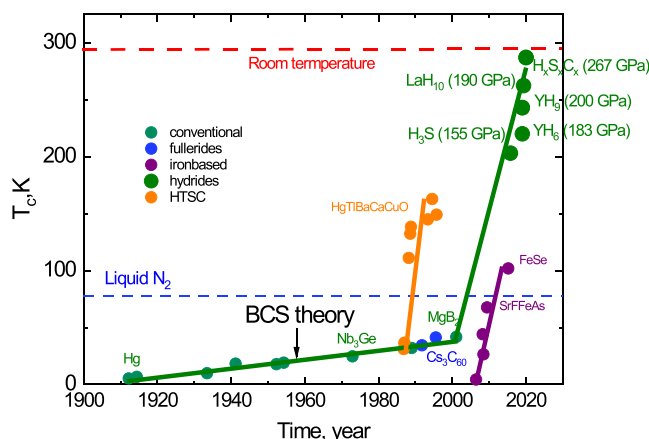

Figure 5. The evolution of the superconductivity transition temperature for representative materials.

This incredible progress resulted from the symbiosis of experiment with theory [16] and the greatly developed computations. The superhydrides are perspective for further increase of  $T_c$  and search for the ultimate limit of the transition temperature—agenda changes to ‘hot’ superconductivity. Already superconductivity with  $T_c = 200^\circ\text{C}$  was predicted for a ternary  $\text{MgLiH}$  [25].

Further advances will be likely connected with finding conventional superconductors at ambient pressures. The experience accumulated for the hydrides will be used for the search.

##### 4.2. Big research issues and challenges

High-pressure hydrides remains to be an excellent platform for the search of the ultimate limit of the conventional superconductivity.  $T_c \sim 400\text{--}500$  K would require for future applications of superconductivity at room temperature.

An obvious next big goal is conventional superconductors at ambient pressure above the temperature of liquid nitrogen needed for applications. Several authors discussed this possibility, particularly Cohen [26]. How the high-pressure studies of superhydrides relate to this goal?  $\text{H}_3\text{S}$  gives a good example that covalent metals (such as  $\text{MgB}_2$  at ambient pressure) can be HTSCs at right combination of parameters such as high Debye frequencies, electron–phonon coupling, and the density of states at the Fermi level. Instead of hydrides, carbon-materials or other with light elements can be perspective for ambient pressure [27]. Carbon atom is relatively light, and what is the most important, that many carbon materials have strong covalent bonding that leads to high phonon frequencies—very comparable with  $\text{H}_3\text{S}$  which has  $T_{\Theta} \sim 1500$  K [28]. Diamond, nanotubes, fullerenes etc intrinsically are insulators, semiconductors, or semimetals but they can be turned to metallic and superconducting state by doping or alloying [27] in comparison with hydrides which metalize with application of pressure. Another obvious lesson from the high-pressure studies is the importance of hydrogen in the system: calculations showed that an addition of hydrogen to carbon materials can significantly enhance  $T_c$  [29]. Several calculations predicted different compound of light elements which are superconductors with  $T_c > 100$  K. There is significant progress in the experiment too: superconductivity  $T_c = 55$  K was announced in amorphous carbon heavily doped with boron. However, experimental finding superconductivity with  $T_c > 100$  K seems to be a big challenge.

#### 4.3. Advances in science and technology to meet challenges

Further progress toward ‘hot’ superconductivity most likely connected with ternary hydrides. Both experimental and theoretical search superconductivity in these compounds are difficult. The calculations should be developed to at the level of efficiency of prediction of superconductivity in binary compound and provide experiment with a guide of candidate structures, and the experiment will provide a feedback. Intuitive and empirical search will continue, but even being providing with good predictions, experimental high-pressure studies remain to be complicated and slow while gradually becoming more efficient. An apparent difficulty is the synthesis. The ratio of elements in the samples either in the stoichiometric or doped compound is difficult to control. An analysis of the synthesized samples should be developed. At present, it is limited with x-ray, Raman spectroscopy and the electrical measurements.

Search for ambient pressure superconductivity is difficult in a high pressure laboratory unless superconductors will be found which can be recovered to ambient pressure. The pressure of the synthesis should be low, few GPa, for workable applications.

Most likely the search will be done in carbon-, boron- or other light element based materials. This search requires different technology for synthesis, doping and analysis of the material that can be done in a well-equipped material science laboratory. Still, some projects are workable by using the accumulated experience with the high pressure hydrides.

For instance, hydrogenation of the samples can be done in the confined volume of DAC

#### 4.4. Concluding remarks

The discovery of near room temperature superconductivity with  $T_c = 203$  K in hydrogen sulphide triggered amazingly quick and extensive development of the high-temperature conventional superconductivity both theoretically and experimentally. The superconductivity was confirmed and well established in different laboratories. The theory, the first principle calculations continue to fuel the field and bring many candidates for high-temperature superconductors realised in a new record in  $\text{LaH}_{10}$ :  $T_c = 250$  K (260 K in reference [24]). A search resulted in nearly RTSC at 287 K in hydrogen sulfide changed by carbon: either by doping or forming an HSC ternary compound, however, this announced result still after three months, is not confirmed. Even higher, ‘hot’ superconductivity is probable in view of the predictions, in particular calculations of 200 °C superconductivity in  $\text{MgLiH}$  ternary.

The experience accumulated in the studies of the high-pressure hydrides already is using for calculations of at ambient pressure and hopefully will follow with experimental discoveries of new superconductors.

### 5. Bonding and electron–phonon coupling in high-pressure hydrides

*Christoph Heil*

Graz University of Technology, Austria

#### 5.1. Status

The experimental realization of superconductivity (SC) at about 15 degrees Celsius in carbonaceous sulfur hydride by Snider *et al* [30] in 2020 represents the most recent milestone in a long list of achievements in the hunt for room-temperature SC that started a bit more than a century ago with the discovery of SC below 4 K in mercury [31, 32]. The latest progresses in computationally describing materials’ properties enable researchers to theoretically predict crystal structures completely in silico and to calculate their critical superconducting temperatures, abilities that have proven to be invaluable tools in the search and screening for highest- $T_c$  materials. Only 5 years after the first reports of near room-temperature SC in  $\text{SH}_3$  [33], the scientific community has already determined the high-pressure phase diagrams of most binary hydrides [31, 32]. Within these, two classes of high- $T_c$  materials have been identified: (i) covalent hydrides and (ii) hydrogen-rich sodalite-like clathrate (SLC) structures. In the former case of covalent hydrides, such as  $\text{SH}_3$ , H and the other element create a network of strong covalent bonds that become metallic due to the extreme pressures. For these, the degree of covalency determines to a large part the value of  $T_c$ , and neither too weak nor too strong bonds are preferable [34]. In the latter case, SLC hydrides are highly symmetric, forming hydrogen cages around a guest atom. While the situation is not as clear here and further research efforts need to be invested,

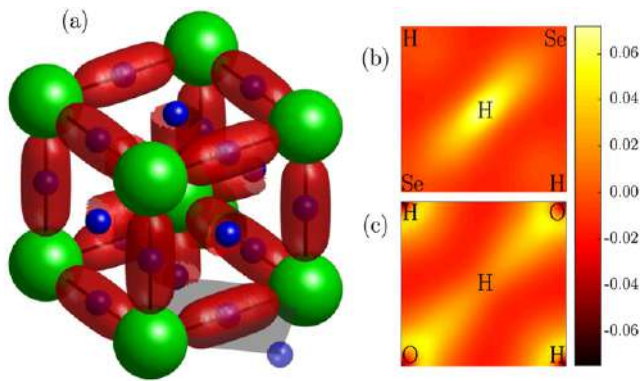

**Figure 6.** (a) Crystal structure and isocharge surface ( $\rho = 0.01$ ) of  $\text{SeH}_3$  in the conventional unit cell. (b) Charge plot in the gray-shaded plane of (a) for  $\text{SeH}_3$  and (c) for  $\text{OH}_3$ , both with subtracted backgrounds. In the case of  $\text{SeH}_3$ , most of the charge is located around the H atoms, while for  $\text{OH}_3$  most of the charge is in the vicinity of O. Both scenarios are suboptimal with respect to achieving the highest  $T_c$ . Reprinted figure with permission from [34], Copyright (2015) by the American Physical Society.

it became apparent that their geometry plays an important factor with respect to bonding, electron–phonon (ep) coupling, and their superconducting properties [35]. Within this class,  $\text{LaH}_{10}$ ,  $\text{YH}_6$ , and  $\text{YH}_{10}$  are found to have  $T_c$ s around room temperature [35, 36].

Having mapped out the phase diagrams of almost all binary hydrides [32, 37], research focus is currently turning toward ternary systems that are, on the one hand, much more involved than the binary systems due to the sheer number of stoichiometric combinations, yet, on the other hand, offer even more possibilities to find more highest- $T_c$  superconductors.

### 5.2. Current and future challenges

In the following, we want to discuss the two previously mentioned, main classes of high- $T_c$  hydrides in more detail. Figure 6(a) shows the bcc crystal structure of the prototypical covalently-bonded  $\text{XH}_3$ , with H (X) indicated by blue (green) spheres. The volume encapsulated by the red, H-centered ellipsoids indicates regions where the charge density of  $\text{XH}_3$  is higher than that of hypothetical X and  $\text{H}_3$  solids in the same crystal structure. In case the electronegativity of X is only slightly larger than that of H (2.1), which is the case for S (2.4) and Se (2.5), strong covalent bonds are formed along X–H–X (figure 6(b)). For  $X = \text{O}$ , the situation is very different, as due to the increased electronegativity of O (3.4), the charge accumulates around the O atoms (figure 6(b)) leading to more ionic bonds [34]. While the increased ionicity results in an increased ep coupling, it also pushes the crystal beyond its stability limit. This suggests that SC could be even further improved in  $\text{SH}_3$  by making the bonds slightly more ionic, yet not so much as to introduce lattice instabilities.

In contrast to the covalent hydrides, stability and SC in the SLC hydrides, such as  $\text{YH}_6$  and  $\text{YH}_{10}$ , are, in large parts, governed by geometrical constraints, in particular the H–H and Y–H distances. Compounds with higher H

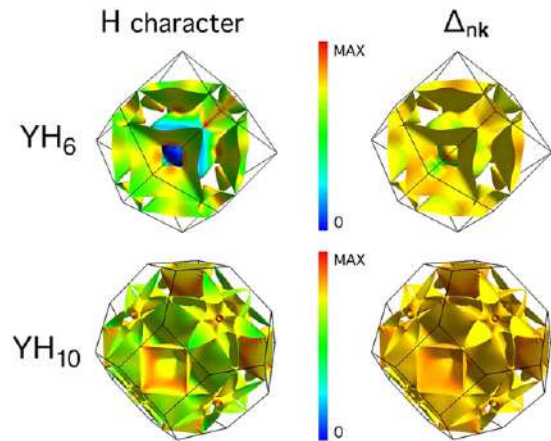

**Figure 7.** FSs of  $\text{YH}_6$  (top row) and  $\text{YH}_{10}$  (bottom row). In the left panels, the color scale spans the projection onto H states where blue corresponds to 0 and red to 1; in the right panels, it spans the values of the anisotropic gap function at 40 K, blue being 0 meV and red the maximum of 59 and 74 meV for  $\text{YH}_6$  and  $\text{YH}_{10}$ , respectively. Reprinted figure with permission from [35], Copyright (2019) by the American Physical Society.

content have shorter H–H distances, which is beneficial for SC, yet require higher stabilization pressures. Anharmonic effects also have a large impact on the stabilization pressure and, in particular, the H–H bond lengths (as demonstrated in  $\text{LaH}_{10}$  [36], for example). Furthermore, interorbital interactions and induced doping between X and H can be strong, meaning these materials cannot be viewed as simple realizations of atomic hydrogen. For example, in the left column of figure 7, the FSs of  $\text{YH}_6$  and  $\text{YH}_{10}$  are shown, with colors indicating the degree of H character, while the right column shows the superconducting gap function, with colors correlating to the gap value [35]. As can clearly be seen, the gap values do not follow the Y and H characters of the FS, demonstrating strong Y–H interactions. Combining host atoms with different sizes, masses, and electronegativities is therefore an appealing route to realize highest- $T_c$  materials at lower pressures [18, 35, 38].

### 5.3. Advances in science and technology to meet challenges

One reason for the rapid progress of research on SC in the material class of hydrides has been the availability of theoretical *ab initio* methods that allow the determination of the most stable structures and the accurate and quantitative calculation of superconducting properties. The former will be discussed at length in section 3 of this roadmap article and the latter in section 4, which enables me to mention a few particular points here most relevant to bonding and ep coupling.

As suggested previously, building upon the currently known high- $T_c$  structures and trying to improve their properties by modifying them is a viable and promising path forward. For the covalent hydrides this means to search for materials with even stronger covalent bonds than those found in  $\text{SH}_3$  [34], and for the SLC hydrides to make use of the tight connection between the guest atoms and the possible geometries of

the system to either increase  $T_c$  or decrease the lower critical pressure of stability [35]. In both cases, this is tantamount to delicately balance the strength of the ep interaction, as a higher ep coupling, beneficial for SC, also brings the material closer to its lattice's stability limits. Ternary (or even quaternary, ...) systems offer a plethora of possibilities to optimize this balance, yet significantly more computational resources will need to be invested as compared to binary systems due to the sheer amount of combinatorial possibilities.

Another interesting aspect related to lattice instabilities in hydrides is the fact that van Hove singularities occur at (SH<sub>3</sub>, LaH<sub>10</sub>) or are close to (PdH, PH<sub>2</sub>) the Fermi level [32, 39]. This means that there is a large electron density available to SC, yet also indicates the proximity to structural instabilities. Of particular significance with respect to near room-temperature superconductors is that around 300 K, temperature effects on the electronic properties are already sizable, affecting also the vibrational and ep properties [40]. Investigating and studying these implications and incorporating them in the current *ab initio* approaches to predict  $T_c$  will be important steps in future research.

#### 5.4. Concluding remarks

The past few years have seen a tremendous progress in the research on ep SC, culminating in the realization of room-temperature SC in 2020 [30]. Even though the first experimental realization of a high- $T_c$  hydride was reported recently in 2014, the scientific community has already gained a lot of knowledge about these materials. Two different main classes have been established so far, categorized based on their bonding properties and geometries, and the origins of their excitingly high  $T_c$ 's have been illuminated. One of the most important future milestones to reach is to bring the required pressures, currently in the megabar range, down to regimes that are easier to handle, by fine-tuning the ep interactions, and optimizing structures and compositions. Judging on past achievements and the current pace of research, I am confident that many interesting and new materials with exciting ep and superconducting properties will be discovered in the near future.

### Acknowledgments

CH acknowledges support from the Austrian Science Fund (FWF) Project No. P 32144-N36.

## 6. Toward hot superconductivity

Russell J Hemley

University of Illinois at Chicago, United States of America

### 6.1. Status

The possibility that superconductivity, among the most notable quantum properties in condensed matter, could exist at room temperatures has been of longstanding speculation since the

discovery of superconductivity itself. That states of zero electrical resistance could persist well above room temperature in condensed matter was suggested by Ashcroft's 1968 prediction [41] that high-pressure, atomic metallic phase hydrogen could exhibit 'conventional' superconductivity arising from strong electron-phonon coupling, a high density of states at the Fermi level, and high frequency phonons of light nuclei. This prediction was followed by more detailed calculations suggesting critical temperatures  $T_c$  above 400 K as well as other exotic forms of this dense quantum metal to multi-megabar pressures [42].

Seeking routes to reduce the pressure of the transition to atomic metallic hydrogen, Carlsson and Ashcroft [43] suggested the use of dopants to stabilize the metallic and superconducting phase, whereby hydrogen-rich compounds and alloys containing atomic hydrogen might be stable at static pressures readily accessible in the laboratory (e.g., <300 GPa). These predictions motivated experimental studies of superconductivity in hydrogen-rich materials and molecular mixtures, work that was later inspired robust computational structure-search methods providing useful predictions for candidate structures and compositions with potential high  $T_c$  superconductivity, again based on 'conventional' (BCS Eliashberg) electron-phonon coupling models.

This effort led to predictions and experimental discovery of high  $T_c$  hydrides formed from p-block elements (e.g., H<sub>3</sub>S), metals (e.g., LaH<sub>10</sub>, YH<sub>9</sub>, YH<sub>10</sub>), and most recently in the C-S-H, now in the vicinity of room temperature [20, 44, 45] (figure 8). It is now recognized that one route to achieving potentially higher  $T_c$  is by exploring the greater chemical landscape. Chemical doping includes substitutions leading to hole doping that can increase the density of states at the Fermi level and/or enhance electron-phonon coupling (e.g., carbon in hydrogen sulfide [46] and boron-nitrogen in lanthanum hydride [45]). The extent to which either occurs in the latter, as suggested by recent preliminary findings, will require additional experiments [45]. Alternatively, electron doping, harkening back to the suggestions of Carlsson and Ashcroft, can further enhance  $T_c$  well into the 'hot' superconducting regime, as predicted for the Li-Mg-H system [25].

### 6.2. Current and future challenges

Current and future challenges are both fundamental and technological. Overarching questions that challenge the field from the standpoint of fundamental physics and chemistry include the following.

(1) What are the highest superconducting  $T_c$ 's possible in condensed matter? What are the fundamental limits, and how can this be realized in materials (as opposed to nuclear matter)? Recent advances have been made by appealing to greater chemical complexity; what are the prospects for more complex alloys, stoichiometries, and/or variable dimensionalities? (2) What is the superconducting mechanism of these low- $Z$  systems when their full quantum character is properly included? Characteristic features of the magnetoresistance properties reported to date do not fit the 'conventional'

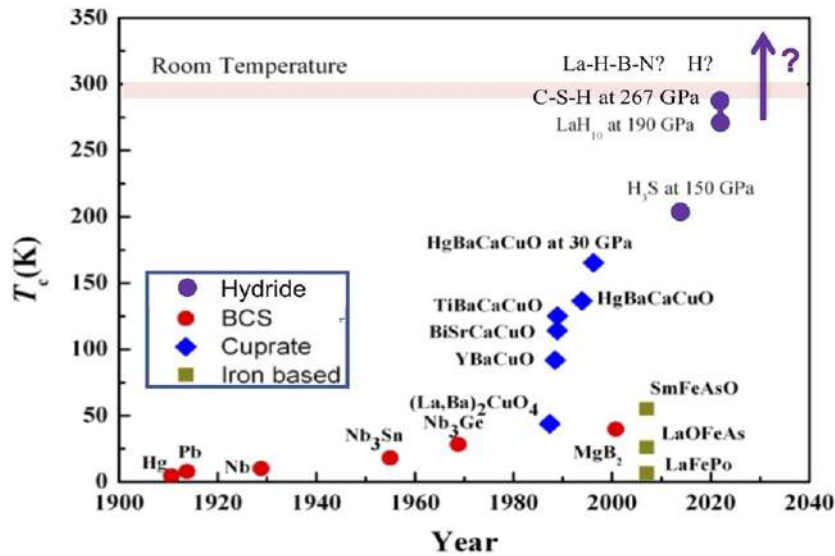

Figure 8. Maximum superconducting critical temperatures  $T_c$  since the discovery of superconductivity in 1911.

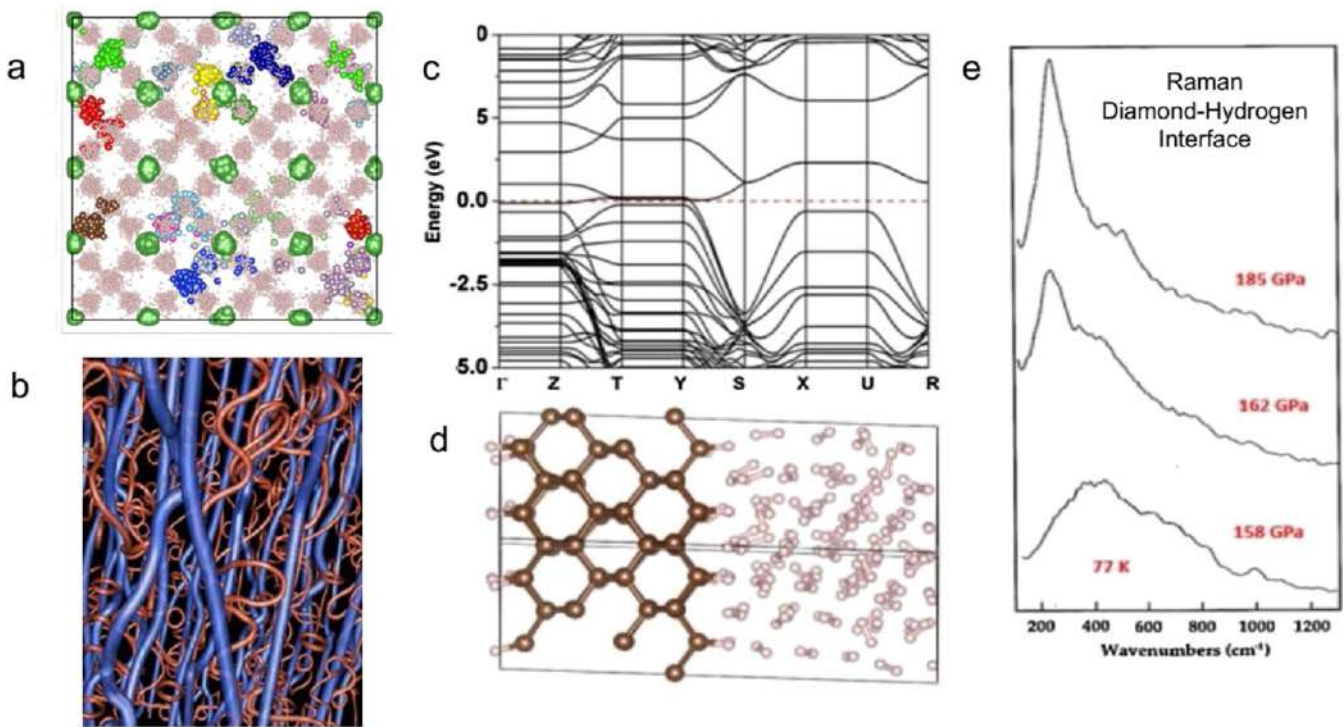

Figure 9. (A) Quantum diffusion and sublattice melting of  $\text{LaH}_{10}$  based on path integral molecular dynamics simulations (150 GPa and 800 K). The displacements of the La atoms (green spheres) and H atoms (pink spheres) are shown (reprinted (figure) with permission from [49], Copyright (2018) by the American Physical Society); (b) vortex structure of superconducting superfluid hydrogen (from Babaev *et al* 2004 *Nature* 431 666–668); (c) band structure of the 111 diamond surface of diamond covered with a hydrogen monolayer at 350 GPa and (d) molecular dynamics simulations of hydrogen in contact with a 100 diamond surface at 300 GPa (Lui *et al*, unpublished); (e) Raman spectra of the diamond-hydrogen interface near 200 GPa indicating anomalous electronic excitations associated with pressure-induced interfacial electronic transitions (reprinted from [50], Copyright (1992), with permission from Elsevier).

description. Yet to be explored in detail are non-adiabatic effects arising from the highly quantum character of the nuclei [47]. (3) How can experiments be improved to further characterize these materials and test proposed mechanisms? Syntheses can be strongly P–T path dependent, the phases may be metastable and have variable crystallinity and homogeneity, and hot hydrogen-rich samples are difficult to contain—all

of which challenge characterization. (4) What additional new physics might be revealed in these low-Z systems? Predictions for pure hydrogen include a possible superconducting superfluid and other novel quantum fluid and solid properties [42]. Do similar phenomena occur in hydrides, and is there a relationship to other novel dense phases such as electrides and topological materials?

Technological questions include the following. (1) How can information gained lead to the creation of new useful materials, thereby extending ‘materials by design’ to enable the creation of novel superconductors? The creation of very high  $T_c$  superconductors stable (or metastable) under ambient conditions may be possible with continued advances in synthetic methods and understanding of these materials. (2) What structures and compositions should be targeted for stabilization? Related carbon-bearing hydrides may persist as high  $T_c$  materials at ambient pressure because of the rigidity of their  $sp^3$  bonding. (3) Could materials be synthesized and stabilized using multiple extreme environments, including magnetic or electric fields? Recent calculations indicate that electrochemical loading could be used to synthesize the materials at modest pressures [48].

### 6.3. Advances in science and technology to meet challenges

Answers to these fundamental questions will be enabled by expanding the number, sensitivity, and resolution of *in situ* probes of materials properties under extreme conditions. These techniques include those that probe local bonding and structure, dynamics, crystal structure, electronic, magnetic and transport properties. The methods will rely on continued development of x-ray synchrotron radiation methods such as nuclear forward scattering for Meissner measurements, inelastic x-ray scattering (both RIXS and x-ray Raman) of absorption edges, and nano-diffraction methods at TPa pressures. Synchrotron infrared (IR) measurements down to the THz range can determine gaps, electron–phonon coupling, and the nature of the normal state to multimegabar pressures. High pressure neutron diffraction and scattering is needed to determine the low- $Z$  (e.g., hydrogen) substructures and dynamics at multimegabar pressures, advances that may be possible with new spallation neutron scattering facilities.

Routine measurements in high magnetic fields ( $10^2$  T) are needed to map out the field dependence of  $T_c$  to establish type I or II character. All of these methods must be sensitive to not only bulk properties, but also interfaces where novel behavior may occur under extreme conditions, including that arising from possible topologically protected states and 2D superconductivity introduced by combining different materials (including diamond and hydrogen) at megabar pressures. In pure hydrogen, the extent to which pressure-induced interfacial metallization and possible superconductivity at the hydrogen-diamond interface could occur prior to the transition in the bulk is suggested by early work that showed reproducible electronic Raman features at the diamond-hydrogen interface (figure 9).

Nanofabrication capabilities will enable *in situ* high pressure measurements of back-gating for carefully tuned electron doping of materials to enhance  $T_c$ , analogous to methods already developed for fabrication of field-effect transistors inside DACs. Finally, there is the continued need to reach higher static pressures with sufficiently large volumes that will allow unambiguous determination and characterization of bulk versus interfacial properties. In addition, there is a

need for combining different *in situ* probes of the same sample subjected to multiple extreme environments (e.g.,  $P$ – $T$ – $H$ – $E$ ).

### 6.4. Concluding remarks

Recent discoveries in this rapidly evolving field represent remarkable advances on the century-old goal of realizing RTSC and the possibility of superconductivity in the ‘hot’ regime. Facilitating this effort is the increasing accuracy of theoretical and simulation methods. Systematic prediction, synthesis, and validation has been shown to be important not only in understanding the mechanisms underlying superconducting behavior, but also for recovering materials exhibiting these properties for practical applications. The overarching fundamental questions highlighted above are deeply tied to broader questions associated with understanding the nature of condensed matter at very high densities in unexplored  $P$ – $T$  regimes of ‘cold’ to ‘warm’ dense matter. Addressing these issues will likely advance our ability to harness this remarkable quantum behavior for practical applications in next-generation materials and devices.

### Acknowledgments

This work was supported principally by the US National Science Foundation (DMR-1933622), and by the US Department of Energy (DE-SC0020340 and DE-NA0003975).

## 7. High pressure hydrogen: a theoretical challenge from the simplest element

*Carlo Pierleoni*

University of L’Aquila, Italy

### 7.1. The phase diagram

Hydrogen is the simplest element in the periodic table and the paradigmatic system upon which our understanding of quantum mechanics of atoms, molecules and condensed phases is based. It is also the most abundant element in the Universe under widely different physical conditions [51]. It is relevant for energy applications both in the inertial confinement fusion program and as green-energy source. Yet its physical behavior under extreme conditions is partially unknown mainly because of experimental difficulties in producing and controlling the relevant physical conditions [52]. The most relevant and still unanswered question is about the mechanism through which hydrogen metallizes. As any other element, if compressed enough it must turn metallic. But is pressure-induced metallization in the crystalline phase accompanied by a structural phase transition, either with or without molecular dissociation, or is it caused by progressive closure of the electronic gap in the same structure? What is the scenario at higher temperature in the fluid phase? Obviously these questions are highly relevant for the still unobserved hydrogen superconductive state which is expected to have a very high critical temperature, probably higher than the melting temperature [52]. Important advances on metallization of solid hydrogen appeared in recent



years. In 2017 Harvard's group announced the observation of metallic hydrogen in the DAC at 495 GPa and below 80 K [53]. This conclusion was drawn by the sudden appearance of a reflective sample above that pressure, interpreted as the first evidence of hydrogen metallization. This interpretation has been criticized by others [52]. At about the same time Mainz's group reported evidence of the formation of a semi-metallic, still molecular, phase at around 350 GPa and below 100 K. They employed both optical probes and direct electric measurements in a DAC. Although they first announced these results in 2017 a final accepted paper appeared only two years later [54]. Finally in 2020 Paris's group [55] reported results of a special geometry toroidal DAC with synchrotron radiation. They could measure the IR absorption profile in a wide range of pressure and detect a full absorption at 427 GPa and 80 K, interpreted as a sudden closure of the direct energy gap, a strong indication of the realization of a 'good metal' state. Although sample visual inspection, reversibility of the transition upon pressure release, and theoretical predictions suggest that this metal is still molecular, a strong experimental evidence is still missing. In figure 10 we sketch the current phase diagram with particular emphasis on the IM region. Below 200 K in phase III we report the transition to the semimetallic state at 350 GPa [54] as a blue-shaded area and the later transition to the 'metallic' state at 425 GPa [55] as a red-shaded area. At 495 GPa we also report the Harvard's group result as a red filled area. Above 200 K phase III transforms into a new phase IV but not much is known about the metallic character of this new phase. Continuous lines are well established phase boundaries. However experimental information about crystalline structures of those phases are missing. Above the melting line (known only up to about 300 GPa) fluid hydrogen can be either molecular or atomic. First-principle simulations, both by Born–Oppenheimer molecular dynamics and by coupled electron–ion Monte Carlo (CEIMC) [51, 61, 62], predicts the existence of a weakly first order liquid–liquid transition (LLPT) between the molecular insulating fluid and the mostly monoatomic metallic fluid below a critical temperature ( $\sim 2000$  K). The precise value of  $T_c$  is not known but above  $T_c$  molecular dissociation and metallization are progressive with pressure. Experiments on fluid hydrogen are performed either by static compression with DAC [58] or by dynamic compression with shock waves techniques [59, 60]. Metallization is detected by a rapid increase in reflectivity with pressure but consensus about the mechanism of metallization and the physical conditions is still missing. In figure 10 we report DAC data from Harvard's group [58] on hydrogen and shock wave data on deuterium from Sandia's group [60] and from Livermore's group [59]. Note that shock wave experiments do not provide complete information about the thermodynamic state, temperature need to be inferred from some model theory and can vary considerably.

## 7.2. A challenge for theory

Why does hydrogen represent a challenge for theoretical methods? The first fundamental reason in the solid is the missing experimental information about the crystalline structure of the

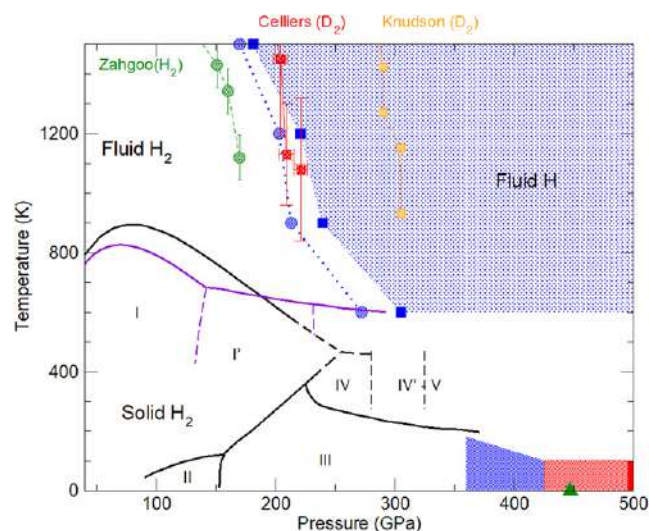

**Figure 10.** Hydrogen phase diagram. Several non-metallic crystal phases have been detected experimentally. The melting line is reentrant and has been measured up to about 300 GPa. Two different lines are reported, one from theory (black continuous) [56] and one from experiment (purple) [57]. The low temperature phase III is where metallization has been measured. The semimetallic state is entered at 360 GPa [54] and indicated by a blue shaded area. It persists up to 425 GPa where a sudden collapse of the direct gap is detected [55]. This is represented by the red shaded area. At 495 GPa a reflective sample has been reported [53] (represented by a dark red vertical bar). Above melting the insulating molecular fluid has been predicted to transform suddenly in a monoatomic conducting fluid (light blue shaded area). Experimental observation of large reflectivity are from DAC (Zaghoo (H<sub>2</sub>)) [58], from shock wave at NIF (Celliers (D<sub>2</sub>)) [59] and from shock waves at Z-pinch (Knudson (D<sub>2</sub>)) [60]. Blue points are CEIMC predictions for the liquid–liquid phase transition [61], squares for H<sub>2</sub>, circles for D<sub>2</sub>.

various phases. The second reason is that nuclear quantum effects for hydrogen are large and very important. At lower pressure in phase I and II, quantum statistics of nuclei determine the orientational order [51]. At higher pressure molecular orientation is determined by correlation but the molecular vibron at  $\sim 4000$  cm<sup>-1</sup> corresponding to  $\sim 0.5$  eV  $\sim 6000$  K testifies the importance of zero-point energy (ZPE) and the requirement for a non-perturbative treatment of quantum nuclei. But overall the most fundamental problem is the lack of a predictive theory for the electronic problem. DFT is the workhorse for molecules and condensed phases and has been successfully used in a large variety of systems but, although in principle exact, in practice approximate exchange–correlation (XC) functionals reduce DFT to a mean–field theory with well know limitations [63]. More important, DFT misses an internal check of the different approximations and their accuracy needs to be established against more fundamental theories like quantum chemistry or quantum Monte Carlo (QMC) methods. In hydrogen this problem is particularly serious because of the simple electronic structure and the absence of other sources of uncertainties like pseudopotentials. Often the accuracy of DFT approximations is established by comparing predictions with experimental results. I argue here that in general this is not acceptable for a theory to be predictive: comparing with experiment is always indirect and can be misleading. In the case of

high-pressure hydrogen moreover experimental data are scattered and the request for a fundamental predictive theory is even stronger.

Crystalline structures of the various phases have been predicted by *ab-initio* random structure search method (AIRSS) based on PBE approximation for phase III and IV [64, 65]. A plethora of structures has been proposed that differ in enthalpy by only few meV/atom which questions the validity of the various approximations in DFT. Some of the proposed structures for phase III have been later examined by QMC [66], finding the *C2/c-24* structure up to  $\sim 400$  GPa, the *Cmca-12* structure between  $\sim 400$  GPa and  $\sim 700$  GPa and the monoatomic Cs-IV structure at higher pressure. Inclusion of nuclear fluctuations in the harmonic approximation over the DFT-PBE ground state energy surface reduces considerably the stability range of *Cmca-12* structure between  $\sim 425$  GPa and  $\sim 450$  GPa, where the Cs-IV structure becomes favored. The green triangle in figure 10 indicates this atomic transition. But can the inferred scenario, based on the harmonic approximation with PBE, be considered quantitative? We still do not have a definite answer to this question. To go beyond the harmonic approximation, path integral molecular dynamics (PIMD) or Monte Carlo (PIMC) can be employed where electrons are still in their ground state (from DFT or QMC) while protons are represented by path integral at finite temperature. These methods allow to investigate temperature effects like structural transitions and melting. While first principle molecular dynamics with classical nuclei and DFT-PBE gives reasonable predictions, for instance for the melting line up to 200 GPa [56], inclusion of quantum nuclei with the same DFT-PBE badly failed [67]. Predictions of other approximations, considering dispersion interactions and providing better structural properties against QMC benchmarks, together with quantum nuclei in PIMD have been compared to the more fundamental CEIMC results where the nuclear configurational space is sampled by PIMC based on the electronic ground state energy by QMC [68–70]. The main outcome of these studies is that the accuracy of a given XC approximation in predicting structural properties not only depends on physical conditions but also on the specific structure considered. However, a CEIMC study of structural stability by free energy calculations is still to be performed.

Not only structural but also electronic properties, like band structures and optical responses, depend on the specific XC approximation in DFT. Being able to predict those properties without experimental input is important to establish the metallicity of the system and to compare with the main experimental probe. Recently we have proposed a controlled method to compute band gaps (and in general band structures) from QMC energies [71, 72]. It is based on size-corrected [73] grand-canonical twisted averaged boundary conditions QMC. In reference [71] we have demonstrated its use and performance in computing the fundamental gap of well-known semiconductors (carbon and silicon), while in references [74, 75] we have extended its use to thermal crystals and disordered systems (like liquids) and applied it to compute the band gap in crystalline [74] and fluid hydrogen [75]. The main results in the quantum-thermal crystals are: (1) the gap reduction by

quantum nuclei is huge and amounts to  $\sim 2$  eV confirming the importance of considering NQE in a non-perturbative fashion; (2) thermal effects on the band gap below 200 K are marginal; (3) the fundamental indirect gap for the considered structures of phase III (*C2/c-24* and *Cmca-12*) closes around 350 GPa (the precise value slightly depend on the structure and on temperature); (4) the density of states at the Fermi level is vanishing small at the gap closure and progressively grows with pressure pointing to the semi-metallic state experimentally observed [54]; (5) computed direct gap values for *C2/c-24* structure fall on top of the data of the recent synchrotron radiation experiments [55] while prediction for *Cmca-12* structure are larger by  $\sim 0.5$  eV; (6) we do not observe the direct gap collapse at 425 GPa experimentally reported [55] and probably caused by a structural transition but we can exclude *Cmca-12* as new structure. We cannot exclude that the reported collapse is caused by a structural transition to an atomic phase; (7) we found the inadequacy of the Kubo–Greenwood theory within DFT (HSE) to reproduce the experimental optical spectra in high pressure hydrogen.

Interesting physics is also observed in the fluid phase. We computed the fundamental gap for hydrogen along isotherms below and above the critical temperature of the LLPT. Below  $T_c$  we find that gap closure is discontinuous with pressure and reflects the molecular dissociation behavior: the molecular-gapped fluid coexists with the atomic-gapless fluid. Above  $T_c$ , molecular dissociation with pressure sets in while the gap is still open. When the gap closes, the decay of the off-diagonal single-electron density matrix shows that the liquid enters a gapless, but still electronically localized phase: there is a crossover between the insulating and the metallic liquids.

### 7.3. Conclusions and perspectives

We have briefly described the present knowledge of hydrogen metallization from experiments and theory both in the low temperature solid and in the fluid phase. We have emphasized the importance of having a predictive theory like QMC, variational in character hence improvable and not based on experimental inputs, and of a thoughtful comparison with experiments. Our theory is still affected by systematic effects like metastabilities in sampling the nuclear configurational space, nuclear finite size effects and finally the variational character of the electronic QMC solution (fermion sign problem). However all these effects can be systematically investigated and improved with enough computational resources in the future.

An important still missing methodology is about computing optical spectra. The most commonly used one is based on the Kubo–Greenwood formalism with Kohn–Sham orbitals (from some DFT approximation). However results are strongly affected by the choice of the XC functional and remain qualitative. We found that this procedure is not satisfactory in hydrogen, even after correcting for the band gap error. A more controlled and improvable procedure is highly desirable in view of the relevance of optical properties in connection with experiments.

Finally our present theoretical framework is entirely based on the adiabatic approximation of separating nuclear and

electronic problems. However when the electronic gap becomes comparable or smaller than the nuclear vibrational energy one may wonder whether this separation is still effective.

## Acknowledgments

I would like to thank all my collaborators and friends that contributed to this work: D M Ceperley, M Holzmann, V Gorelov, G Rillo, Y Yubo, M A Morales. This work was supported by ANR-France under the program ‘Accueil de Chercheurs de Haut Niveau 2015’ project: HyLightExtreme.

## III. Crystal structure prediction methods

### 8. Accelerating the prediction of superconducting complex hydrides

*Maximilian Amsler*

Department of Chemistry and Biochemistry, University of Bern, Freiestrasse 3, CH-3012 Bern, Switzerland  
Department of Materials Science and Engineering, Cornell University, Ithaca, NY 14853, United States of America

#### 8.1. Status

The properties of materials are closely linked to their underlying crystal structure, the arrangement of the constituent atoms in the crystal lattice. Experimentally, the crystal structure of materials can be determined using XRD based on the pioneering work of Bragg and Laue more than a century ago. However, theoretical CSP, the task of solving the crystal structure given solely the chemical composition, has only become possible within the last few decades with the development of advanced CSP algorithms [76] (see figure 11). Such CSP methods play a key role in computational design of room temperature superconductors, since the knowledge of the atomic structure is a prerequisite for any *ab-initio* property calculations. In particular for the current target materials class for high-temperature superconductivity, namely high-pressure hydrogen-rich materials, reliable CSP and property predictions prior to resource-intensive synthesis using DAC is invaluable (see figure 11). Further, light elements like hydrogen scatter x-rays only weakly, rendering solving the structure from XRD especially challenging, and CSP is at times the only possible way to identify the locations of the protons. In fact, the discovery of superconducting hydrides such as  $\text{SH}_3$  ( $T_c$  of 203 K [6]) and  $\text{LaH}_{10}$  ( $T_c$  of 250 K [77]) are based on the theoretical predictions using CSP [78, 79] that have been able to accurately guide the experimental efforts toward the target systems.

At its core, CSP algorithms aim at solving a global optimization problem, namely identifying the global minimum of a potential energy or enthalpy surface (PES) spanned by the coordinates of the atomic positions and the lattice vectors. The number of possible configurations on this high-dimensional PES is immense and grows exponentially with the number of

degrees of freedom. Most CSP methods operate on a transformed PES, where every configuration is first relaxed to its nearest local minimum, thereby reducing the complexity of the PES. But even then, CSP remains an NP-hard problem that is difficult to solve. Most CSP methods aim at finding the ground state by either generating a thermodynamic distribution, e.g., like simulated annealing and basin hopping, or by sampling the low-lying part of the PES as quickly as possible, e.g., using genetic algorithms, particle swarm optimization, or the minima hopping method (MHM) [76].

#### 8.2. Current and future challenges

Despite the triumphant successes and the central role of CSP methods in predicting high-temperature hydride superconductors, major challenges remain to be addressed. Currently, nearly all of the space of binary hydrides has been screened, and efforts have been shifting toward exploring more complex chemistries. Predictions and experimental synthesis of ternary and higher-order hydrides are emerging, as illustrated by the recent report on carbonaceous sulfur hydride and its RTSC [20]. The combinatorial explosion in complexity when tackling such extended chemistries significantly increases the computational cost. E.g., while  $s = 755$  distinct stoichiometries are possible with a 50-atom cell in a binary system,  $s$  exceeds 20000 in a single ternary phase-space. Hence, a careful pre-selection of stoichiometric sub-spaces based on chemical intuition is called for to keep CSP tractable, or the development of advanced methods to accelerate PES evaluations.

Further, the predictions of a CSP method are only as good as the accuracy of the underlying model of the PES: reliable schemes to represent a PES are based on (approximate) solutions of the many-body Schrödinger-equation. The most popular approaches rely on DFT within the Born–Oppenheimer approximation at 0 K, in conjunction with a flavor of a generalized-gradient XC functional. Especially for hydrogen-rich materials, however, the local minima on such PES have been demonstratively shown to provide an inaccurate description of the system: the quantum-nuclear motion of the light elements become increasingly important to correctly rank the energies of the local minima on the PES, their respective transition pressures, and dynamical stability. Including the ZPE or entropic contributions to the free energy from harmonic lattice vibrations give a first-order correction for finite-temperature energetics, but strong anharmonic effects can further affect the phase stability of hydrides [80]. Unfortunately, including such energy contributions in CSP on-the-fly is computationally extremely challenging and beyond the currently available computational capabilities.

#### 8.3. Advances in science and technology to meet challenges

The emerging field of AI and ML show promise to alleviate some of the core challenges in CSP. We identify three distinct areas where ML can actively contribute to accelerate CSP efforts for predicting novel hydride superconductors:

- (a) ML can significantly accelerate CSP with models to accurately reproduce the *ab-initio* PES of complex chemical

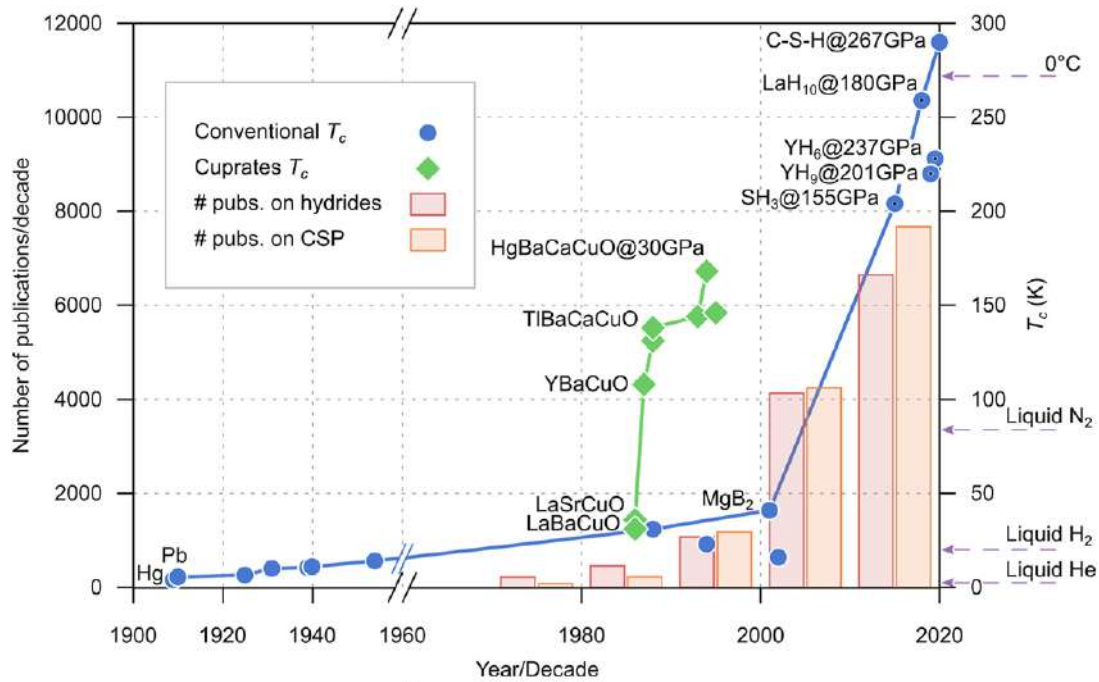

**Figure 11.** The histograms show the approximate number of publications on hydrides and CSP methods per decade (scale on the left y-axis). The rapid increase in the number of publications in these two fields was fueled by Ashcroft’s prediction of high- $T_c$  superconductors through chemical pre-compression of hydrogen in 2004, and the development of reliable CSP methods based on DFT. The blue and green points represent mile-stones in the discovery of conventional and cuprate superconductors, respectively (scale on the right y-axis with some key reference temperatures). The recent rush for hydrides started at the dawn of the 2000s and led to the prediction of various high-pressure hydride superconductors through CSP calculations, and their subsequent synthesis in DACs. In fact, all (super) hydrides (blue circles with center dot in the top right corner) with exception of C–H–S were first discovered through CSP methods.

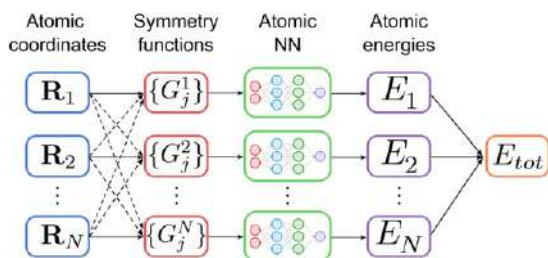

**Figure 12.** A schematic illustration of a feed-forward artificial neural network (NN) potential. A common approach is to map the Cartesian coordinates of the  $N$  atoms in a system to vectorial environment descriptors, such as the Behler-type symmetry functions, which are then fed into atomic NNs. The output of those NN, the atomic energies  $E_i$ , sum up to the total energy  $E_{tot}$  of the given configuration. Such NN potentials can be trained on DFT reference data and reproduce the *ab-initio* PES with high accuracy at reduced computational cost.

systems. Such atomic ML-potentials, e.g., based on artificial neural networks (see figure 12) or Gaussian processes, have very flexible functional forms and can be trained on accurate, but expensive, DFT reference data to represent them at essentially arbitrary precision, providing total energies and their derivatives at the level of *ab initio* methods at a fraction of their computational cost. The process of training ML-potentials, including the generation of reference data and model validation, have been recently integrated in frameworks to perform CSP

simulations and show promise in improving their performance for complex materials prediction [81].

- (b) To further improve the accuracy of the PES representation beyond zero-temperature predictions, ML methods are also emerging to accelerate the expensive computation of dynamical properties. Compressive sensing lattice dynamics (CSLD) for example employs techniques originally developed in signal processing for recovering sparse solutions from incomplete data, and allows to extract (an)harmonic force constants with very few DFT total energy calculations [82]. With CSLD, the important contributions of ZPE, vibrational free energy, and anharmonic phonon renormalization in hydrides become accessible to allow a rapid and accurate assessment of hundreds of candidate phases [83].
- (c) Multi-objective optimization efforts are becoming increasingly effective to identify a set of optimal solution to several objective functions, i.e., Pareto fronts which consist of all non-dominated solutions. Obvious choices for the target objectives are the stability (e.g., enthalpies from DFT calculations) and the target property (e.g., the superconducting transition temperature). Unfortunately, the accurate assessment of  $T_c$  from electron–phonon coupling is still computationally expensive, and most efforts so far have been limited to properties that can be computed rather quickly [84]. Efficient and accurate ML-based models to predict  $T_c$  without the need for explicitly computing the electron–phonon coupling

together with crystal structure optimization will allow the screening for new superconductors with optimized chemistry/structure and high  $T_c$  across a wide chemical and configurational range.

#### 8.4. Concluding remarks

Even though reliable CSP has become feasible over the last two decades, it remains challenging for complex chemical systems with more than two distinct elements. The emerging field of ML and AI has the potential to assist CSP efforts by reducing the computational cost of accurate PES evaluation, and by guiding multi-objective optimizations. These tools will pave the road to predict complex superconducting hydrides in ternary or higher-order systems that will be potentially synthesizable at lower pressures and/or recoverable to ambient conditions.

#### Acknowledgments

MA acknowledges support from the Swiss National Science Foundation (Project P4P4P2-180669).

### 9. *Ab-initio* structure search orientated discovery of high temperature superconductivity in pressure-stabilized superhydrides

Hanyu Liu and Yanming Ma

Jilin University, People's Republic of China

#### 9.1. Status

A superconductor that works at room temperature has been a long-pursued dream of physicists since the observation of the first superconductivity (conduction of electricity without resistance) below 4 K in solid mercury in 1911 [85, 86]. Through the following more than one century intensive study, the dream is now becoming true in the superconductor system of pressure-stabilized superhydrides (e.g.,  $\text{LaH}_{10}$  [10, 18, 79, 87]). Research activity on superhydrides is inspired by the proposal of high superconductivity in a metallic form of element number one, hydrogen, which is able to create a good phonon-mediated superconductor that naturally accommodate high Debye temperature and strong electron–phonon coupling necessary for mediating electron pairing.

Research on unknown superhydrides is challenging since superhydrides are achievable only at megabar pressure conditions where little information is known on the compositions and crystal structures. The state-of-the-art CSP methods come to the center of the stage since they have trustable power on prediction of compositions and structures. As such, theory has orientated major findings of best-ever known superconductors in  $\text{H}_3\text{S}$  and a class of clathrate superhydrides (e.g.,  $\text{YH}_6$ ,  $\text{YH}_9$ , and  $\text{LaH}_{10}$ ) with  $\text{LaH}_{10}$  holding a record high  $T_c$  value at 250–260 K [85]. The clathrate structure was proposed for the first time in  $\text{CaH}_6$  [88] and can be viewed as metal-doped metallic hydrogen. This structure is an ideal superconducting

hydride model in which hydrogen adopts an atomic form and contributes majorly to the electron density of state at Fermi level.

Binary hydrides have been exhaustively investigated by either simulations or experiments.  $\text{LaH}_{10}$  remains as the best superconducting example up to date. To search further for a room-temperature superconductor, ternary or quaternary superhydrides are promising candidates as we have already demonstrated by designing a ternary clathrate  $\text{Li}_2\text{MgH}_{16}$  superconductor that can be regarded as a ‘hot’ superconductor with a theoretical  $T_c$  value reaching 470 K at 250 GPa [25]. Recent experiment did measure a high  $T_c$  value at 288 K in the C–S–H system [20] though composition and structure information are missing. As the number of elements increases the number of conceivable superconducting structures grows rapidly, bringing ternary or quaternary superhydrides to be better hunting ground for room-temperature superconductors.

#### 9.2. Current and future challenges

A high  $T_c$  superconductor found in superhydrides has to take advantage of the peculiar role of hydrogen played for promoting the superconductivity. A necessary condition for high superconductivity is to have a large hydrogen-derived density of state at Fermi level [86] but this is not easily achieved. Two hydrogen atoms are so happy to stay together for an  $\text{H}_2$  molecule by formation of a sigma bond. Such a bonding will inevitably lower a major portion of hydrogen electrons in energy down far below Fermi energy, leading to a less hydrogen populated FS. This is true for most of superhydrides studied thus far that contain a rich amount of  $\text{H}_2$  units (or other molecular units) in the lattice where the superconductivity is either not reported or reported in a low  $T_c$  value [86]. ‘Hydrogen atomization’ is a useful strategy to bring hydrogen electrons back to the FS, where the hydrogen atoms share their electrons like a metal, rather than forming an  $\text{H}_2$  molecule. To achieve this, the sigma bond of an  $\text{H}_2$  molecule is broken via the acceptance of extra electrons in the antibonding state. Such ‘hydrogen atomization’ behaviors have been well demonstrated in the cases of clathrate  $\text{CaH}_6$  and  $\text{Li}_2\text{MgH}_{16}$  [25, 88]. On the way to a room temperature superconductor among multi-elements hydrides at strong compression, the big research issue here is on how to stabilize a superhydride that contains as much as possible hydrogen but without having any  $\text{H}_2$  molecule in the lattice. Theory here must play a critical role for such an elaborate design that could shed light on future research direction for experimental exploration.

Comparing with the binary system, there is exponentially increased number of possible structures in ternary and quaternary systems. For a theoretical design of high  $T_c$  superconductors in multi-elements superhydrides, one also has to deal with a challenging issue on computation of a vast number of structures during the structure searching simulations in order to locate the globally stable structure. Computational cost will be extremely high if geometric optimization and total energies of all the target structures are computed by using *ab initio* methods. Apparently, there is a desire on the development of

highly efficient method on total energy calculations in an effort to accelerate the structure searches.

### 9.3. Advances in science and technology to meet challenges

The era of theory-orientated hunt for high-temperature superconductors in superhydrides comes together with the development of the state-of-the-art structure prediction techniques [86]. Given the information of chemical compositions, structure-searching methods combined with *ab initio* calculations, without having any prior information about the arrangement of atoms, can precisely identify the thermodynamically stable structures of materials [86]. Besides the above-mentioned theory-orientated findings of H<sub>3</sub>S and a class of clathrate superconductors (e.g., LaH<sub>10</sub>), *ab initio* structure search also directed the finding of anti-Wilson transition: a good metal of sodium becomes a transparent insulator at megabar pressures, violating the wisdom of traditional Wilson transition [89]. Thanks to the rapid development of these crystal-structure searching methods, design of room-temperature superconductor in multi-elements superhydrides having hydrogen atomization in the structure becomes feasible.

ML potential can be used to evaluate total energy of the structure at a rather low cost [90]. The combination of structure-searching method with ML potential in an on-the-fly manner could efficiently accelerate the structure prediction of ternary, quaternary, and even more complex systems, making the design of high-temperature superconductors in multi-elements systems possible.

### 9.4. Concluding remarks

In summary, multi-elements (e.g., ternary and quaternary, etc) superhydrides are promising candidates for hunting room-temperature superconductors, as inspired by the prediction of a ‘hot’ superconductor in a clathrate Li<sub>2</sub>MgH<sub>16</sub> [25] and observation of a near room-temperature C–S–H superconductor [20]. We argue that a deliberate stabilization of superhydride structure with a full hydrogen atomization at high pressure is a necessary condition for a room-temperature superconductor. We warn that *ab initio* structure searching simulations in ternary or quaternary superhydrides are challenging due to the extremely high computational cost on the geometric optimization and the evaluation of total energies of the vast number of structures. The combination of structure-searching method with ML potential in an on-the-fly manner is a useful scheme to accelerate the structure searching simulations for fast screening the structures in order to locate the thermodynamically stable superconducting structure. One may anticipate that room-temperature superconductor will be captured soon in pressure-stabilized superhydrides.

## Acknowledgments

This work was supported by the National Natural Science Foundation of China (Grant Nos. 52090024 and 12074138), the Science Challenge Project (Grant No. TZ2016001), the

Fundamental Research Funds for the Central Universities (Jilin University, JLU), the Program for JLU Science and Technology Innovative Research Team (JLUSTIRT), and the Strategic Priority Research Program of the Chinese Academy of Sciences (Grant No. XDB33000000).

## 10. *Ab initio* structure prediction accelerated with machine learning interatomic potentials

Aleksey N Kolmogorov

Binghamton University, United States of America

### 10.1. Status

Structure prediction methods developed over the past two-three decades are reshaping the process of materials discovery. The methodology is now widely used to screen large spaces of atomic configurations and compositions for new synthesizable materials using little to no structural input [13]. Identification of thermodynamically stable phases with brand-new structure prototypes is particularly important in the search for materials with fundamentally different properties, as illustrated by recent discoveries of superconductors with record-breaking critical temperatures under high pressures.

Unconstrained optimization algorithms capable of constructing ground state configurations ‘from scratch’ rely on a variety of strategies: basin-hopping efficiently maps local minima, particle swarm optimization navigates the energy landscape with crowd intelligence, random searching samples the space in an unbiased fashion, evolutionary engine optimizes structure populations by propagating beneficial traits, etc. Nevertheless, *ab initio* identification of crystalline ground states with 20–30 atoms per unit cell at a single composition may still take tens or hundreds of thousands CPU hours.

An increasingly popular approach to speeding up unconstrained optimization involves introduction of certain constraints and biases. The use of lattice vectors, symmetry, or seeds in the form of known structures has been shown to reduce the computational cost of locating complex global minima by orders of magnitude [91]. The effectiveness can also be improved by simultaneous optimization of structures across a range of compositions or sizes. However, the ‘no free lunch’ theorem necessitates finding a balance between preferentially steering the search toward symmetric or natural motifs and adequately sampling less promising configurations.

An independent route to accelerating structure prediction centers on the use of computationally inexpensive interatomic potentials to select viable candidate structures for further examination with more accurate methods. The strategy has been used since the early days of structure prediction but its success has been limited by the traditional models’ poor transferability. Efforts to improve the reliability of classical description include the development of ‘learn-on-the-fly’ protocols [92] to re-fit potentials during the exploration of the configurational space and the introduction of ML frameworks to describe wider ranges of configurations [93]. The following discussion focuses on the progress and prospect of using ML interatomic potentials (MLIPs) in CSP (figure 13).

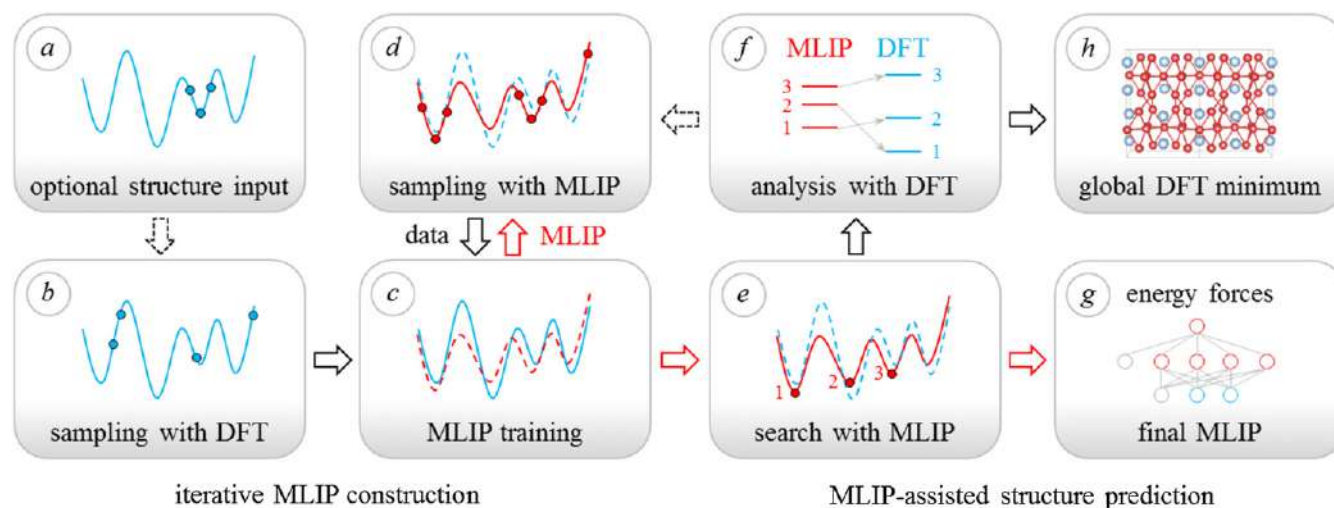

**Figure 13.** A workflow example of structure prediction accelerated with a MLIP. Reprinted from [91], Copyright (2021), with permission from Elsevier. Precursive data includes (a) optional user-defined sets of common structures and (b) configurations generated with DFT-based evolutionary sampling. Iterative MLIP construction comprises (c) MLIP training on all available DFT data and (d) MLIP-based evolutionary data generation. MLIP application involves (e) structure space exploration with the MLIP and (f) examination of MLIP minima with DFT. The process outputs (h) final MLIP and (g) DFT ground state structure(s). Optional steps are shown with dashed arrows.

### 10.2. Current and future challenges

Development of transferable MLIPs departs from the common practice of casting the physics of particular interactions into rigid functional forms. Instead, many-body effects are captured by leveraging the interpolation power of general-purpose flexible ML architectures. Extensive research has shown that accurate approximation of DFT PES is possible with diverse ML techniques, from linear regression and Gaussian processes to (deep) neural networks, provided that atomic structures are properly sampled and parsed [93–101].

**Representation of atomic environments.** Conversion of relevant structural information into ML-compatible input is the foundation of ML model design. Considering that standard ML frameworks expect a constant number of input variables, first models developed in the late 1990s and early 2000s were restricted to systems with either a fixed size or a certain morphology. In 2007, Behler and Parrinello [93] introduced the first successful descriptor that represented arbitrary atomic environments with tunable sets of symmetry functions invariant to translation, rotation, and identical atom swap. Alternative approaches developed in recent years, such as the smooth overlap of atomic positions, moment tensors, atomic cluster expansion, and many others, provide a number of options for finding a desired trade-off between accuracy and speed [94, 95]. The most recent analysis of representation completeness has revealed remaining deficiencies of many existing descriptors and the need for new practical solutions [95].

**Generation of reference data.** Given the ML frameworks' notoriously poor function as extrapolators, careful mapping of relevant regions of the configuration space is another critical step in the development of MLIPs. Common data generation strategies include selection of snapshots along molecular dynamics trajectories, randomization of common (meta)stable structures, and inclusion of custom geometries. Sets of physically meaningful configurations produced with

these approaches have been used to develop MLIPs for various simulation types. At the same time, it has been recognized that generation of unfamiliar diverse configurations appearing in global structure searches requires the introduction of unsupervised iterative schemes, e.g., the evolutionary sampling [96, 97], *ab initio* random structure searching [98], and others listed in reference [91]. Nevertheless, artificial stabilization of non-sampled unphysical motifs may occur even after several data generation and MLIP (re)parametrization cycles.

### 10.3. Advances in science and technology to meet challenges

The abundance of recent successful ML designs and implementations has not yet translated into a large-scale use of MLIPs in CSP. In fact, only a handful of thermodynamically stable materials have been identified with the help of MLIPs so far [91, 100]. Further effort to tune and automate the MLIP construction is needed to make the methodology a vital part of the materials discovery process.

**Optimization of MLIP-assisted prediction.** Computational cost of generating DFT reference data and fitting the PES should be carefully balanced against the expense of exploring structure spaces with the MLIP and examining select candidates with DFT. For typical crystalline alloys, a one-time investment into building an accurate MLIP is comparable to the cost of running thorough DFT-based searches at a single composition [91]. For systems with complex PES, checking viable structures with DFT during the search [91] or refitting MLIPs on-the-fly can significantly reduce the cost of structure selection and local optimization [99]. Overall, the MLIP utilization in the exploration of multicomponent chemical systems is expected to accelerate *ab initio* structure prediction by at least an order of magnitude.

**Automation of MLIP development.** Construction of classical interatomic potentials has traditionally involved a

considerable manual effort and presented a high barrier to entry for new users. Recent introduction of the GAP-RSS framework [98], ML extension to USPEX [99], MAISE-NET wrapper [91], and other platforms has made it possible to streamline all stages of the MLIP generation, validation, and application. Comparison of the implemented algorithms across materials classes will help improve the ML performance and reduce user supervision.

**Data and model sharing.** Open access to the reference data and developed MLIPs will also help establish the best data generation protocols and MLIP architectures. LAMMPS (<https://lammps.sandia.gov/>) and OpenKIM (<https://openkim.org/>) are some of the popular platforms well-suited for sharing MLIPs with standardized formats. Since the scope of the MLIP applicability is determined by the underlying data set, addition of specific configurations can simplify the MLIP (re)parameterization for target applications. A systematic construction of MLIPs for compounds, for instance, can be performed from the bottom up using the stratified training approach [91, 97].

#### 10.4. Concluding remarks

The practice of accelerating *ab initio* structure prediction with inexpensive classical interatomic potentials is experiencing a renaissance due to the recent development of ML modeling methods. The growing number of benchmark studies and proof-of-principle predictions demonstrate that the use of MLIPs can speed up the identification of crystal structure ground states by order(s) of magnitude. With further community-wide effort to test, optimize, and automate computational frameworks for MLIP-assisted structure prediction, the methodology holds great promise to boost the rate of materials discovery.

#### Acknowledgments

ANK acknowledges the support through the NSF Award No. DMR-1821815.

### 11. Searching for high-temperature superconductors at normal pressure

Nikita Rybin<sup>1</sup>, Dmitry Novoselov<sup>1,2,3</sup>, Vladimir Anisimov<sup>2,3</sup> and Artem R Oganov<sup>1</sup>

<sup>1</sup>Skolkovo Institute of Science and Technology, Russia

<sup>2</sup>M.N. Mikheev Institute of Metal Physics of Ural Branch of Russian Academy of Sciences, Russia

<sup>3</sup>Ural Federal University, Russia

#### 11.1. Status

Search for novel superconductors, aiming at RTSC, is an endeavor with a century-long history. After the groundbreaking discovery of high-temperature superconductivity in complex oxides, cuprates [102], with the highest recorded  $T_c$  of 135 K at ambient pressure and 166 K at high pressure, the

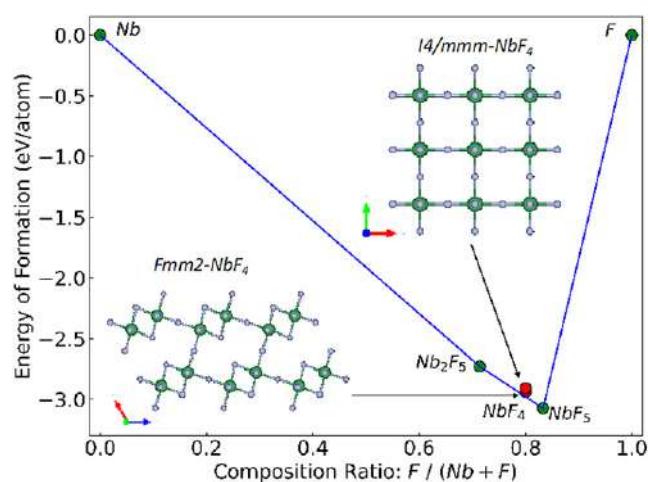

**Figure 14.** Convex hull of the Nb–F system at zero pressure and zero temperature. Insets show crystal structures of  $14/mmm$ - $\text{NbF}_4$  and  $Fmm2$ - $\text{NbF}_4$ . Calculations were done using VASP code [110] with the PBE XC functional.

next milestone was achieved in hydrides at megabar pressures [18], culminating in the discovery of RTSC in a C–S–H at pressures over 2.5 Mbar [20]. Recall that while superconductivity in high- $T_c$  hydrides is due to well-understood electron–phonon coupling, cuprates superconduct, probably, due to coupling of electrons with magnetic fluctuations. Note also that high- $T_c$  hydrides are unlikely to exist at normal pressure–temperature conditions. While the cuprate route is seemingly exhausted, new avenues may open up. What if, instead of oxides (cuprates), one looks at fluorides of d-elements?

#### 11.2. Current and future challenges

In 2001, Grochala and Hoffman [103] highlighted potential high- $T_c$  superconductors in the Ag–F system, based purely on chemical intuition and simple calculations. In 2019 the silver route to superconductivity got a second boost, both theoretically and experimentally [104]. Similar proposals have been made for copper fluorides [105] and niobium fluorides [106]. If high- $T_c$  superconductivity will eventually be discovered in a new class of compounds, such as fluorides, this would be of an enormous interest to the community. Progress in this direction depends largely on CSP, and we want to highlight that particular care with such calculations must be exercised in order to make genuinely solid progress—here we illustrate this point.

For example, a monolayer of  $\text{NbF}_4$  was found via data mining [107] and later predicted to have electronic properties similar to those of cuprates [106]. Tetravalent niobium, expected in the proposed  $14/mmm$  structure, with corner-sharing  $\text{NbF}_6$  octahedra, should be magnetic and, being a spin-1/2 system, should display magnetic fluctuations. However,  $14/mmm$ - $\text{NbF}_4$  is metastable and should decompose into a mixture of  $\text{NbF}_5$  and  $\text{Nb}_2\text{F}_5$ , as can be seen in calculations (figure 14) and was mentioned in the experimental paper [108]. Moreover, using USPEX package [109] we have found a lower-energy  $Fmm2$ - $\text{NbF}_4$  structure, which has energy lower than  $14/mmm$  by 32 meV/atom. This structure is also layered, but has a



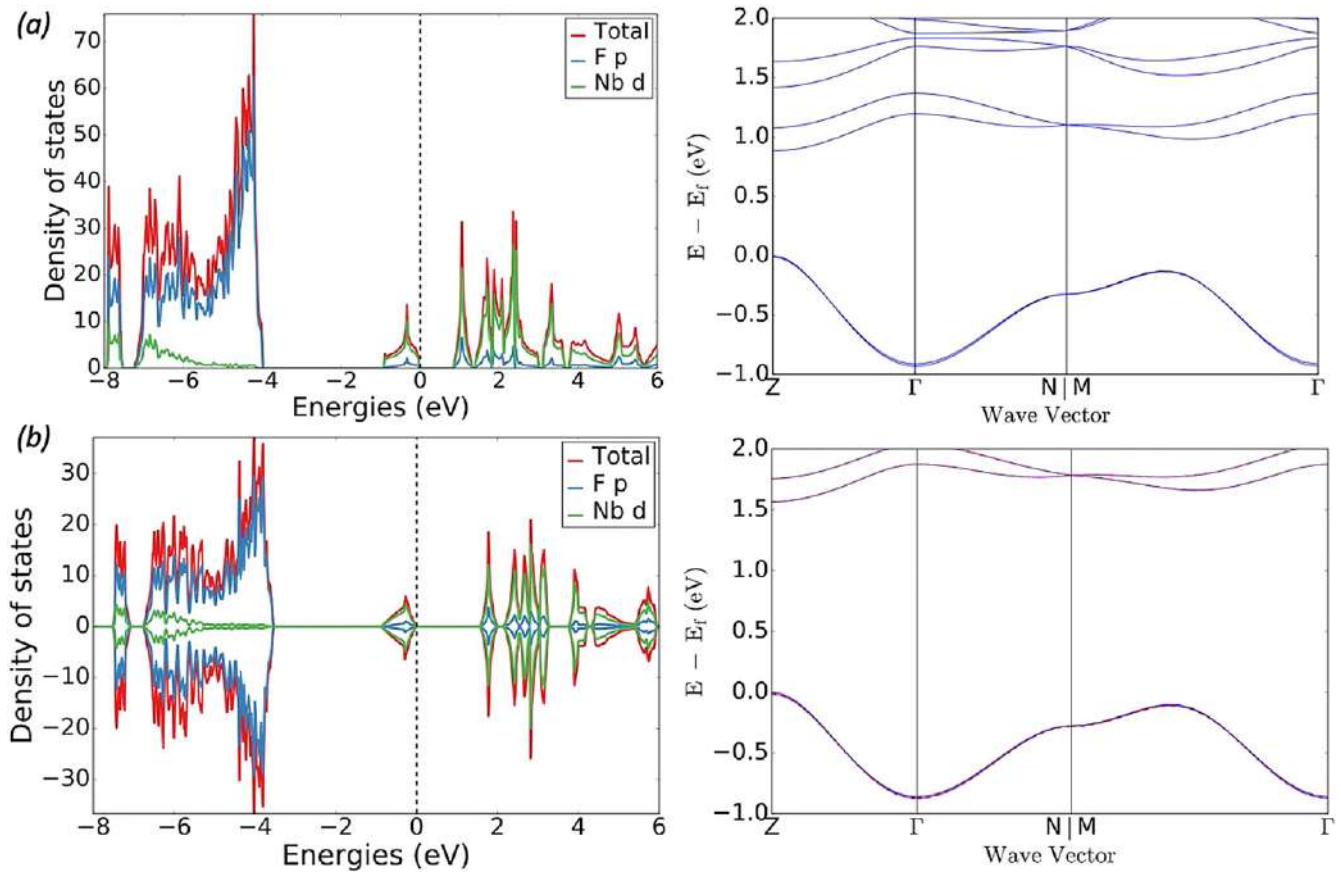

**Figure 15.** Total and partial density of states and band structure of *Fmm2*- $\text{NbF}_4$  calculated by (a) DFT and (b) DFT +  $U$ .

completely different topology and is not an analog of cuprates, decreasing hopes for superconductivity. *Fmm2*- $\text{NbF}_4$  contains pairs of edge-sharing  $\text{NbF}_6$  octahedra, indicating a Nb–Nb bond across the shared edge and pentavalent Nb atoms (four valences are used for bonding with fluorides, and one—with niobium), which have no local magnetic moment.

Density-functional calculations (using the PBE XC functional) show that *Fmm2*- $\text{NbF}_4$  is an insulator with the band gap of  $\sim 0.9$  eV and non-magnetic ground state (figure 15(a)), which excludes cuprate-type superconductivity. Taking electronic correlations into account, using the DFT +  $U$  method [111] with the Coulomb interaction parameter  $U = 2.7$  eV and the exchange interaction parameter  $J = 0.45$  eV [112], faint hope for superconductivity reemerges: we could stabilize the antiferromagnetic state. Now, the band gap increases to  $\sim 1.5$  eV, but other aspects of the electronic structure are quite similar to the pure DFT result (figure 15(b)): the top of the valence band is formed by the doubly degenerate Nb-4d band predominantly of  $3z^2-r^2$  symmetry, well separated from the underlying states, which confirms the  $5s^04d^1$  configuration of niobium. The bottom of the conduction band is also formed by the d-states of niobium.

### 11.3. Advances in science and technology to meet challenges

Data mining-based CSP can be dangerous, as shown above. We expect evolutionary algorithms to perform better at finding

ground-state structures, but they also have pitfalls. All such algorithms struggle with very large structures ( $>100$  atoms/cell is difficult,  $>200$  atoms/cell usually impossible to handle with today's algorithms), and all (except USPEX algorithm [109]) require stoichiometry to be input and will usually miss phases with unusual or unexpected stoichiometries. For example, recent predictions for the Cu–F system [113] and Ag–F system [114] are incomplete for this reason. For example, recently we have found one hitherto unknown phase *C2/m*- $\text{Cu}_2\text{F}_5$  [105]. Moreover, our brief screening of Ag–F system using variable-composition search revealed some hitherto unknown stable phases in Ag–F system (these results would be published in a separate publication). Therefore, only variable-composition searches could shed light into the whole chemical space of a particular system, and assess the chances of finding new materials with high- $T_c$  superconductivity.

For example, recent predictions for the Cu–F system [113] and Ag–F system [114] are incomplete for this reason. In the Cu–F system, recently we have found one hitherto unknown phase *C2/m*- $\text{Cu}_2\text{F}_5$  [105]. Moreover, our brief screening of the Ag–F system using variable-composition search revealed some hitherto unknown stable phases in Ag–F system (these results will be published in a separate paper). Therefore, only variable-composition searches could shed light into the whole chemical space of a particular system, and assess the chances of finding new materials with high- $T_c$  superconductivity.

### 11.4. Concluding remarks

Now it is clear that RTSC is indeed possible [20], at least at megabar pressures. To bring it to normal pressure, we need to search for new classes of compounds—probably not cuprates (where progress has been exhausted) and not hydrides (high- $T_c$  superhydrides, such as  $H_3S$  and  $LaH_{10}$ , can only exist at high pressure). We believe that there exists a chance for further breakthroughs in high- $T_c$  superconductivity due to the sheer size of the chemical space. One is inspired to look at systems bearing similarity to superhydrides (perhaps, carbides or borides with strong electron–phonon coupling, or compounds of lithium or iodine—closest analogs of hydrogen) and cuprates (replacing oxygen with its closest analogs—sulfur or fluorine, and exploring analogs of copper, various d-elements with fluctuating spin-1/2 state). Among such systems are fluorides of Ag, Cu, Nb, all suggested by computational studies. Here we wanted to highlight that computational results involve many subtleties and require care and cross-checks. The role of computations is to indicate promising systems; the final word will belong, however, to experiments.

### Acknowledgments

We thank the Russian Science Foundation (Grant 19-72-30043) for support.

## 12. Pushing the limits of structure prediction in the search for superconducting hydrides

Chris J Pickard

University of Cambridge, United Kingdom

### 12.1. Status

Modern first principles CSP methods were born to the hunt for room temperature superconductivity in the dense hydrides. In 2006 Ashcroft and Hoffmann proposed [115] silane ( $SiH_4$ ) as a candidate for the chemical precompression of hydrogen, focusing on crystal structures that were derived from chemical intuition, and the ‘rounding up of the usual suspects’. The first published application, and introduction, of AIRSS, uncovered more stable, but semiconducting, silane phases, pushing any expected superconductivity to higher pressures [116]. The experimental synthesis of predicted structures in silane [117], and later, alane ( $AlH_3$ ), alerted the community to the predictive power of these emerging computational techniques. Combined with experimental advances, and computational tools for the reliable computation of conventional superconductivity, first principles CSP has played a central role in the discovery of novel superconducting hydride compounds [118].

In time, first principles structure prediction, either random search, evolutionary, or swarm based, has become the technique of choice for the computational discovery of candidate structures. Increasing computational resources, and robustness of the methods, have enabled the exploration of compositional space. The predicted decomposition of water,  $H_2O$ , at terapascal pressures [119] foreshadowed the decomposition of

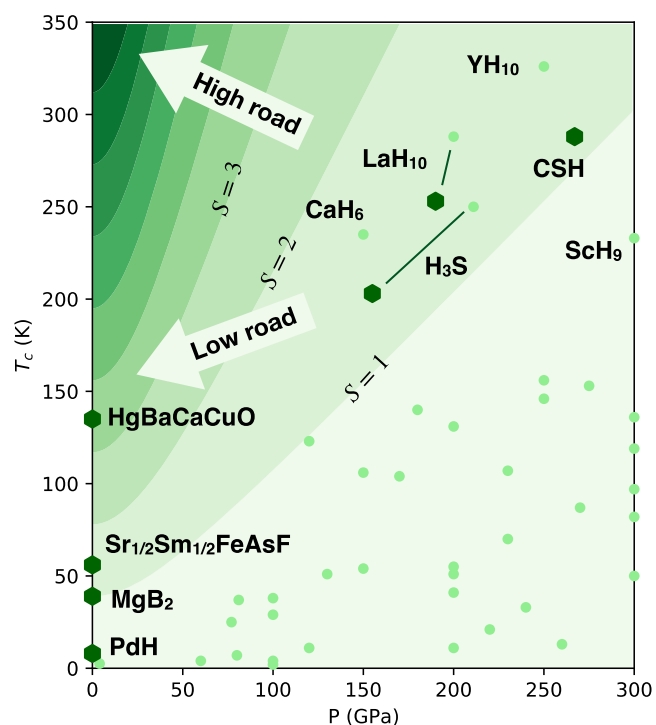

**Figure 16.** Plot of superconducting transition temperature ( $T_c$ ) with pressure ( $P$ ) for a range of experimental (large dark green hexagons) and theoretical (small light green circles) superconducting hydrides. Contours of the figure of merit,  $S = T_c / (T_{c,MgB_2}^2 + P^2)^{1/2}$ , which emphasises the desirability of lower pressures, are plotted. The ‘high road’ takes us to uncharted territory—superconductors with transition temperatures well above room temperature at ambient conditions. The ‘low road’ leads us to new high temperature conventional superconductors to rival to the cuprates.

hydrogen sulphide,  $H_2S$ , to form the record-breaking superconductor  $H_3S$ . The effective parallelisation of the search over the many active research groups has led to a very large number of promising candidates (see figure 16). While relatively few of them have been experimentally realised, the computationally directed search has culminated in the prediction of high temperature superconductivity in the rare earth hydrides [87], which was subsequently confirmed experimentally, again breaking records.

The recent discovery of room temperature superconductivity in the C–S–H system at multi-megabar pressures [20] was not directly led by structure prediction, and indeed, at the time of writing, presents a challenge to our understanding. While computationally predicted high temperature superconductivity appears to be ubiquitous, experimentally this is not the case—another challenge. However, the opportunities are clear for further development, through the exploration of more complex, ternary compounds and beyond, dynamically stabilised phases, or through the abandonment of hydrogen entirely. The field has provided a most compelling case for computational materials discovery, and inspires many other areas of research.

### 12.2. Current and future challenges

The key scientific challenge is the design and synthesis of high temperature conventional superconductors at low,

ultimately ambient, pressures. Given the importance of pressure for the metallisation of hydrogen, it is far from clear that this will be achieved for the hydrides. Nevertheless, the progress made highlights a clear path forward. In the short term, a more thorough computational and experimental exploration of binary and ternary compositions will reveal the lower pressure limit to high temperature superconductivity. The lower this pressure is the better, as it will lead to the expansion of the experimental community, in turn permitting more detailed experimental measurements on the superconducting state. It is likely that ambient conditions room, or high, temperature conventional superconductivity will only be accessible if a wider range of light elements are considered. This means much larger compositional spaces must be managed.

The key technical challenge facing the field is the discrepancy between the number of predicted superconducting hydrides and the number that have been synthesised, and confirmed as high temperature superconductors. While in part this is due to the difficulty of performing the experiments as such high pressures, it is important to be able to theoretically suggest structures which have a high chance of being synthesised. In many cases metastable phases promise higher transition temperatures than the stable one, which will typically exhibit a lower density of states at the Fermi level. But which metastable phases should be presented as viable candidates for synthesis? There are vastly more unstable or metastable phases than stable ones, so choosing between them is important. A theoretical understanding of the kinetically available synthetic pathways is challenging, but central to reducing the overprediction of high temperature superconductors. Similarly, dynamical effects on the stability and synthesisability of phases are important.

As the field matures, a recognition of the importance of microstructure, such as grain-boundaries and interfaces, and disorder to the superconducting properties will increase. Experimentally synthesised phases will in many cases deviate from the ideal stoichiometry, or contain impurities. Doping will allow the tuning of the electronic structure, and might provide a route to the ultimate superconducting properties, along with the combination of conventional and unconventional pairing mechanisms.

### 12.3. Advances in science and technology to meet challenges

The challenge of exploring a much larger space of chemical compositions, and metastable phases, can be met through technological advances in high throughput computation. Predicting the low enthalpy structures of a given composition can be performed independently of others. In particular, in the development of the sampling-based method of random structure searching [120] great attention has been focused on maintaining strict parallelism. AIRSS is routinely used on thousands of compute cores. There is no fundamental reason, beside financial and environmental cost, that structure prediction should not scale to the millions of computer cores that are now available. The greatest difficulty is the management of the extremely rapid rate of data accumulation. Care is required to ensure adequate data parallelism. How strong a case can be

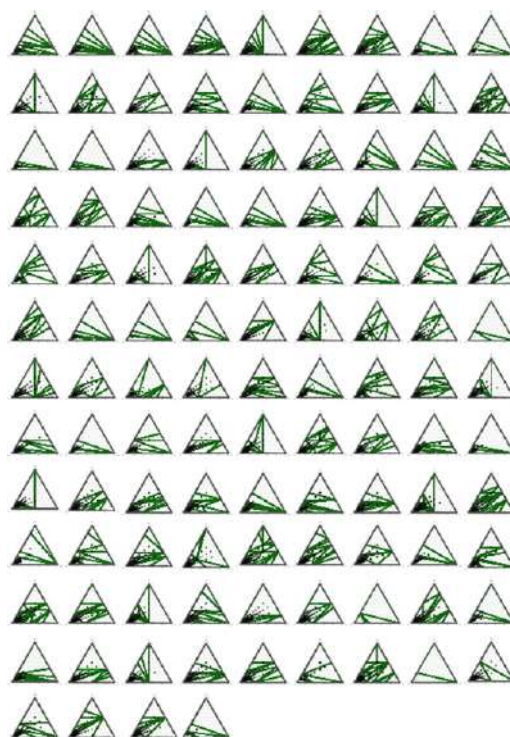

**Figure 17.** An automated high throughput search for selected ternary hydride compositions at 200 GPa. 112 ternary convex hulls are presented for the  $A$ - $B$ - $H$  compositional space:  $A = \{\text{Mg, Y, La, Sr, S, Yb, Th, Ca, Sc, Na, K, Ac, Ba, Zr, Rb, Ce}\}$ ,  $B = \{\text{Li, Be, B, C, N, O, F}\}$ . Saddle-point AIRSS is employed to focus the search on symmetric structures which may be dynamically stabilised. Ternary compounds on or close to the convex hull can then be screened for a suitable electronic structure before the detailed computation of  $T_c$ .

made for the importance of this search, and what level of computational resource that is justified? This roadmap will play an important role in answering these questions.

Taking into account the effects of temperature, and quantum dynamics, on structure is extremely important, but computationally very expensive. It is vital that efficient approaches are developed, which would allow structure prediction to be performed above 0 K, and account for quantum nuclear effects. An approximate approach, which is extremely computationally efficient and can be immediately applied to random structure searches over a range of compositions (see figure 17), is saddle-point AIRSS (sp-AIRSS) [121]. Guided by the observation that dynamical effects always raise the symmetry of a structure, AIRSS computations are performed using a high degree of symmetry, which is maintained during the local optimisation. This means that saddle point structures can be identified, and those that are sufficiently low in enthalpy assessed for dynamical stabilisation in a post processing step. Configurational entropy, which may stabilise sub-stoichiometric or doped systems, is very difficult to treat in general. ML based approaches to approximating the energy landscape, by developing ML potentials, are increasingly being integrated into random structure searches [122] and provide a route to tackling complex disordered supercells, microstructure and long timescale dynamics and kinetically driven transformations.

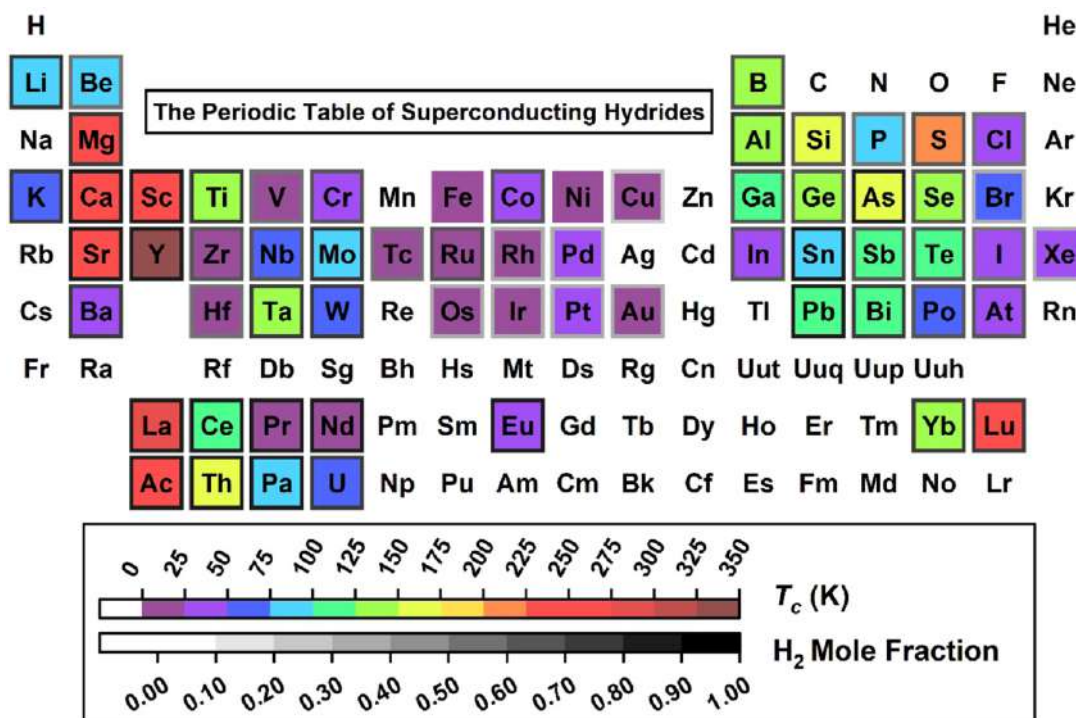

**Figure 18.** The periodic table colored according to the highest  $T_c$  value theoretically predicted for a binary hydride of that element. The color scheme, in Kelvin, is provided in the inset. The  $H_2$  mole fraction in the hydride with the highest  $T_c$  is represented by the color outlining the chemical symbol. Reprinted from [17], with the permission of AIP Publishing.

#### 12.4. Concluding remarks

Ashcroft's dream of high temperature superconductivity in the dense hydrides has been dramatically confirmed. A path, albeit uncertain, has been revealed to the long-held dream of creating materials that will superconduct at well above room temperature, and ambient pressures. This is the 'high road' (see figure 16). But the 'low road', a route to expanding our range of engineerable superconducting materials at liquid nitrogen temperatures, should not be neglected. There are many difficulties faced by the current range of ceramic high temperature superconductors, and providing alternatives will dramatically accelerate technological progress toward, for example, practical fusion power generation. Given sufficient resources, the computational scouring of composition space is achievable. But more efficient computational approaches to the treatment of kinetics, dynamics, and disorder, are desperately needed.

#### Acknowledgments

I thank Alice Shipley and Michael Hutcheon for their careful reading of the manuscript and insightful comments. This work has been funded by the EPSRC over many years (Projects EP/G007489/1 and EP/P022596/1), and through a Royal Society Wolfson Research Merit Award.

### 13. Chemical principles to guide the discovery of evermore complex superconducting hydrides

*Eva Zurek and Tiange Bi*

University at Buffalo, SUNY, United States of America

#### 13.1. Status

The search for high-temperature superconductivity in high-pressure hydrides is a remarkable success story born from synergy between experiment and theory. Ever since Ashcroft predicted that the addition of a second element to hydrogen can decrease its metallization pressure via 'chemical pre-compression' while retaining all of the good properties required for superconductivity [16], first-principles studies employing CSP methods to explore the potential energy landscape [123] have been used to search for the most promising candidates at pressures attainable in DACs. Within a decade, the preferred stoichiometries of most binary hydrides, their emergent structures, and propensity for superconductivity have been studied by theory [124].

Figure 18 illustrates the maximum superconducting critical temperatures,  $T_c$ s, for the binary hydrides estimated under the assumption that they behave as conventional, or BCS, superconductors. Two regions of the periodic table stand out as being the most promising in terms of high  $T_c$  values. The first consists of electropositive alkaline metals or rare earth metals, and the second a handful of p-block elements. Remarkably, members of both classes of superconducting hydrides have been synthesized at around the same time they were studied theoretically, with the first examples being  $H_3S$  ( $T_c = 203$  K near 150 GPa) [6] and  $LaH_{10}$  ( $T_c = 250$ – $260$  K near 200 GPa) [10, 18].

The chemical properties of these two classes of superconducting hydrides turn out to be unique. Electropositive elements do not form covalent bonds with hydrogen or with each other, but rather they donate their electrons to the

hydrogenic sublattice, which can assume a wide variety of structural motifs ranging from atomic, molecular, to periodic [17]. What's more, the superconducting properties are determined by the nature of the hydrogenic motifs. The structures assumed by the p-block hydrides are very different, being dominated by the formation of both homonuclear and heteronuclear covalent bonds. Even though the zero-point motion and nuclear quantum fluctuations affect the stability of these phases, CSP searches within the static-lattice approximation have done a good job of pinpointing regions of chemical space to be further explored by more accurate calculations, and inspired targets for synthesis.

### 13.2. Current and future challenges

The next step is the exploration of the chemical landscape of evermore complex hydrides as a function of composition and pressure. The increased combinatorial possibilities tantalize at the prospect of achieving even higher  $T_c$  values, and finding ways to kinetically trap promising phases to pressures where they may be useful in real-life applications. At the same time, the chemical space becomes dauntingly vast—the 83 elements that are heavier than hydrogen, but are not significantly radioactive, yield 6723 ternary and  $5.5 \times 10^5$  quaternary hydride combinations. Moreover, the stoichiometry can be varied, and metastable species must be considered. With this in mind, chemical concepts need to be developed to guide the choice of elements and their relative proportions.

The results of first-principles based CSP searches are beginning to shape our chemical intuition on the types of structures that may prove to be stable under pressure, and their superconducting properties. Here, we summarize the results for four different classes of ternary hydrides. (i) When multiple electropositive elements are combined with an excess of hydrogen, they tend to form structural motifs similar to those found in the binary hydrides, but there is potential for greater structural variety. For example, the clathrate cage present in the predicted high  $T_c$   $\text{Li}_2\text{MgH}_{16}$  phase differs from those present in any of the binary hydrides [25]. (ii) Combining hydrogen with two p-block elements leads to structural diversity that is composition dependent. Computations have predicted that C–S–H ternaries can exist as molecular crystals, as well as 1 or 2-dimensional p-block lattices whose dangling bonds are capped by hydrogen atoms. Many of these structures adopt classic bonding schemes, and they are unlikely to be good superconductors. Instead, the best superconducting candidates turn out to be derived from the parent binary: various high  $T_c$   $\text{CSH}_7$  phases can be made by removing one set of interpenetrating lattices within  $\text{H}_3\text{S}$  and replacing it by  $\text{CH}_4$  molecules (figures 19(a) and (b)) [125, 126]. (iii) Combining electropositive and p-block elements with hydrogen often yields a stable product where the first two of these elements undergo bond formation, and the resulting lattice is interspersed with  $\text{H}_2$  molecules. Such compounds are not conducive toward superconductivity. However, metastable species related to the parent binaries may be: the superconducting  $\text{CaSH}_3$  phase in figure 19(c) contains 2D sheets with the same type of bonding found in  $\text{H}_3\text{S}$  [127]. (iv) Doping a superconductor can shift the Fermi level so it lies

on a maximum in the density of states, thereby increasing  $T_c$  [128].

### 13.3. Advances in science and technology to meet challenges

Above we summarized some chemical principles discovered by analysing the results of theoretical studies on multi-component hydrides that could limit the search space when designing superconductors in silico. However, because computational studies on ternary and quaternary hydrides are in their infancy, many chemical trends are still unknown. Therefore, theoretical explorations into uncharted chemical territory are of utmost importance to further develop our chemical intuition under pressure. Developing a better understanding of the relationship between metastability and synthesizability, as well as the influence of quantum fluctuations on structural properties and stability will be instrumental in helping theoreticians decide which compounds should be chosen for further scrutiny. Moreover, the discovery of easy-to-compute descriptors for high  $T_c$  will help to focus theoretical efforts. Recent advances in CSP methods have made it possible for researchers to predict the thermodynamically stable, and important metastable phases of multi-component hydrides containing up to  $\sim 125$  atoms [123]. However, future algorithmic advances are required so these methods can be applied concurrently to a wide range of stoichiometries. For example, custom made machine-learned interatomic potentials, which speed up energy evaluations and geometry minimizations, could be used in conjunction with CSP algorithms to generate phase diagrams. Moreover, quickly attainable  $T_c$  descriptors could be combined with thermodynamic quantities to determine fitness in multi-objective optimizations. Finally, automated workflows that can be used to analyze the large amount of data generated in CSP searches are also desired.

### 13.4. Concluding remarks

Less than 20 years after Ashcroft dared to dream about high temperature superconductivity in hydrides compressed to centre-of-the-earth pressures, a number of them have been synthesized and their properties have been measured. Ternaries and quaternaries tempt with the prospect of metastability at lower pressures, but their chemical space is so vast that principles guiding the combinations that should be explored are urgently needed. Though the results of existing theoretical studies provide some chemical intuition, future technological advances are required to fill gaps in our knowledge. Speeding up CSP searches by merging them with custom interatomic potentials would increase the range of stoichiometries that could be explored, and developing superconductivity descriptors would aid in deciding which structures to single out for further analysis. Moreover, the potential for the formation of metastable species, and the synthetic routes that may be used to access them, needs to be better understood.

### Acknowledgments

We acknowledge the National Science Foundation (DMR-1827815) for financial support.

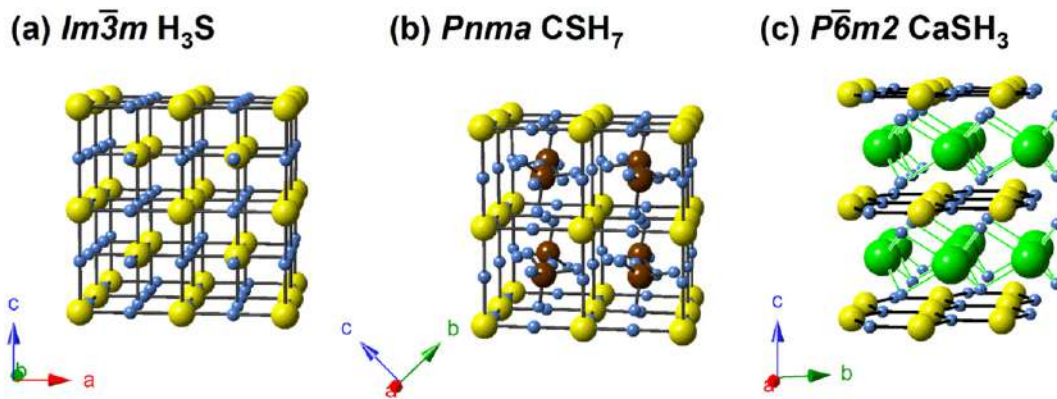

**Figure 19.** Superconducting high-pressure hydride phases that contain H–S lattices: (a)  $\text{H}_3\text{S}$ , (b)  $\text{CSH}_7$ , and (c)  $\text{CaSH}_3$ . Sulfur/hydrogen/carbon/calcium atoms are colored yellow/blue/brown/green. Reprinted with permission from [123]. Copyright (2021) American Chemical Society.

## IV. *Ab initio* theory of superconductivity

### 14. *Ab initio* Eliashberg calculations

Ryotaro Arita

University of Tokyo, Japan  
RIKEN, Japan

#### 14.1. Status

The Eliashberg theory is a many-body perturbation approach to superconductivity [129]. Based on the Green's function formalism, we consider the attractive interaction originating from the electron–phonon coupling and the screened Coulomb repulsion. While the Eliashberg theory provides a fundamental scheme for first-principles calculation of superconductors, its numerical cost is quite expensive. Thus, one has introduced several approximations and simplifications. To evaluate the superconducting transition temperature ( $T_c$ ), McMillan, Allen, and Dynes derived a useful formula with the following three parameters: the logarithmic averaged phonon frequency, the electron–phonon coupling constant, and the pseudo-Coulomb potential. We can evaluate the first two parameters from first principles accurately with a calculation based on density-functional perturbation theory. On the other hand, the pseudo-Coulomb potential is usually treated as an adjustable parameter for which a value of  $\sim 0.1$  is used. This McMillan–Allen–Dynes formula has been used to search for phonon-mediated superconductors having high  $T_c$ 's. Indeed, various high- $T_c$  hydrogen compounds under extremely high pressures have been predicted and discovered. When a new superconductor (such as the iron-based superconductor) is discovered, this formula has been used to discuss whether it is a conventional or unconventional superconductor.

More recently, there have been many developments to solve the Eliashberg equation from first principles [129]. One can now consider the wavenumber-dependence of the electron–phonon interactions and the gap function without taking their averages on the FS [12]. Many methods to treat the retardation effect from first principles have also been developed, where we no longer have to introduce the empirical pseudo

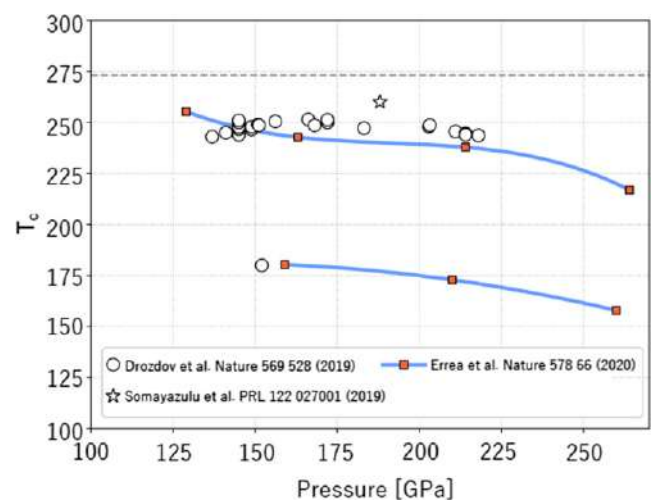

**Figure 20.** Experimental superconducting transition temperature (open circle and star) compared with theoretical values calculated by *ab initio* Eliashberg calculation (solid square).

Coulomb potential [130]. One can even consider the effects of anharmonic phonons and the zero-point motion of atoms, and successfully reproduce the pressure dependence of the experimental  $T_c$  of  $\text{H}_3\text{S}$  and  $\text{LaH}_{10}$  (figure 20) [36].

While the Eliashberg theory was originally formulated for phonon-mediated superconductors, one can extend the scheme to study unconventional superconductors. To design and predict unconventional room-temperature superconductors, extension of the current *ab initio* Eliashberg approach is crucially important.

#### 14.2. Current and future challenges

So far, non-empirical calculation of high-temperature superconductivity has been successfully performed for hydrogen compounds such as  $\text{H}_3\text{S}$  and  $\text{LaH}_{10}$  under high pressure. While most of the predictions have focused on two-element (binary) compounds, researchers are now moving into the uncharted territory of three-element (ternary) hydrides, for which predictions will become harder [129]. Very recently, Snider *et al* reported that a carbonaceous sulfur hydride exhibits room

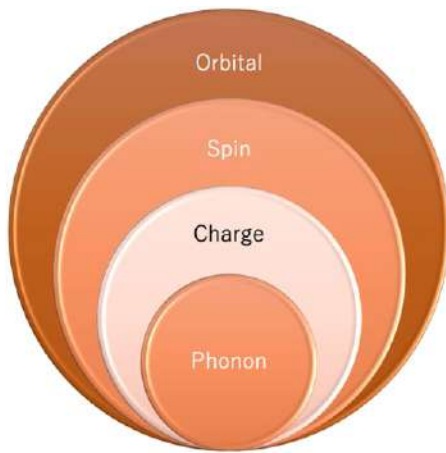

**Figure 21.** Extension of the conventional Eliashberg approach for the phonon mechanism to unconventional mechanism mediated by charge, spin, and orbital fluctuations.

temperature superconductivity ( $T_c \sim 290$  K) [20]. While the crystal structure of this compound is yet to be clarified, *ab initio* Eliashberg calculation suggests that  $T_c$  in carbon doped  $H_3S$  is not as high as 290 K [131].

Another significant research challenge is developing a new *ab initio* Eliashberg approach for unconventional superconductors mediated by a variety of bosons other than phonon. As for charge fluctuations, the plasmon mechanism has been studied extensively. By considering the frequency dependence of the screened Coulomb interaction, it has been shown that  $T_c$  can be dramatically enhanced [132]. The role of low energy plasmon is of great interest since it gives strong electron–plasmon coupling. Higher plasmon energy, i.e., on the electronic energy scale (which is normally the case) leads to a breakdown of Migdal’s theorem, and the exploration of the next-order diagrams is of great fundamental importance in the context of the current state of the art Eliashberg theory of superconductivity. Another intriguing possibility is the exciton mechanism, for which the interplay with phonon is an issue of a long history.

First-principles calculation for spin-fluctuation-mediated superconductivity is also a big challenge. Recently, active efforts have been made to describe superconductivity in iron-based superconductors [133]. For iron-based superconductors, there has been a theoretical proposal that not only spin fluctuations but also orbital fluctuations play a crucial role [134]. Thus, another big research issue is to develop *ab initio* methods for orbital-fluctuation-mediated superconductivity (figure 21).

The problem becomes further challenging when the normal metallic phase associated with the superconducting transition is not a simple Fermi liquid. For example, an *ab initio* description of superconductivity near the Mott insulating phase is very difficult. In this case, the normal metallic phase cannot be described by the conventional approach, such as the local density approximation. One possible approach is to combine first-principles calculation with non-perturbative many-body methods. There, we often derive a low-energy effective model

from first principles [135]. However, it is another highly non-trivial problem to derive such an effective model without ambiguity, especially when the low-energy bands are heavily entangled with high energy bands.

#### 14.3. Advances in science and technology to meet challenges

Regarding *ab initio* prediction of RTSC in hydrogen compounds, theorists must figure out how to retain their high  $T_c$ ’s at lower pressures or ambient pressure. To achieve this ultimate goal, it is critically important to investigate materials with more than three elements. For such materials, there will be a huge number of possible structures, and the number of ways that each material can decompose will be greater. Recent developments in the structure prediction methods will help to overcome this problem.

Another problem of *ab initio* calculation for hydrogen compounds is that its numerical cost is generally very expensive. Many hydrides having high  $T_c$  have a zeolite-like cage structure, whose unit cell generally contains many atoms. Progress in the development of numerical techniques reducing the size of matrices in the Eliashberg equation will make the calculation more efficient.

Recently, based on the Eliashberg calculation, a new exchange correlation functional for density functional theory for superconductors (SCDFT) has been constructed (see the section by Sanna and Gross). While the numerical cost of SCDFT is generally less expensive than that of *ab initio* Eliashberg approach, the progress in the *ab initio* Eliashberg method will certainly lead to further progress in SCDFT.

To investigate the possibility of unconventional RTSC, we need to go beyond the present *ab initio* Eliashberg approach and formulate a non-perturbative scheme. In this direction, the ultimate goal is to establish an unbiased method that does not depend on any *a priori* assumption on the pairing mechanism. Recently, various non-perturbative methods have been compared and examined in a systematic and exhaustive way for the single-orbital Hubbard model [136]. It is true that electronic structure of real materials is generally more complicated and the numerical cost will be formidably expensive than the Hubbard model. However, studies for simple models will provide a firm ground to develop non-perturbative methods for realistic models.

#### 14.4. Concluding remarks

The *ab initio* Eliashberg studies have made a great success for conventional superconductors, especially for predicting high- $T_c$  superconductivity in hydrogen compounds under high pressure. Although there is still a problem of computational cost for systems with a large unit cell and compounds containing more than three elements, the recent development of numerical methods is expected to overcome this problem. The next significant challenge will be an *ab initio* prediction of RTSC mediated by unconventional mechanisms. To achieve this ultimate goal, developing non-perturbative and unbiased methods going beyond the standard Eliashberg approach is crucially important.

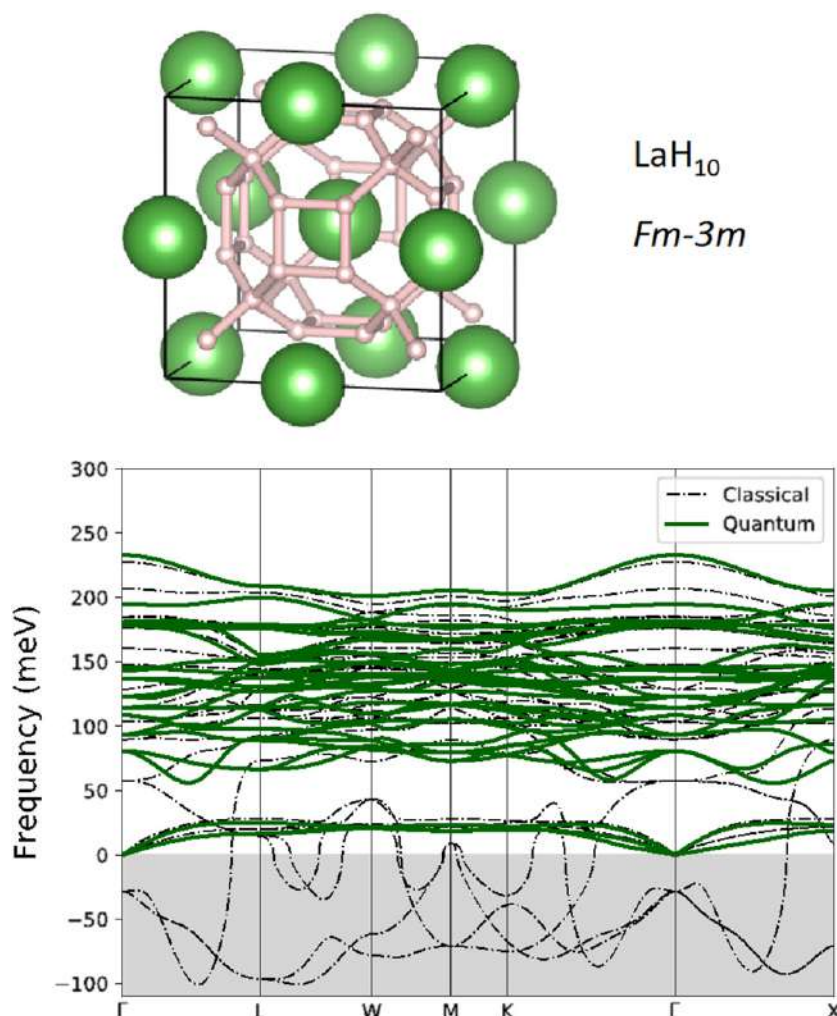

**Figure 22.** Crystal structure stabilized by quantum effects of the high-temperature superconductor  $\text{LaH}_{10}$ . In the bottom panel the phonon frequencies of this structure at 129 GPa calculated classically from the Hessian of the Born–Oppenheimer potential (harmonic approximation) and from the Hessian of the quantum energy, which includes anharmonic terms of the potential. Negative values represent imaginary phonon frequencies, meaning that the system is unstable for that mode. While the structure is unstable classically, quantum effects stabilize it. Data taken from reference [36].

## Acknowledgments

The author acknowledges the financial support by JSPS KAKENHI Grant No. 19H05825.

## 15. High-temperature hydrogen-based superconductors: a quantum energy landscape

*Ion Errea*

University of the Basque Country (UPV/EHU), Spain

### 15.1. Status

Room temperature superconductivity is already a reality thanks to the recent discovery of a carbonaceous sulfur hydride with a critical temperature ( $T_c$ ) as high as 288 K [20]. This possibility had been anticipated by the 2015 revolutionary discovery of a superconducting state at 203 K for  $\text{H}_3\text{S}$  [137], as well as the  $T_c$  of around 250 K observed later in  $\text{LaH}_{10}$  [10, 18].

It is an experimental fact now that hydrogen-based compounds can be high-temperature superconductors, a statement not generally accepted few years ago. All of these are compounds, however, that require pressures above 100 GPa to be synthesized and reach such outstanding superconducting properties. The challenge for the next decade is to reduce their synthesis pressures. The roadmap thus is not really about designing room temperature superconductors, but about designing room temperature and ambient pressure superconductors.

Theoretical *ab initio* calculations will be crucial in this route. In fact, both  $\text{H}_3\text{S}$  and  $\text{LaH}_{10}$  had been predicted to be good superconductors before their experimental discovery by making use of CSPs and calculations of the electron–phonon coupling [5, 79]. The combination of *ab initio* CSP methods with first principles  $T_c$  calculations based on the electron–phonon interaction will continue guiding experimental work into fantastic discoveries in the future, also at lower pressures [118]. However, first principles techniques need to be further developed in the near future in order to boost discoveries,



as currently they have difficulties dealing with the quantum nature of the ions, which turns out to be crucial in the understanding of the structural and superconducting properties of both  $\text{H}_3\text{S}$  and  $\text{LaH}_{10}$  [36, 138]. This is not surprising due to the lightness of hydrogen, but also, as it will be stressed below, due to the large electron–phonon interaction present in these compounds.

### 15.2. Current and future challenges

The crystal structure that yields the highest critical temperature for  $\text{H}_3\text{S}$  and  $\text{LaH}_{10}$  is stabilized by the large quantum fluctuations of the hydrogen atoms [36, 138]. If atoms were classical particles, these structures would not be the ground state as shown in figure 22. The case of  $\text{LaH}_{10}$  is paradigmatic as quantum effects stabilize the high- $T_c$  and high-symmetry  $Fm\bar{3}m$  structure in a wide pressure range, decreasing the classical instability pressure by more than 100 GPa [36]. This means that the energy landscape in which these high- $T_c$  superconductors lay is quantum, and very different from the classical Born–Oppenheimer energy surface (BOES). In other words, the minima of the quantum energy landscape are different from those of the BOES. Consequently, the structural, vibrational, and superconducting properties of these compounds are determined by the full anharmonic shape of the BOES, not by its lowest-order harmonic expansion around its minimum.

This poses big challenges to the first-principles calculations of  $T_c$  in these superconductors. First, because the ground state structure needs to be determined by considering the full quantum energy landscape. Second, because, as a consequence, phonon energies are subject to huge anharmonic corrections. And third, because the large ionic fluctuations may also affect the electron–phonon interaction, for instance, questioning the standard linear approximation. The first two points can now be addressed rather efficiently, though at a high computational cost, with variational methods that can relax crystal structures in the quantum energy landscape and provide renormalized phonon frequencies [36, 138]. Whether non-linear effects in the electron–phonon coupling, i.e. renormalization of the electron–phonon interaction vertices due to non-linear ionic fluctuations, are important requires still further work, also from a methodological point of view.

Large ionic fluctuations can thus largely affect the calculation of  $T_c$ . However, the calculation of  $T_c$  requires also a theory of superconductivity. Solving anisotropic Migdal–Eliashberg equations with explicit *ab initio* calculations of the Coulomb matrix elements seems the most accurate approach at the moment [36]. This is true only once the above-mentioned fluctuation effects are incorporated, at least, to the crystal structure and the phonon frequencies. In fact, the most advanced superconducting theory applied to the BOES-minimum structure will inevitably fail if the true ground state is significantly different.

### 15.3. Advances in science and technology to meet challenges

The main challenge to discover new high- $T_c$  superconductors at low pressures is to perform crystal structure searches but not in the classical BOES as it has been done up to date, but in the quantum energy landscape. In principle, all the necessary techniques are there, as we have several crystal structure codes available to the community as well as variational methods, such as the stochastic self-consistent harmonic approximation, to calculate free energies fully including the quantum nature of the ions. However, a blind application of CSPs with quantum and anharmonic free energies is out of the question: the number of crystal structures to be relaxed in the quantum landscape would be simply too many for an *ab initio* approach. A simple valid alternative would be to start quantum relaxations only for the most competitive structures found classically. This was the approach recently followed for  $\text{LaH}_{10}$  [36]. Another alternative, which might emerge in the next years, could be based on new machine-learning interatomic potentials. These potentials could be trained on the classical crystal structure calculations and used *a posteriori* for the quantum structural relaxations. Obviously, these approaches will be successful if these potentials are transferable and accurate enough.

The understanding of the effects of ionic fluctuations on the electron–phonon matrix elements themselves, beyond the crystal structure and the phonon energies, is also a question to be answered in the next years. Although it does not need to be necessarily true, it seems reasonable to expect that a system largely affected by anharmonic effects on its phonon frequencies will also suffer from non-linear effects on the electron–phonon interactions: the simple linear expansion of the wave function around the reference position may not be sufficient. Thus far these effects have been neglected, as the electron–phonon interaction has been calculated including anharmonic corrections on the phonon frequencies and polarization vectors, but assuming a linear change of the potential with respect to ionic displacements. It is true, however, that linear calculations have been predictive in many of these hydrogen-based compounds. New techniques that will be developed in the next years will clarify the relevance of these non-linear effects on the calculations of  $T_c$ .

### 15.4. Concluding remarks

It has been recently remarked [36] that the classical harmonic instabilities of hydrogen-based high- $T_c$  compounds may be related to their huge electron–phonon interaction. In fact, it has been long argued that a large electron–phonon interaction can induce instabilities in the classical harmonic approximation [139]. These instabilities yield transitions to lower symmetry structures that reduce the density of states at the Fermi level, reducing consequently  $T_c$ . Quantum fluctuations are able to overcome these instabilities and keep these

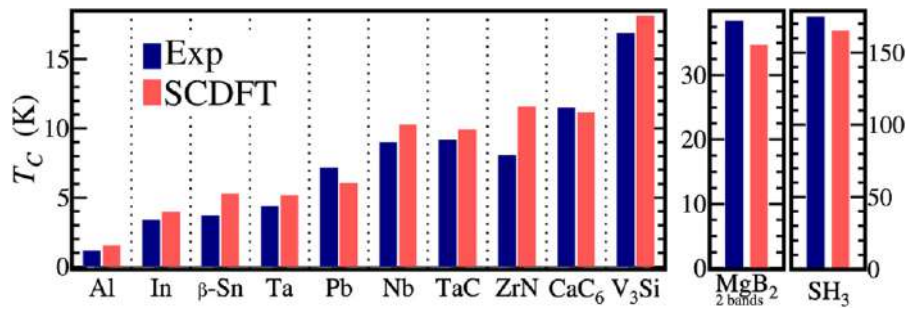

**Figure 23.** SCDFT predicted critical temperatures for a set of conventional electron phonon superconductors and comparison with experimental values. Details can be found in reference [142].

high- $T_c$  structures thermodynamically stable at much lower pressures. Therefore, if we were able to perform crystal structure searches in the quantum energy landscape, we would probably find new high- $T_c$  compounds at much lower pressures and put experimental colleagues on the right track for finally reaching high-temperature and ambient pressure superconductivity.

### Acknowledgments

This research was supported by the European Research Council (ERC) under the European Union's Horizon 2020 Research and Innovation Program (Grant Agreement No. 802533).

## 16. Extending the predictive power of DFT for superconductors: toward nonadiabatic electron–phonon coupling

Camilla Pellegrini<sup>1</sup>, Antonio Sanna<sup>2</sup>, Ryan Requist<sup>2</sup> and E K U Gross<sup>2</sup>

<sup>1</sup>Hebrew University of Jerusalem, Israel

<sup>2</sup>Max'Planck of Microstructure Physics, Halle Germany

### 16.1. Status

Over the past 30 years DFT has enjoyed enormous popularity as an accurate yet computationally feasible method for the *ab initio* calculation of normal-state electronic properties. The discovery of high-temperature superconductors motivated an extension of DFT to superconductivity in order to predict properties such as the superconducting critical temperature ( $T_c$ ) and the gap at zero temperature [140]. Within SCDFT, a superconducting material is fully described in terms of two quantities: the ordinary electron density and the superconducting order parameter. This additional density is determined by solving a BCS-like gap equation, where the screened Coulomb repulsion and the phonon-mediated attraction between the electrons are incorporated via the xc potentials, which are universal functionals of the two densities. Compared to traditional many-body Eliashberg theory, SCDFT yields two major advantages: the numerical simplicity of the gap equation, and the absence of any empirical parameter like the Coulomb pseudopotential.

The basic Hohenberg–Kohn and Kohn–Sham theorems of SCDFT were proved by Oliveira, Gross and Kohn in

the late 1980s. A first approximation to the xc functionals was derived on the basis of many-body perturbation theory by employing the optimized effective potential method in the exchange-only approximation [141]. However, in addition to neglecting vertex corrections, as justified by Migdal's theorem, the phononic part of the functional also neglected the dressing of the electronic Green's function, which made it of questionable accuracy for treating phonon-mediated superconductivity. Recently, a new functional that retains the accuracy of Migdal's approximation has been derived from the parametrization of the Eliashberg self-energy for a simple Einstein phonon spectrum [142]. This functional has enabled accurate density functional calculations of experimental superconducting gaps without resorting to expensive GW calculations. For all the materials tested so far, the  $T_c$ 's and gaps predicted by the new functional turn out to be in excellent agreement with the experimental data, while the numerical effort is significantly lower than solving the full Eliashberg equations (figure 23).

### 16.2. Current and future challenges

SCDFT is presently a powerful tool, but its predictive power is limited to conventional phonon-driven superconductors. Although this proves sufficient to describe room temperature superconductivity in the high pressure regime, at atmospheric pressure pairing mechanisms of purely electronic origin are believed to be essential for achieving high  $T_c$  ( $\gg 100$  K).

One mechanism of utmost importance is the spin-fluctuation mechanism, which is commonly assumed to be responsible for high- $T_c$  superconductivity in Fe and Cu based superconductors [143, 144]. Electronic charge fluctuations, including plasmons [145] and orbital fluctuations [144], may also favor superconductivity by providing additional contributions to the attractive pairing. Along these lines there has already been some progress in the construction of a plasmonic xc kernel [145] and a preliminary functional approximation including spin-fluctuations [143].

Even though, despite many years of systematic theoretical search, no phononic superconductor with  $T_c > 39$  K has been found, there might be situations in which the electron–phonon coupling leads to superconductivity beyond the predictive capability of conventional theory. One aspect that has been long overlooked, especially in SCDFT, is the role of nonadiabatic effects in the dynamics of electrons and

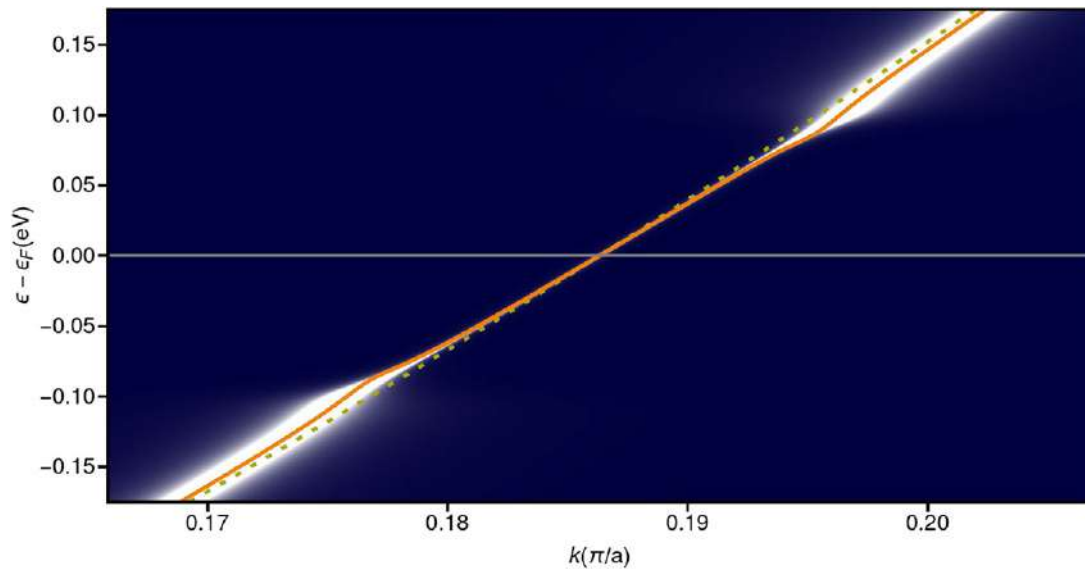

**Figure 24.** The Kohn–Sham band structure (orange) in exact factorization-based DFT captures the phonon-induced wiggle in the electronic spectral function (background blue-white color scale) of the Fröhlich model with a parabolic electronic band (dashed yellow) linearly coupled to a single Einstein phonon with energy 0.1 eV.

phonons. There is indeed experimental evidence that a number of phononic superconductors are not described by the conventional many-body theory of superconductivity based on Migdal’s theorem, which breaks down when the energies of electrons and phonons are comparable. In this regard, a generalization of the functional construction scheme [142] within SCDFT, by effectively including vertex corrections to the electron–phonon self-energy, seems to be particularly appealing. Evaluating these higher order contributions in a direct many-body approach is in fact extremely costly due to cumbersome Matsubara frequency summations. On the other hand, in SCDFT these sums can be integrated analytically by following a procedure similar to that used in reference [142].

However, this approach would only involve the electronic degrees of freedom and is expected to increase the superconducting  $T_c$  for low Fermi velocity [146]. Nevertheless, nonadiabatic corrections could also significantly affect the electron phonon coupling strength and the lattice dynamics, either stabilizing or suppressing the superconducting phase, depending on the material properties. A way to systematically include nonadiabatic electron–phonon effects would be to use a DFT/many-body formalism which does not depend on the Born–Oppenheimer (BO) approximation.

### 16.3. Advances in science and technology to meet challenges

Standard DFT relies, by its very nature, on the BO approximation: the ground-state density is calculated from the electrostatic potential of clamped nuclei. Since first-principles calculations of electron–phonon coupling (used, e.g., in SCDFT and Eliashberg theory [147]) start from DFT calculations of the electronic structure, the BO approximation is implicitly assumed. Recently, a generalized DFT framework for the treatment of electrons and phonons has been developed [148] starting from the exact factorization of the electron–nuclear wave

function into electronic and nuclear components [149]. The basic electronic variable is the exact (rather than BO) electronic density, which depends parametrically on the set of nuclear coordinates. The equations to be solved are generalized KS equations with a nonadiabatic Hartree xc potential and a nuclear Schrödinger equation with a beyond-BO PES. Exact phonons are defined by the harmonic expansion of the latter equation. Results for the Fröhlich model show that already the simplest approximation, in which nonadiabatic contributions to the PES are added to standard BO-DFT functionals like LDA or GGA, can reproduce the leading-order phonon-induced band structure renormalization, including the renormalization of the Fermi velocity (see figure 24).

Extending exact factorization-based DFT to superconductivity would establish a beyond-BO SCDFT which would allow for (i) a seamless description of electron–phonon effects in the normal state and (ii) the inclusion of nonadiabatic effects on the superconducting side. The latter effects might be relevant for systems like molecular superconductors or doped insulators such as  $\text{Cs}_3\text{C}_{60}$ ,  $\text{BaK}_x\text{BiO}_3$  and BEDT-TTF.

An alternative way of capturing non-adiabaticity in the superconducting state would be to set up a connection to the recent many-body Green’s function theory beyond the BO approximation proposed in reference [150]. A first SCDFT nonadiabatic functional could be derived starting with the Eliashberg (GW) self-energy diagram, where standard Green’s functions are replaced by nonadiabatic propagators [150], and then following a similar procedure as in reference [142].

### 16.4. Concluding remarks

SCDFT has attained a level of maturity where it allows for accurate and computationally efficient calculations of  $T_c$ ’s and gap functions of phononic superconductors. However, superconductors displaying strong nonadiabatic effects, as well as

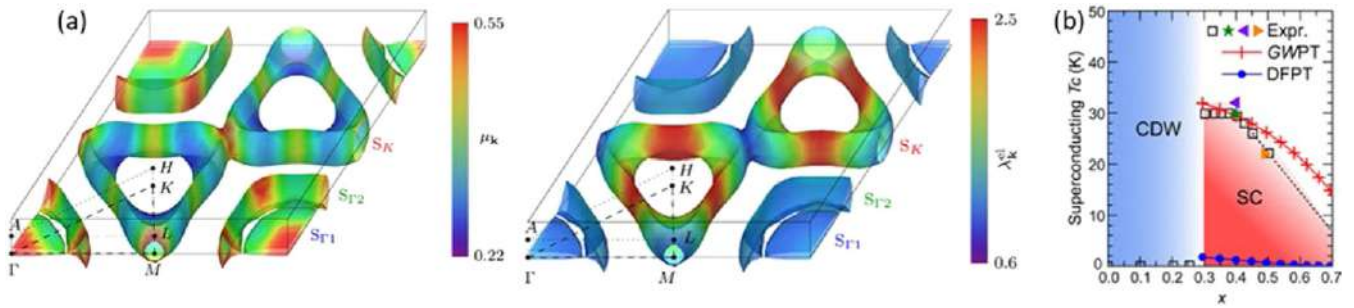

**Figure 25.** Momentum resolved screened Coulomb interaction and e–ph interaction strength on the FS of 2H-NbS<sub>2</sub>. Reprinted figure with permission from [155], Copyright (2017) by the American Physical Society. (b) Superconducting phase diagram of Ba<sub>1–x</sub>K<sub>x</sub>BiO<sub>3</sub>. Calculated  $T_c$  with  $\mu^* = 0.16$  are plotted as red crosses for GWPT and blue dots for DFPT. Experimental data are plotted as squares, star, left-pointing triangle, and right-pointing triangle. Reprinted figure with permission from [158], Copyright (2019) by the American Physical Society.

unconventional pairing, are presently out of reach. In our opinion, these materials are the most promising candidates for achieving high-temperature superconductivity at ambient pressure as they belong to a largely unexplored basin of search. Future developments of SCDFT should thus aim at their description. With regard to nonadiabatic effects we propose that SCDFT, as well as the conventional theory of superconductivity, may benefit from a change in paradigm where the starting point is a unified treatment of electrons and nuclei based on the exact-factorization approach.

## Acknowledgments

We acknowledge financial support by the European Research Council Advanced Grant FACT (ERC-2017-AdG-788890). AS acknowledges hospitality of the Physics Department of La Sapienza, under the program ‘Professori Visitatori 2020’.

## 17. Modeling superconducting properties with the Eliashberg formalism

*Elena Roxana Margine*

Binghamton University-SUNY, United States of America

### 17.1. Status

Advances in electronic structure methods alongside developments in software packages and computing hardware have made it possible to model a host of complex materials properties from first principles. In particular, the research in conventional superconductivity has come a long way from making rough estimates of the critical temperature ( $T_c$ ) to probing pairing mechanisms and resolving superconducting energy gaps. Nevertheless, fully *ab initio* prediction of superconducting properties remains challenging, and the vast majority of investigations rely on the semi-empirical McMillan or Allen–Dynes formulas for estimations of the critical temperature.

A major part of the success achieved in the characterization of the superconducting state in materials with conventional pairing can be attributed to the development of the

many-body Eliashberg theory [151], a generalization of the Bardeen–Cooper–Schrieffer microscopic theory of superconductivity. This state-of-the-art theoretical method rests on the Green’s function formalism and gives direct access to the frequency-dependent superconducting energy gap as a solution to a set of self-consistent coupled diagrammatic equations for the electronic and phononic propagators. The approach has been particularly useful for solving Eliashberg equations in the anisotropic, i.e. band and crystal momentum-dependent, form. With the capability of naturally resolving multiple gaps on the FS, it has been used to analyze the two-gap structure in MgB<sub>2</sub> [151] and other intriguing superconductors.

The accurate anisotropic description is achievable only with extremely dense electron and phonon meshes to properly sample the electron–phonon (e–ph) scattering processes in the vicinity of the FS. The development of a first-principles interpolation technique based on Wannier functions was instrumental for overcoming this computational challenge [152]. The approach takes advantage of the spatial localization of the e–ph matrix elements in the Wannier basis and enables their efficient interpolation from a given uniform coarse grid to a desired arbitrary dense Brillouin zone (BZ) grid at a significantly reduced computational cost. So far, the only open-source implementation of the anisotropic Eliashberg formalism with Wannier-based interpolation is available in the EPW code [153] (<https://epw-code.org/>) distributed as part of the Quantum ESPRESSO package (<https://github.com/QEF/q-e/releases>). A numerical procedure based on symmetric Helmholtz Fermi-surface harmonics (HFSH) has also been proposed as a robust approach to treat the anisotropy of the e–ph interaction in the Eliashberg equations [154]. The basic idea is to replace BZ integrals in the  $k$  space with inexpensive sums over a few HFSH coefficients.

While these advances have enabled accurate modeling of the e–ph anisotropy from first principles, the Coulomb correlations effects in the Eliashberg equations are still treated predominantly with a single empirical parameter  $\mu^*$  that acts only near the Fermi level. A description of the e–ph and electron–electron (e–e) interactions on an equal footing will

provide insight into the nature of the superconducting state in different classes of materials.

### 17.2. Current and future challenges

Achieving better quantitative agreement with experiments requires a number of theoretical and computational challenges to be addressed.

*Ab initio treatment of the Coulomb interaction.* The semi-empirical treatment of the e–e interaction, while adequate for elemental metals and systems with strong e–ph coupling, breaks down in doped semiconductors, oxides, semimetals, and low-dimensional systems. A more comprehensive evaluation of the Coulomb repulsion has been carried out in several recent studies but only within simplified versions of the Eliashberg formalism, which involves incorporating either double or single FS-averaged screened Coulomb interactions evaluated within the random-phase approximation [36, 155, 156]. However, a fully *ab initio* e–e treatment in the anisotropic framework is essential when investigating superconducting materials with reduced dimensionality and/or with multi-sheet FSs. As an illustration, figure 25(a) shows that in 2H–NbS<sub>2</sub> superconductor both the momentum-resolved e–e and e–ph interactions are highly anisotropic and exhibit hot spots on different FS sheets [155]. Accounting for the Coulomb effects in the anisotropic Eliashberg equations comes with a significant increase in the computational workload. For instance, considering the frequency dependence of the screened Coulomb interaction leads to a long-range behavior in real space that will require special care to converge with the Wannier based interpolation scheme. In addition, due to the high energy scale of the e–e interaction, a larger number of Wannier functions will be necessary to cover this energy range. Finally, the summation over the Matsubara frequencies now needs to extend to energies of tens to hundreds of eV.

*Inclusion of non-adiabatic and other effects.* The validity of the adiabatic approximation in the Eliashberg theory has been questioned for several systems with small Fermi energies, such as the recently discovered high- $T_c$  H<sub>3</sub>S and magic-angle twisted bilayer graphene superconductors. To date, however, the importance of vertex corrections beyond the Migdal approximation has only been assessed in a few studies that have solved the non-adiabatic Eliashberg equations under certain approximations. Solving the anisotropic Eliashberg equations in the non-adiabatic regime adds a new level of computational complexity due to the presence of double summations over each set of electronic bands, crystal momenta, and Matsubara frequencies [157]. Anharmonic lattice instabilities, zero-point and phonon renormalization corrections, plasmonic and polaronic effects, and spin fluctuations are other key contributions that can be instrumental when investigating pairing mechanisms in many classes of superconductors and are generally not accounted for when solving the Eliashberg equations.

*Improvement of computational efficiency.* Superconductivity calculations today are typically limited to systems with no more than 10–20 atoms. The high computational cost prevents the study of superconducting properties in systems

with chemical disorder, two-dimensional materials on substrates, and complex heterostructures, where the e–e and e–ph interactions can be strongly affected by defects, dopants, or interfaces.

### 17.3. Advances in science and technology to meet challenges

Going beyond the standard implementation of the Eliashberg formalism has the potential to dramatically expand the capability and efficiency of the existing methodology for modeling superconducting properties.

First steps have been taken to embed static and dynamic Coulomb effects, and non-adiabatic corrections in the Eliashberg framework [36, 132, 155–157]. Progress has been made to resolve the slow convergence in expensive summations over Matsubara frequencies by adopting sparse sampling algorithms. Implementation of these advanced methods in open-source packages will help understand the importance of the effects in emerging materials classes.

Another impactful research direction concerns addressing the shortcoming of the current DFT-based methods that cannot properly describe quasiparticle energies, vibrational frequencies, and e–ph interactions in strongly correlated systems. For instance, standard DFT approximations have been found to systematically underestimate the e–ph matrix elements in superconducting oxides, such as Ba<sub>1–x</sub>K<sub>x</sub>BiO<sub>3</sub> [158]. The recently developed GW perturbation theory (GWPT) implemented in the open-source BerkeleyGW code (<https://berkeleygw.org/>) improves the description of the e–ph interactions by incorporating the first-order change of the GW self-energy to a phonon perturbation. The GWPT method has successfully explained the doping dependence of the critical temperature observed experimentally in the case of Ba<sub>1–x</sub>K<sub>x</sub>BiO<sub>3</sub>, as shown in figure 25(b) [158]. Combining the GWPT approach with the Eliashberg formalism could considerably improve the predictive power of *ab initio* calculations of conventional superconductivity.

### 17.4. Concluding remarks

Modeling superconducting properties has been long considered one of the most challenging problems in materials research. Recent advances in computational methodology based on the Eliashberg formalism represent an important milestone in moving to fully *ab initio* description of superconductors. Looking forward, the method development work should be complemented with a concerted effort to deploy efficient open-source software packages easily accessible to the scientific community. This will provide opportunities for a systematic exploration of new materials classes and pave the way for theory-guided experimental discoveries of new superconductors.

### Acknowledgments

ERM acknowledges support from the National Science Foundation (Award No. OAC-1740263).

## V. Artificial intelligence applied to superconductor research

### 18. Toward high-throughput superconductor discovery via machine learning

Stephen R Xie<sup>1,2</sup>, Yundi Quan<sup>1,2</sup>, Ajinkya Hire<sup>1,2</sup>,  
Laura Fanfarillo<sup>3,4</sup>, G R Stewart<sup>3</sup>, J J Hamlin<sup>1,2</sup> and  
Peter Hirschfeld<sup>3</sup>

<sup>1</sup>Department of Materials Science and Engineering, United States of America

<sup>2</sup>Quantum Theory Project, United States of America

<sup>3</sup>Department of Physics, University of Florida, Gainesville, Florida 32611, United States of America

<sup>4</sup>Scuola Internazionale Superiore di Studi Avanzati (SISSA), via Bonomea 265, 34136 Trieste, Italy

#### 18.1. Status

Even though superconductivity has been studied intensively for more than a century, the vast majority of superconductivity research today is carried out in nearly the same manner as decades ago. That is, each study tends to focus on only a single material or small subset of materials, and discoveries are made more or less serendipitously. Recent increases in computing power, novel ML algorithms, and improved experimental capabilities offer new opportunities to revolutionize superconductor discovery. These will enable the rapid prediction of structures and properties of novel materials in an automated, high-throughput fashion and the efficient experimental testing of these predictions.

High-throughput approaches to materials discovery have been successful in situations where a well-defined figure of merit depends directly on simple descriptors available in large databases, e.g., thermoelectric coefficients [159]. Unlike such quantities, the critical temperature  $T_c$  of a superconductor depends sensitively on several derived quantities of the coupled electron and phonon systems that are not always well known. Even within the approximate Eliashberg theory of electron–phonon superconductivity, for example, the material-specific Eliashberg function  $\alpha^2F(k, k', \omega)$  is in principle a function of energy and momentum. While  $\alpha^2F$  can be calculated with increasingly high accuracy, the process is still computationally expensive and therefore unsuitable for high-throughput approaches. At the same time, ML techniques have improved dramatically, so that one can imagine learning  $T_c$  from a simpler discrete set of DFT based descriptors that parametrize the Eliashberg function and even learn corrections to the Eliashberg theory. At present, Eliashberg codes are quite sophisticated but do not, in general, include corrections due to spin fluctuations from d- and f-electrons, which can suppress conventional superconductivity or enhance unconventional superconductivity. The recent discovery of near-room temperature superconductivity in high-pressure phases of hydrides by following computational structure predictions illustrates the need for ML approaches to accelerate the exploration of the energy landscape of multinary materials. Combining these various concepts, ML methods have the potential

to improve the prediction of new superconducting materials dramatically.

For decades, the AD formula, an expression for the  $T_c$  of an electron–phonon mediated superconductor, expressed in terms of the moments of the Eliashberg function  $\alpha^2F$  that can be extracted from tunneling experiments, has played an essential role in guiding the search for new superconductors [2]. The AD formula was based on solutions to the Eliashberg equations for a few simple models and materials and is known to deviate strongly from empirical  $T_c$ 's for high-temperature superconductors, e.g., hydrides. In a proof of principle approach, we used the SISSO analytical ML approach to improve on the AD formula, training on the tiny AD dataset of 29 superconducting materials and testing with newer superconducting materials [160]. Clearly, a reliable approach requires a much larger database to learn on, as discussed below.

The search for phonon-mediated high-temperature superconductors rests on a simple principle, i.e., maximizing the electron–phonon coupling strength and the phonon frequencies. Ashcroft proposed [41] dense metallic hydrogen as a candidate for high-temperature superconductivity by noting its high Debye temperature and moderate electron–phonon coupling strength. Nearly half a century after Ashcroft's initial prediction, the hydrogen-rich  $H_3S$ , rather than pure hydrogen, was found to superconduct at around 200 K under megabar pressures [6].

ML has the potential to accelerate the discovery of novel superconductors, like  $H_3S$ , by reducing the computational cost of obtaining  $T_c$  from first-principles calculations and narrowing down the list of candidate materials. Using data from the SuperCon database [161], Stanev *et al* carried out ML studies to establish connections between the superconducting transition temperatures and atomic properties [162]. They discovered several properties that correlate with the superconducting transition temperatures and predicted a host of compounds as possible high-temperature superconductors. Hutcheon *et al* constructed neural network models to predict superconductors with high  $T_c$  under lower pressure than required for superhydrides thus far [163]. Discovering novel materials by ML methods, both with and without coupling to first-principles calculations, is progressing rapidly.

For a given material's system, once thermodynamically stable and metastable crystal structures at various conditions are known, their physical properties, including superconductivity, can be estimated and used to guide the experimental investigations of these materials. Many techniques and codes are available for predicting potentially stable phases and structural transitions, such as the semi-local methods of minima hopping, basin hopping, and simulated annealing and the global methods of genetic algorithms and particle swarm optimization. Chemical intuition, structure–chemistry correlations, and data mining of open-access materials databases can also be used to provide starting structures to these methods. In our work, we have utilized the genetic algorithm for structure and phase prediction (GASP) package [164] for exploring possible structural transitions to clathrate-like structures at high pressures in materials containing light elements. While searching for

potential stable crystal structures at high pressures, it is essential to also consider the stability of the competing phases that might destabilize the stoichiometry of the material of interest. To this end, the GASP package can perform grand canonical searches, meaning it can search for stable crystal structures over the entire composition range of interest and generate a high-pressure convex hull diagram.

While the discovery of the high-pressure superconducting hydrides has revolutionized the field of electron–phonon superconductivity scientifically, it is of little practical utility unless methods can be found to engineer materials at high pressure that remain metastable under ambient conditions. One approach has been to search for hydrides that are superconductors at lower pressures [165]. However, the route to ambient pressure high- $T_c$  materials along this path is far from clear. One promising approach to ambient pressure superconductors that may be used to make large scale films is non-equilibrium growth of metastable materials on solid substrates by methods such as molecular beam epitaxy or chemical vapor deposition, potentially assisted by laser heating. Employing high-energy pre-mixed amorphous starting materials to reach structures and compositions that are inaccessible by just compressing ambient-pressure crystal structures could provide synthesis routes to novel high-pressure phases that remain metastable at ambient conditions. Theory can assist by predicting and characterizing metastable crystal structures to guide the choice of atomic constituents and estimate barriers to the equilibrium phase.

### 18.2. Current and future challenges

ML and high-throughput methods work best when applied to large datasets. Given the improvement of first-principles based predictions of  $T_c$  for electron–phonon based superconductors in recent years, one could imagine constructing a database to enable ML of higher- $T_c$  superconductors by calculating  $\alpha^2F$  and associated moments, e.g., for all 16414 materials in the SuperCon database. However, such a program is prohibitively expensive since each  $\alpha^2F$  calculation typically requires O(100–1000) core-hours of computing time even for elemental superconductors with a modern package such as Quantum Espresso. Purely electronic descriptors like the Fermi level density of states,  $N(0)$ , are much cheaper and can enable extensions of ML approaches such as that attempted by Stanev *et al* [162]. The challenge, in this case, is to identify which purely electronic descriptors are important for high- $T_c$ . We are constructing a high-throughput scheme along these lines.

Any high-throughput approach for novel superconductors requires robust structure predictions. Genetic algorithm searches and other methods coupled to first-principles relaxations are often limited in their prediction capabilities by the number of atoms in the supercell. As the number of atoms increases, the number of local minima in the energy landscape rises exponentially and the computational cost of relaxations grows polynomially. The room-temperature superconductors of tomorrow might potentially have large unit cells and may contain more than 3 elements. The CSP of such

superconductors can be accelerated by utilizing machine-learned surrogate models of the energy landscape that are trained on small structures. These surrogate models can be built using a variety of choices of structure representation and model architectures, which each offer trade-offs in spatial resolution, computational cost, and fitting complexity. Ideally, surrogate models will be iteratively improved through active learning as additional data becomes available [165].

Many of the techniques used until now in search of high-temperature electron–phonon superconducting materials may be applied to the analysis of unconventional superconductors, where Cooper pairs form due to the exchange of electronic rather than phononic excitations. Examples of unconventional superconducting materials are cuprates, iron-based superconductors, and heavy fermions. Unlike electron–phonon systems, however, a unified theory of superconductivity that could explain the variety of phenomenology shown by the various families of unconventional superconductors is not yet available. Approximate, often successful but uncontrolled methods formulated based, for example, on spin fluctuation-mediated superconductivity [166] have not been convincingly coupled to first-principles electronic structure calculations, and therefore DFT-based descriptors important for unconventional superconductivity are less well understood.

### 18.3. Advances in science and technology to meet challenges

Recently, we extended a symbolic regression approach to study a large sample of  $\alpha^2F$ 's generated from EPW electron–phonon calculations for 50 real materials and 5000 artificial  $\alpha^2F$ 's of multimodal form. The solution of the isotropic Eliashberg equation, given  $\alpha^2F$ , is relatively inexpensive. Using the resulting dataset, which is two orders of magnitude larger than that of the previous work [160], we obtained a new correction for the McMillan formula that supersedes the AD equation, especially for systems with higher  $T_c$  [167]. Figure 26(a) illustrates the performance of the AD formula on low- $T_c$  materials such as elemental metals, hydrides such as LaH<sub>10</sub> and H<sub>3</sub>S, and the bimodal Einstein's used to augment the training dataset. The systematic underprediction of  $T_c$  with the AD formula is absent from predictions made with a new machine-learned equation, shown in figure 26(b). Moreover, we were able to determine that deviations of AD from Eliashberg theory, for large  $\lambda$  systems, arose primarily from the inequivalence of the  $\alpha^2F$  moments  $\omega_2$  and  $\omega_{\log}$ .

Based on the success of augmenting the data using model systems based on multimodal Einstein's, it is clear that generative models are another promising avenue for improved machine-learning of  $T_c$ . Figures 26(c) and 1(d) illustrate one method of generating  $\alpha^2F$  spectra using an autoencoder neural network. Training data, including known examples of  $\alpha^2F$ , are first discretized through binning or basis set expansion. The autoencoder learns an efficient compression of the data into a lower-dimensional 'latent' space, shown here as dimensions  $x_1$  and  $x_2$ , by iteratively minimizing the error between the input and the reconstructed output. The trained decoder, comprised of the layers after and including the autoencoder

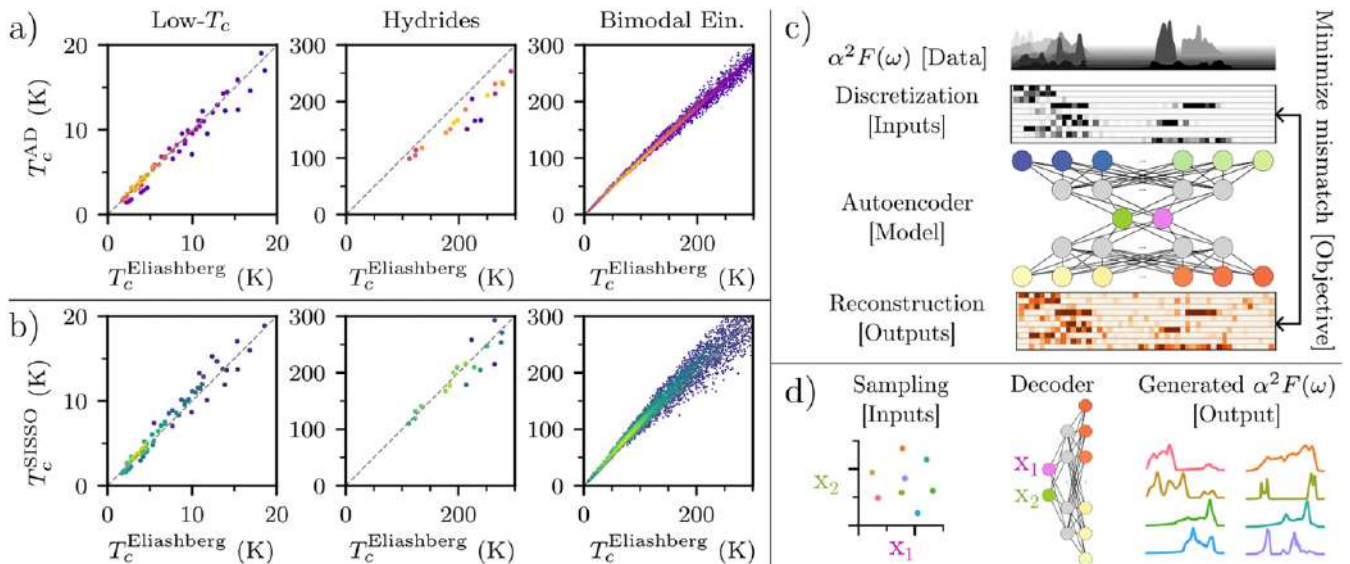

**Figure 26.** Performance comparison between the AD equation [2] and a model fit with symbolic regression alongside a proposed workflow for data augmentation. (a) AD performance on low- $T_c$ , hydrides, and bimodal Einstein data. Plots are shaded by the log-density of points. (b) Performance of symbolic regression ML model. (c) Workflow for training an autoencoder neural network to learn an efficient compression of  $\alpha^2 F$ . The mismatch between the original input and the reconstructed output, after compression and decompression, is minimized iteratively. (d) The latter half of the trained autoencoder, known as the decoder, generates new  $\alpha^2 F(\omega)$  spectra by sampling the learned distribution.

bottleneck, can then transform any sampled point in the latent space into a  $\alpha^2 F$ . Coupled with the Eliashberg equations, this approach augments the dataset with arbitrarily-many training samples that are qualitatively realistic compared to model systems.

Combined with high-quality databases as well as generative models, deep learning approaches to learning superconductivity have become increasingly practical. The artificial neural network offers a high degree of model flexibility and, when combined with physical and chemical insight, can learn and predict across the periodic table [168]. Moreover, recent efforts to move away from black-box approaches have resulted in frameworks like SciNet, which can extract physics from the data by identifying and isolating relevant physical quantities [169]. Similarly, the discovery of empirical equations using symbolic regression [170] can be accelerated by using deep learning to discover hidden symmetries and separate harder problems into multiple, simpler ones [171].

For unconventional superconductors, a more promising approach is to use empirical knowledge about the normal state of systems that support unconventional superconductivity. For example, unconventional superconductivity is often found near phase transitions where magnetism disappears via doping or applied pressure. Such ‘soft’ magnetic states can be identified by high-throughput DFT calculations of magnetic candidate materials (mostly metallic compounds in materials database with transition metal ions), calculating how magnetism responds to applied pressure. Promising materials where magnetization decreases rapidly can then be synthesized and studied further by doping and/or pressure. A more theoretically guided approach is based on a weak-coupling

scenario in which spin-excitations provide the effective attractive interactions between electrons. In this case, our strategy is to look for the optimal conditions to find a large spin susceptibility peaked at a particular momentum that could reflect in a strong pairing at this wave vector. Nesting wave vectors on FSs are often proxies for such peaks and can also be searched for in high-throughput schemes.

#### 18.4. Concluding remarks

We have outlined an approach to superconductor discovery that seeks to identify the electronic properties of a material that are essential for high  $T_c$  via ML techniques. One thrust is to develop improved equations for  $T_c$  of the AD type capable of accounting for large- $\lambda$  materials like high-pressure superconducting hydrides. We discussed the challenges of creating sufficiently large databases of Eliashberg  $\alpha^2 F$ 's using expensive electron-phonon calculations for real materials and addressed them by the creation of artificial  $\alpha^2 F$ 's with modeling of simple physically motivated form, and the use of autoencoders, both equally good for learning Eliashberg theory. We also discussed future directions, including structure prediction utilizing surrogate ML models of energy landscapes to inform studies of metastable materials synthesized under high pressure, and extension of current methods to unconventional superconductors.

#### Acknowledgments

The work was supported by the US Department of Energy Basic Energy Sciences under Contract No. DE-SC-0020385.



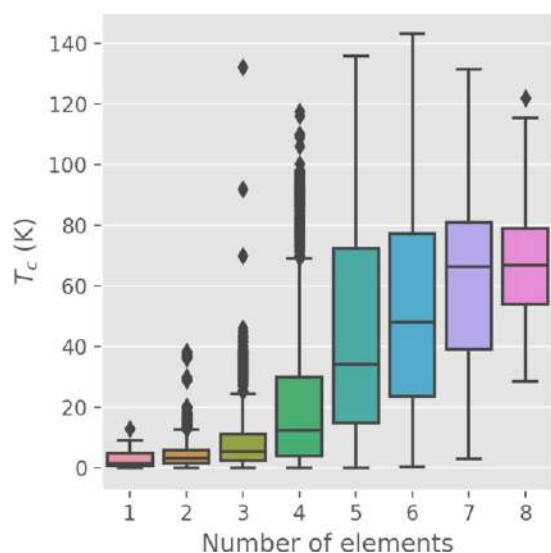

**Figure 27.** Boxplot of superconducting transition temperatures  $T_c$  of materials grouped by the number of elements. Growth of  $T_c$  is associated with increase in materials complexity.

## 19. Artificial intelligence in the search for new superconductors

Valentin Stanev

University of Maryland, United States of America

### 19.1. Status

Superconductors are both an arena of profound physical effects, and a class of solids with many important applications in a variety of technological areas. Ever since their discovery more than a 100 years ago, these materials have been the focus of an intense research effort. However, the search for new superconductors remains an immense scientific challenge. So far, scientists have relied almost exclusively on heuristics and individual researchers' intuition for this task, and nearly all major discoveries in the field were serendipitous. While some empirical design rules do exist, these are mostly deduced from simple elemental or binary compounds, and are of very limited applicability. Despite the constant evolution of *ab initio* methods and the exponential growth in computational power, calculating properties such as the critical temperature ( $T_c$ ) for even well-understood conventional superconductors remains challenging and arduous task. In addition, entire families of superconductors (e.g. cuprate and iron-based materials) are not amenable to standard *ab initio* tools, for example due to strong correlations and proximity to magnetism. Furthermore, higher  $T_c$  is generally associated with more complex multicomponent materials (see figure 27). However, even with the help of advanced high-throughput experimental methods, it is impossible to exhaustively explore a synthesis space exponentially growing with each compositional and processing parameter. Thus, novel search strategies are needed in order to meet the growing demand for new superconductors.

AI, especially its subfield of ML, is becoming a common research tool, with important applications in virtually all sciences. ML is already making its mark on physics by providing a robust framework for analysis of high-dimensional experimental and computational data. While AI only just debuted as a research tool in condensed matter physics, it is already attracting the attention of scientists searching for new superconductors.

### 19.2. Current and future challenges

AI methods can play a significant role in every stage of the search for new superconductors. Probably the most common application of these methods so far is to analyze experimental and/or computational datasets in order to discover strong predictors of superconducting behavior. These predictors can then be used to screen existing or potentially stable materials for candidate superconductors. Several works have already used this approach to create lists of potential superconductors. For recent examples of this approach, see references [162, 172, 173].

While easy to implement, the method of virtual screening of materials is fundamentally limited by the fact it requires a starting list of candidates with a complete set of predictors. An alternative, more sophisticated framework utilizes the so-called inverse design approach: engineering a material possessing some predefined set of properties. Although inverse design methods have a long history in materials physics (see, for example, reference [174]), their recent integration with generative models based on deep learning ideas makes them much more powerful and flexible [175]. While these methods have not been used so far in the search for new superconductors, this undoubtedly is only a matter of time.

Even if the theoretical search and design stage leads to a list of likely candidates, synthesizing materials with the correct composition and structure can be challenging. In addition, chemical substitution plays an important role in tuning the properties of many classes of superconductors. Thus, experimental research will remain a crucial stage and a potential bottleneck in the search for new superconductors. AI can help significantly accelerate and streamline this process. Condensed matter experimentalists can use AI algorithms to select the next best experiment to perform in order to find the shortest path toward a superconducting material that optimizes some desired properties. This idea was explored in reference [176], which presented a framework designed to discover the material with the highest  $T_c$ . The framework, evaluated on about 600 known superconductors, did significantly better than a method based on random guessing. The authors of this work emphasized the need to incorporate uncertainty estimates, especially when evaluating candidates in new regions of the design space.

### 19.3. Advances in science and technology to meet challenges

One crucial issue that can hamper the use of AI methods is the availability of data. The study of superconductivity is a remarkably distributed field, and every experimental and

theoretical group has its own distinct toolbox of instruments and methods. Although sometimes even a single study can generate enough data to require the use of sophisticated ML methods (see, for example, reference [177]), typical AI studies in the field require combining many distinct datasets. This can lead to issues with data consistency and incomplete metadata. The community has not yet fully adopted the open data paradigm, and a significant fraction of the collected information—especially ‘negative’ results—are not shared. Although there is a database—SuperCon (<https://supercon.nims.go.jp/en/>), curated by the Japanese National Institute of Materials Science—containing a list of superconducting materials and their corresponding  $T_c$  extracted from published literature, most of the accumulated knowledge is still dispersed between tens of thousands of articles. One possible solution is to use Natural Language Processing (NLP) tools and other ML techniques to algorithmically extract information from unstructured scientific data (articles’ text, tables, figures, etc). In a very recent example, the authors of reference [178] used NLP methods to reconstruct the phase diagrams of well-known superconducting compounds using data from published articles. They also demonstrated that it is possible to predict the phase-transition temperatures of compounds not present in the database.

As AI becomes a common tool in physical research, a novel form of scientific AI is gradually emerging. It represents a framework for combining new computational and experimental data with a significant body of already existing knowledge in the form of physical laws, theoretical hypotheses, and empirical rules. In the first work of this kind in the field of superconductivity, researchers used ML to select low-dimensional descriptors and a simple analytical expression to improve the AD formula for predicting the  $T_c$  of electron–phonon paired superconductors [160]. Further extending the scientific AI framework to help in the search for novel superconductors will require the concerted efforts of physicists and AI experts working together.

#### 19.4. Concluding remarks

As physicists begin to explore more and more complex materials, their research methods have to evolve. The ongoing revolution in AI is a great opportunity for the condensed matter physics community, particularly in fields still dominated by serendipity and accidental discoveries such as the study of superconductors. The AI methods can play a significant role in every stage of the search for new superconductors, from discovering strong predictors of superconductivity which can be used to generate lists of candidate materials, to orchestrating efficient experimental campaigns to synthesize and characterize these candidates.

#### Acknowledgments

The author acknowledges Ichiro Takeuchi for many insightful discussions.

## VI. Other (non-hydride) superconductors

### 20. Is protonation (hydrogenation) the future of conventional superconductivity at room pressure?

Renato S Gonnelli<sup>1</sup>, Erik Piatti<sup>1</sup>, Davide Romanin<sup>2</sup> and Dario Daghero<sup>1</sup>

<sup>1</sup>Politecnico di Torino, Italy

<sup>2</sup>Sorbonne Université, France

#### 20.1. Status

In the early Seventies, a few outstanding results appeared in the literature demonstrating the induction of superconductivity in Pd, with critical temperatures up to  $T_c = 9.4$  and 11 K, via low-temperature hydrogen (H) and deuterium (D) implantation, respectively [179]. Two years before, the  $T_c = 1.37$  K of elemental Th had been boosted to 8.2 K via high-temperature exposure to hydrogen gas, which resulted in the compound  $\text{Th}_4\text{H}_{15}$  [180]. Even higher critical temperatures,  $T_c = 16.6, 15.6, 13.6$  K, were obtained in  $\text{Pd}_{1-x}\text{M}_x$  alloys (with  $M = \text{Cu, Ag, Au}$ , respectively) by low-temperature H implantation, as done in Pd [181]. Then, H was implanted in other alloys of Nb, Pd, Pd–Mo and Rh, often obtaining a remarkable increase in  $T_c$ . These interesting results (some of which are summarized in figure 28) fell into oblivion after 1986, when the interest of the superconductivity community became completely absorbed by high- $T_c$  cuprates. Few studies on the effect of H absorption in  $\text{YBa}_2\text{Cu}_3\text{O}_7$  showed a modest ( $<2.6$  K) increase of  $T_c$ . However, interest in the protonation of metals and alloys has been revived by the recent discovery of very high- $T_c$  superconductivity, between 204 K and 288 K, in  $\text{H}_3\text{S}$ ,  $\text{LaH}_{10}$  and in the carbonaceous sulfur hydride (CHS) system, at pressures of a few megabar (see references to section 1 and figure 28). Further details on hydrogen-modified superconductors can be found in a recent review [182]. In the last few years, a large increase of  $T_c$  or the induction of a superconducting phase was demonstrated by using a novel protonation technique (described below) in iron-based superconductors of the 11 family ( $T_c$  boost from 8.5 to 41 K in FeSe), in  $\text{ZrNCl}$  ( $T_c = 15$  K) and in the transition metal dichalcogenide (TMD)  $1\text{T-TaS}_2$  ( $T_c = 7.2$  K) [183]. Also these new results are reported in figure 28. Clearly, there exists a huge number of materials that may potentially develop superconductivity once protonated, including simple metals and alloys, layered iron-based compounds, 2D TMDs, and graphite intercalated compounds (GICs). The field is poorly explored up to now, but could lead to the discovery of new materials and new potential applications.

#### 20.2. Current and future challenges

A modern application of the protonation technique faces many challenges. The first and foremost issue concerns the methods of protonation. In the early experiments, and up to 2010, three approaches, or a combination thereof, were used: (i) absorption from H gas at high temperature and pressure;

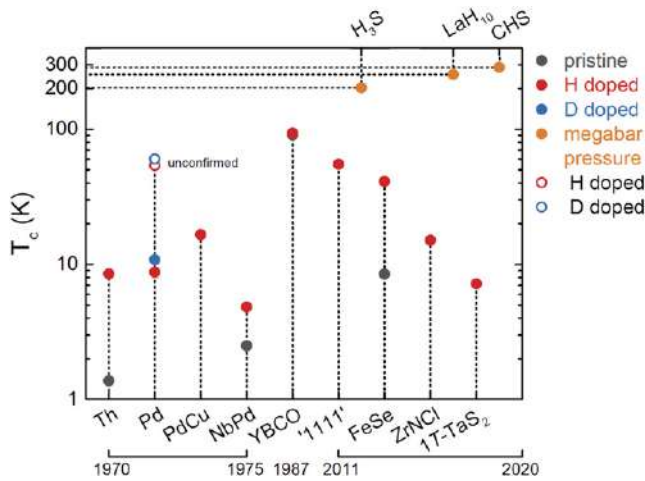
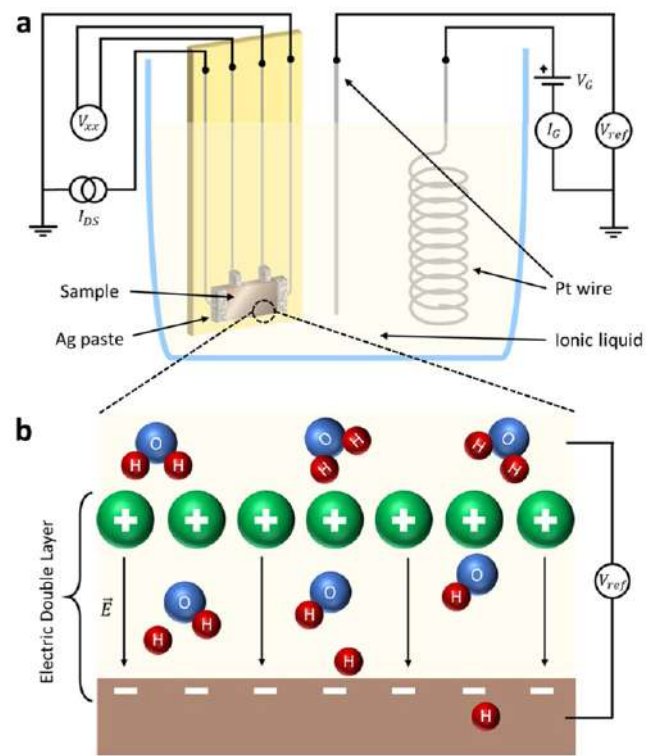

**Figure 28.** Maximum superconducting transition temperatures achieved in different hydrogen-based or hydrogen-doped compounds. These include hydrogen- and deuterium-doped compounds stable at ambient pressure (filled red and blue circles, respectively), and hydrogen-rich compounds synthesized and stable at megabar pressures (filled orange circles). Hollow symbols represent the unconfirmed metastable phases of PdH<sub>x</sub> and PdD<sub>x</sub> stabilized by rapid quenching to low *T*.

(ii) electrochemical loading at room *T* (or low *T*) by electrolysis of H<sub>2</sub>SO<sub>4</sub> or HCl solutions; (iii) direct implantation of H<sup>+</sup> (protons) and D<sup>+</sup> ions at liquid-helium temperature [182]. All these methods are complex and suffer drawbacks mainly related to the *in-situ* vs *ex-situ* measurements of the H content and of the superconducting properties. To allow a high-throughput investigation of new materials, and to open potential routes to applications, it is thus necessary to reduce the complexity and the cost of the process, and to find less demanding physical conditions for protonation.

Another challenge is the stabilization of the protonated phase that may be unstable or metastable. For example, the tendency of Pd to lose the loaded H (even at room *T*) due to its diffusion in the structure is well known, and some papers claim a *T<sub>c</sub>* ~ 54 K in PdH<sub>x</sub> obtained by using special techniques to stabilize the high-*T<sub>c</sub>* phase [184], i.e. rapidly quenching the protonated sample to low *T*. A third important issue concerns the selection of the classes of starting materials. Different criteria can be envisaged and based on: (i) serendipity; (ii) existence of superconducting phases obtained by other methods in the same or similar materials; (iii) *ab-initio* theory-driven selection. However, the analogy does not necessarily work (e.g., in MoS<sub>2</sub> ionic gating induces superconductivity, but our preliminary investigations suggest that protonation does not); on the other hand, the ‘*a priori*’ theoretical approach is often so complex and time-consuming to be virtually impossible.

Finally, a great challenge is given by the theoretical explanation of the experimental results. In principle, protonation may affect different properties of the starting material: crystal structure, electronic bands, phonon spectrum and electron–phonon coupling. Disentangling the most important effect (or combination of effects) toward the appearance of superconductivity is usually a complex theoretical and experimental task.



**Figure 29.** (a) Sketch of the experimental setup for ionic-gating-induced protonation, including Pt electrical wires for the application of the gate voltage *V<sub>G</sub>* and the measurement of both the reference voltage *V<sub>ref</sub>* and the four-wire resistivity of the sample. (b) Sketch of the EDL generated by a positive *V<sub>G</sub>*, made up of the Helmholtz layer of cations and the counter-charge in the gated sample. The absorbed water molecules are split by the intense electric field and the H<sup>+</sup> ions are then driven into the material.

### 20.3. Advances in science and technology to meet challenges

The first two challenges can be addressed by a new protonation technique [185, 186], already successfully used in some layered materials [183], based on an ionic-gating-like setup. It exploits the strong electric field in the electric double layer (EDL) at a polarized solid-electrolyte interface to dissociate the water molecules in the electrolyte and drive the H<sup>+</sup> ions into the material (figure 29(b)).

In its basic version, this simple technique only requires a low dc gate potential (*V<sub>G</sub>* ~ 3 V), the water naturally absorbed by hygroscopic ionic liquids, and a temperature close to 300 K or slightly higher [183]. Simple improvements can be envisaged to monitor the time evolution of the process and the real-time change in transport properties, as well as to estimate the amount of H<sup>+</sup> ions loaded in the sample. For example (figure 29(a)) if a reference electrode is immersed in the electrolyte, *V<sub>G</sub>*, *V<sub>ref</sub>*, the gate current *I<sub>G</sub>* and temperature can be measured during the gating process. Placing proper contacts on the sample surface will also allow *in-situ* measurement of its four-wire resistivity. A similar setup can even be mounted in a cryostat, thus permitting a rapid quenching of the loaded H ions and the subsequent low-*T* measurements.

The theoretical modeling of protonated materials is a delicate task. The most energetically favourable position of protons in the crystal must first be determined. Since their presence may modify both the lattice parameters and the atomic positions of the pristine sample—thus affecting its vibrational properties—one has to understand: (i) whether they simply induce a shift of the chemical potential or modify the electronic bandstructure through hybridization of H atomic orbitals; (ii) if and how the vibrational modes of the protons couple to those of the pristine system (i.e., if they just add Einstein modes or affect the phonon spectrum in a non-trivial way). Due to the hydrogen light mass, the correct phonon dispersions may also require anharmonic corrections [187, 188]. Therefore, it is crucial to correctly model all these aspects as they have a direct impact on the electron–phonon interactions and their related effects, in particular the superconducting coupling.

#### 20.4. Concluding remarks

In the present short contribution, we have shown that the time is ripe for an intense and systematic resumption of protonation (and hydrogenation) experiments to search for new H-based superconducting materials. The recent introduction of the simple and effective ionic-gating-induced protonation technique and its improvements outlined in the previous paragraph will allow high-throughput experiments able to rapidly span over the different families of potential candidates mentioned above. At the same time, recent advances in *ab-initio* computational methods for solid state physics (including high-throughput and genetic algorithms) will make it possible to guide the selection of materials to be protonated and to interpret the results of the experimental activity. The new superconductors that will be discovered by this approach will probably feature a  $T_c$  lower than room temperature, but will be simple, possibly BCS-like, and most importantly stable at ambient pressure, thus opening the way for potential future applications.

#### Acknowledgments

We thank G Profeta and G Lamura for fruitful scientific discussions. We acknowledge funding from the MIUR PRIN-2017 program (Grant No. 2017Z8TS5B—‘Tuning and understanding Quantum phases in 2D materials—Quantum2D’).

## 21. Predicting unconventional superconductors from first principles

Roser Valenti

Goethe-Universität Frankfurt, Germany

### 21.1. Status

Since the discovery of high-temperature superconductivity in copper-oxide materials in 1986 [189] there has been an intensive search for unconventional superconductors with exotic superconducting pairing mechanisms beyond phonon-mediated BCS (Bardeen–Cooper–Schrieffer) [190] and, with

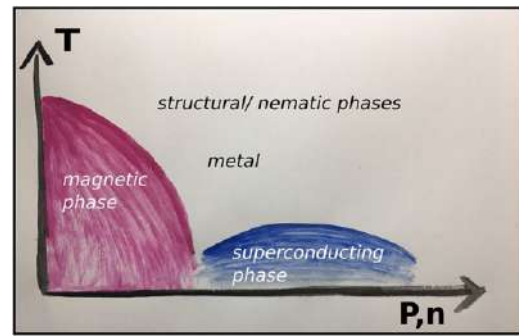

**Figure 30.** Generic temperature ( $T$ ) versus pressure ( $P$ ) or doping ( $n$ ) phase diagram for unconventional superconductors containing a magnetic phase nearby or coexisting with superconductivity, as well as, depending on the system, a variety of other phases such as (bad) metal, nematic and structural phase transitions.

desirable high transition temperatures. A common feature of many of these unconventional superconductors is that they are strongly correlated electron systems and, magnetism and superconductivity either coexist or are nearby in their phase diagram (see figure 30). This observation heavily suggests that spin fluctuations are a key ingredient for superconductivity.

Notorious families of existing unconventional superconductors are—apart from high- $T_c$  cuprates [189]—heavy fermions [191], organic conductors [192, 193],  $\text{Sr}_2\text{RuO}_4$  [194] and Fe-based superconductors [195]. Most recently, magic-angle twisted bilayer graphene [196] has been added to this fascinating ensemble of systems. Predicting materials with similar properties is however a difficult task since the origin of unconventional superconductivity remains a puzzling open question. In most of these systems superconductivity emerges from magnetism either upon doping them or/and by application of pressure. This feature sets a possible procedure to try to design materials with similar behavior from first principles [197]. In the following we describe the challenges and opportunities of such an undertaking.

### 21.2. Current and future challenges

In the prediction of unconventional superconductors from first principles, several challenges appear. Here, we highlight a few of them:

- By their nature, unconventional superconductors are strongly correlated electron systems. A prediction of such systems and analysis of their superconducting state from first principles requires a description beyond conventional DFT in order to properly include correlation effects. In recent years there have been some efforts to develop adapted XC functionals in DFT [143]. Alternatively, the combination of DFT with many-body techniques such as dynamical mean field theory [198] and its extensions [199], RPA [200], two-particle-self-consistent approach [201], or functional renormalization group [196]—to mention a few—has been rather successful. This combination of methods has helped to advance our understanding of unconventional superconductors.

- Albeit the limitations of conventional DFT to describe correlated materials, this technique is extremely useful to investigate the intrinsic magnetism in many of these unconventional superconductors. More challenging is, however, to relate such magnetic simulations to superconductivity [202].
- In contrast to most superconductors, where superconductivity sets in upon cooling the material in its stoichiometric form or, in the very exceptional case of the hydrides, through application of extraordinary pressures, unconventional superconductivity in correlated electron systems arises mostly after manipulating the materials either via chemical or electrical doping or via pressure or strain. This makes the search for new unconventional superconductors from first principles difficult already at the level of DFT, since it requires simulations of complex supercells to account for doping effects, as well as multiple simulations under various pressure/strain conditions to identify possible superconducting phases [203]. In the continued search for new superconductors, a better understanding of how to tune materials toward desired parameter regimes is therefore of continued interest. Various approaches are being explored including not only combinations of chemical crystal engineering and physical pressure or strain, but exfoliation of 2D materials and formation of hybrid structures as well.
- The complexity of first principles simulations enforces sometimes the use of minimal effective models, such as generalized Hubbard models, to describe these systems where the information of the specific material is encoded in the hopping and interaction parameters of the model. To understand even the minimal models—applicable to arbitrary unconventional superconductors—continued development of numerical methods is needed to predict properties, in order to compare with experiments and characterize the models.
- Finally, the implementation of ML algorithms and statistical methods [204, 205] may be useful in the search, design and prediction of unconventional superconductors.

### 21.3. Advances in science and technology to meet challenges

From the perspective of new material searches, finer chemical control of disorder, often present in unconventional superconductors, is an ever-present target. For understanding the effects of disorder, doping, strain and pressure, further development of first principles structure predictions is likely to continue playing a prominent role.

From the modeling perspective, adapting various numerical many-body methods to treat correlation effects as well as electron-lattice interactions on the same footing is highly desirable.

Finally, topological superconductors are emerging as a platform for exotic states. Naturally occurring topological superconductors are rare, with some exceptions like the recently most discussed  $\text{UTe}_2$  [206]. Other options are topological insulators with induced unconventional superconductivity [207]

that have the potential to host Majorana fermions and to exhibit supersymmetry, and they also hold promise for technological applications, including topological quantum computation and spintronics.

### 21.4. Concluding remarks

Unconventional superconductivity in strongly correlated electron systems is a very exciting and, at the same time, very puzzling state of matter. Searching for high- $T_c$  unconventional superconductors in this class of materials remains a challenging task. However, the recent developments both on the modeling side with advanced numerical techniques and the application of ML algorithms, as well as developments on the experimental side, including efforts of merging superconductivity with topology opens a myriad of opportunities to be explored yet.

### Acknowledgments

We acknowledge financial support by the Deutsche Forschungs-Gemeinschaft through Grant (DFG) for funding through TRR 288–422213477 (B05). This research was supported in part by the National Science Foundation under Grant No. NSF PHY-1748958.

### Data availability statement

The data that support the findings of this study are available upon reasonable request from the authors.

### Appendix A. Q & A on current and future challenges in room-temperature superconductivity: a virtual round table

While collecting contributions for this roadmap, we asked all contributors to share their views on the current and future challenges in the field, by answering four questions. The answers, collected below, offer a nice picture of the current status of superconductivity research.

Q1: What do you find exciting in this field?

Arita: *Ab initio* prediction (or materials design) of new superconductors is a very fascinating topic for me.

Pickard: Of course—the possibility of realising the dream of ‘room conditions’ superconductivity is incredibly exciting, especially if the result leads to technological materials. But just as exciting is that the progress made so far shows that the triangle theory/computation/experiment show the way forwards for the design of future materials.

Kolmogorov: The acceleration of structure searches with MLIPs. What I find the most exciting about these advances is that the models can now be generated virtually without any supervision and they are fast enough to accelerate *ab initio* search by orders of magnitude. The methodology has the potential to dramatically expand the search for new materials in general and new superconductors in particular. With all the successful ML designs introduced in recent years, there have been surprisingly few predictions of thermodynamically

stable materials made with the help of MLIPs. Further automation and dissemination of the ML tools will help evaluate the benefits of using the methodology for different materials classes.

Heil: One thing that excites me here is that the pace of research progress is so high at the moment. It seems that almost every day there are new studies and reports adding to our current understanding. Of course, the fact that we are currently working at such extreme conditions that have been unattainable experimentally not so long ago adds to the excitement, as we are breaking completely new grounds here. Lastly, the fact that el–ph superconductivity has been calculated and measured to reach critical temperatures close to room temperature is amazing, when considering that for almost 100 years people thought 25 K was the upper limit for conventional superconductivity.

Stanev: I am really excited about the advent of AI and ML methods in the study of superconductivity. The methods offer tools that can help address some of the biggest challenges in the field. Extracting and organizing information dispersed over thousands of papers, visualizing and analyzing high-dimensional data, even orchestrating an efficient experimental campaign—it has already been demonstrated that AI can be used for all of these. Since superconductivity has been studied for more than a century, there is plenty of experimental and computational data available. AI is uniquely suited for the task of analyzing the data created by generations of researchers and turning it into actionable knowledge.

Errea: This field is so exciting because, for the first time, we know that hydrogen-based compounds can be room temperature superconductors, one of the ultimate goals of science. The challenge now is to understand if these compounds can also have record critical temperatures at lower pressures, even ambient pressure.

Zurek: First of all, I am excited about all of the novel chemistry that emerges under pressure. Uncovering new bonding rules that can be used to explain the unique stoichiometries and structures that become stable is great fun. Secondly, I find it remarkable that theoretical predictions are really driving this field forward. The synergy between theory and experiment, and how it has led to such quick advances is a success story.

Yanming Ma: Room-temperature superconductivity has been a century long-held dream since the discovery of the first superconductor mercury in 1911. Now the dream is becoming true in the system of hydrogen-rich superconductors stabilized under high pressure, where the highest  $T_c$  for clathrate structured LaH<sub>10</sub> reaches 260 K. Future study toward ternary hydrogen-rich superconductors is exciting in view of the recent report on a C–S–H system with  $T_c$  at 280 K though more experiments are needed to confirm the results. An era of ‘hot’ superconductors in the hydrogen-rich systems under high pressure might come soon.

Margine: We are now witnessing a remarkable progress in the development of advanced computational methods, in particular for treating electron–phonon and electron–electron interactions on an equal, *ab-initio*, footing. This could help shed light on important unsolved questions regarding the role

of Coulomb correlations in different classes of superconductors. Furthermore, developments aimed at including effects arising from plasmons and spin fluctuations open the door for exploring their impact on the superconducting pairing.

Eremets: Realisation that high pressure is a really powerful tool which brings new prospects to the field of superconductivity, room temperature superconductivity, and likely will influence the search of HTSC at ambient pressures. Second, a remarkable synergy of theory, calculations and experiment, close interaction with the theoreticians, tremendous progress, especially in the last few years.

Q2: How do you think we can get to room temperature room pressure SC?

Arita: For room temperature SC, I expect that it will soon be realized in hydrogen compounds. The question is whether we can retain those high  $T_c$ 's at ambient pressure. For this problem, I am not so optimistic, although we may have a chance to find some metastable structure. To realize room temperature superconductivity at ambient pressure, I think that we should search for another unconventional superconductor.

Pickard: I would be surprised if we can get to room temperature and zero pressure using hydrogen. I expect other light elements will be needed.

Heil: Obviously we still need to collect a lot of information in order to be able to point to a clear path to achieve room temperature superconductivity at ambient pressures, as despite the tremendous research efforts and gained knowledge so far, a large area is still unexplored. In my opinion, with research focus now turning to ternary hydride compounds, there will be quite a number of reports of highest- $T_c$  superconductivity at much lower pressures compared to the binary hydrides. This will help to pinpoint and carve out the essential properties and particularities to reach room temperature/pressure superconductivity.

Errea: Since the superconducting mechanism here is the well-known electron–phonon interaction, a combination of theory and experiment allows fast progress. This will be crucial as well for the next discoveries. However, theoretical and experimental techniques need to advance.

Zurek: We need to find a way to kinetically stabilize the superconducting materials. This can only be done by introducing some sort of framework of elements that can form strong bonds, such as elements from group 14–16.

Yanming: I do not see an immediate step to reach room temperature superconductivity at room pressure. But it becomes a certainty for finding room temperature superconductivity in hydrogen-rich compounds under high pressure. Ternary or quaternary hydrides under high pressures are the good candidates for room temperature superconductors.

Eremets: A case of H<sub>3</sub>S as a covalent metal likely shows a workable way. Carbon-based and other materials with light atoms have characteristic frequencies comparable with H<sub>3</sub>S. Doping or alloying can turn them to covalent metals (as pressure does for hydrides) and superconductors.  $T_c > 78$  K is likely to be achieved according to the calculations and thanks to progress in the experiment. RTSC probably will be found in this way, this does not contradict the basics.

Q3: What are the main technical challenges?

Arita: I think that the most important challenge is the development of a non-empirical and non-perturbative method which enables us to study unconventional superconductivity from first principles.

Pickard: From the computational side, the main challenge is to perform high quality (converged)  $T_c$  computations at sufficient scale. Experimentally and computationally we need to understand why the number of synthesised superconducting compounds is relatively low, as compared to the number of predictions.

Heil: For me as a theorist, I see the main challenges in the sheer number of possible configurations of the structural search space, which means clever, efficient and unbiased structure search methods are of essential importance. Furthermore, we have already seen for a couple of hydride compounds that anharmonic effects and also temperature effects can have significant impact on the materials' properties. Although methods do exist to include these effects, they are currently very expensive computationally.

Errea: From the theoretical side a proper treatment of ionic quantum fluctuations is required. It has been shown that these effects can stabilize crystal structures with huge electron–phonon interaction at much lower pressures than expected otherwise. The challenge is to incorporate these ionic quantum effects into CSP methods. From the experimental side new developments are expected to better control the chemical reactions that yield high-temperature superconducting hydrides at high pressures.

Zurek: In the field of CSP currently we can quite reliably predict many stable and metastable crystal structures. But we do not know quite yet how to choose which stoichiometries and unit cell sizes to consider, how to set limits on which structures should be more thoroughly interrogated, and set criteria for what could be synthesizable. Currently, much of this boils down to choices that human beings make based on intuition and imperfect information.

Yanming Ma: There are several technical challenges. (i) Synthesis of thermodynamically stable ternary or quaternary hydrides in experiments; (ii) experimentally, the determination of compositions and crystal structures of the hydrides superconductors is challenging since hydrogen is not seen in XRD data; (iii) measurement of magnetic susceptibility under high pressure that is a must for verifying the superconductivity is challenging.

Margine: Modeling large, realistic systems from first principles will remain a formidable challenge for future research.

Eremets: From an experimental point of view, we are prepared technically better for the search of new superconductors at high pressures rather than at ambient pressure. We already reached 410 GPa at 2250 K. Still, the efficiency of high pressure experiments is not satisfactory—currently we produce much fewer works than theoreticians do. Ambient pressure is a challenge for high-pressure laboratories. We can synthesize some samples based on the high pressure experience—a pilot search. We can also do some characterization. But the synthesis of materials on a large scale, and their characterization requires a well-equipped material science laboratory.

Q4: Which directions do you see as most promising in superconductivity?

Arita: While *ab-initio* prediction of unconventional superconductivity is very fascinating, materials design of conventional superconductors is also exciting. Even if the transition temperature cannot be higher than 40–50 K at ambient pressure, if it is malleable and ductile, it will be very useful in many applications.

Pickard: Exploiting entropy to design new superconductors—either dynamically stabilised systems, or doping and alloys, and probing the full energy landscape.









Heil: For me, this would be a combination of topics mentioned in points 2 and 3. Firstly, I do think that we can still learn a lot about electron–phonon interaction and the hydrides' properties in general by investigating a lot of different ternary compounds. For the binary ones, we have already seen that one can categorize them, very broadly speaking, into two different classes (covalent hydrides and hydrogen-rich SLC structures), and I am very excited to see how the ternary structures fit into this picture and if there are new classes even to be found. Secondly, I think that the inclusion of anharmonic and temperature effects will be crucial to really understand these materials on a quantitative level, and further research efforts will need to be spent to enable a more streamlined and efficient way to incorporate these effects in our current workflows.

Errea: A systematic theoretical search based on CSP methods will continue with ternary compounds. In parallel, crystal structure searches with ionic quantum effects will be incorporated. Provided a clear chemical understanding of why these compounds are high- $T_c$  compounds is built in the community, these searches will provide new interesting compounds in the near future. Hopefully, new high- $T_c$  compounds at lower pressures.

Zurek: The advances made in superconducting hydrides is phenomenal and the field is moving at lightning speed. I think this will continue to be the main driver for discovering new superconducting compounds for a while.

Eremets: At present, conventional superconductivity has a great potential for finding 'hot' superconductivity at high pressure and new superconductors at least with  $T_c > 78$  K at ambient pressure. Superconductors with other than phonons 'glue' for electrons can probably provide higher critical temperatures. As soon as quantitative theories emerge, we can expect the same fruitful symbiosis between theory, computation, and experiment that proved so successful for the superconducting hydrides.

## ORCID iDs

Boeri Lilia  <https://orcid.org/0000-0003-1186-2207>  
 Richard Hennig  <https://orcid.org/0000-0003-4933-7686>  
 Peter Hirschfeld  <https://orcid.org/0000-0003-0375-7386>  
 Gianni Profeta  <https://orcid.org/0000-0002-0535-7573>  
 Antonio Sanna  <https://orcid.org/0000-0001-6114-9552>  
 Eva Zurek  <https://orcid.org/0000-0003-0738-867X>  
 Warren E Pickett  <https://orcid.org/0000-0003-4591-7691>  
 Maximilian Amsler  <https://orcid.org/0000-0001-8350-2476>

Ranga Dias  <https://orcid.org/0000-0002-0830-4928>  
 Mikhail I Eremets  <https://orcid.org/0000-0001-9861-3152>  
 Christoph Heil  <https://orcid.org/0000-0001-9693-9183>  
 Russell J Hemley  <https://orcid.org/0000-0001-7398-8521>  
 Hanyu Liu  <https://orcid.org/0000-0003-2394-5421>  
 Yanming Ma  <https://orcid.org/0000-0003-3711-0011>  
 Carlo Pierleoni  <https://orcid.org/0000-0001-9188-3846>  
 Aleksey N Kolmogorov  <https://orcid.org/0000-0002-0669-7756>  
 Nikita Rybin  <https://orcid.org/0000-0001-7053-5295>  
 Dmitry Novoselov  <https://orcid.org/0000-0003-1668-3734>  
 Vladimir Anisimov  <https://orcid.org/0000-0002-3683-861X>  
 Artem R Oganov  <https://orcid.org/0000-0001-7082-9728>  
 Chris J Pickard  <https://orcid.org/0000-0002-9684-5432>  
 Tiange Bi  <https://orcid.org/0000-0001-5866-190X>  
 Ryotaro Arita  <https://orcid.org/0000-0001-5725-072X>  
 Ion Errea  <https://orcid.org/0000-0002-5719-6580>  
 Camilla Pellegrini  <https://orcid.org/0000-0003-2614-1111>  
 Ryan Requist  <https://orcid.org/0000-0001-6887-3463>  
 E K U Gross  <https://orcid.org/0000-0002-0113-759X>  
 Elena Roxana Margine  <https://orcid.org/0000-0002-5573-9940>  
 Stephen R Xie  <https://orcid.org/0000-0001-8415-4514>  
 Yundi Quan  <https://orcid.org/0000-0002-6359-9749>  
 Ajinkya Hire  <https://orcid.org/0000-0003-3147-2521>  
 Laura Fanfarillo  <https://orcid.org/0000-0002-6452-8520>  
 G R Stewart  <https://orcid.org/0000-0001-7251-1684>  
 J J Hamlin  <https://orcid.org/0000-0002-8685-153X>  
 Valentin Stanev  <https://orcid.org/0000-0001-6129-133X>  
 Renato S Gonnelli  <https://orcid.org/0000-0001-7108-8458>  
 Erik Piatti  <https://orcid.org/0000-0001-8733-5230>  
 Davide Romanin  <https://orcid.org/0000-0003-1094-5369>  
 Dario Daghero  <https://orcid.org/0000-0003-2180-7682>  
 Roser Valenti  <https://orcid.org/0000-0003-0497-1165>

## References

- [1] Bergmann G and Rainer D 1973 The sensitivity of the transition temperature to changes in  $\alpha^2F(\omega)$  *Z. Phys.* **263** 59
- [2] Allen P B and Dynes R C 1975 Transition temperature of strong-coupled superconductors reanalyzed *Phys. Rev. B* **12** 905
- [3] An J M and Pickett W E 2001 Superconductivity of MgB<sub>2</sub>: covalent bonds driven metallic *Phys. Rev. Lett.* **86** 4366
- [4] Pickett W E 2008 The next breakthrough in phonon-mediated superconductivity *Physica C* **468** 126–35
- [5] Duan D *et al* 2014 Pressure-induced metallization of dense (H<sub>2</sub>S)<sub>2</sub>H<sub>2</sub> with high-*T<sub>c</sub>* superconductivity *Sci. Rep.* **4** 6968
- [6] Drozdov A P, Eremets M I, Troyan I A, Ksenofontov V and Shylin S I 2015 Conventional superconductivity at 203 kelvin at high pressures in the sulfur hydride system *Nature* **525** 73
- [7] Quan Y, Ghosh S S and Pickett W E 2019 Compressed hydrides as metallic hydrogen superconductors *Phys. Rev. B* **100** 184505
- [8] Leavens C R and Carbotte J P 1974 An important parameter in high-temperature superconductivity *J. Low Temp. Phys.* **14** 195
- [9] McMahon J M and Ceperley D M 2011 High-temperature superconductivity in atomic metallic hydrogen *Phys. Rev. B* **84** 144515
- [10] Somayazulu M, Ahart M, Mishra A K, Geballe Z M, Baldini M, Meng Y, Struzhkin V V and Hemley R J 2019 Evidence for superconductivity above 260 K in lanthanum superhydride at megabar pressures *Phys. Rev. Lett.* **122** 027001
- [11] Gaspari G D and Gyorffy B L 1972 Electron–phonon interactions, d resonances, and superconductivity in transition metals *Phys. Rev. Lett.* **28** 801
- [12] Giustino F 2017 Electron–phonon interactions from first principles *Rev. Mod. Phys.* **89** 015003
- [13] Oganov A R, Pickard C J, Zhu Q and Needs R J 2019 Structure prediction drives materials discovery *Nat. Rev. Mater.* **4** 331
- [14] Pickett W E 1979 The generalised pseudoatom potential in solids: relation to screening and lattice dynamics *J. Phys. C: Solid State Phys.* **12** 1491
- [15] Nagamatsu J, Nakagawa N, Muranaka T, Zenitani Y and Akimitsu J 2001 Superconductivity at 39 K in magnesium diboride *Nature* **410** 63–4
- [16] Ashcroft N W 2004 Hydrogen dominant metallic alloys: high temperature superconductors? *Phys. Rev. Lett.* **92** 187002
- [17] Zurek E and Bi T 2019 High-temperature superconductivity in alkaline and rare earth polyhydrides at high pressure: a theoretical perspective *J. Chem. Phys.* **150** 050901
- [18] Drozdov A P *et al* 2019 Superconductivity at 250 K in lanthanum hydride under high pressures *Nature* **569** 528–31
- [19] Snider E, Dasenbrock-Gammon N, McBride R, Meyers N, Lawler K, Salamat A and Dias R P 2020 Superconductivity to 262 kelvin via catalyzed hydrogenation of yttrium at high pressures (arXiv:2012.13627 )
- [20] Snider E, Dasenbrock-Gammon N, McBride R, Debessai M, Vindana H, Vencatasamy K, Lawler K V, Salamat A and Dias R P 2020 Room-temperature superconductivity in a carbonaceous sulfur hydride *Nature* **586** 373–7
- [21] Salamat A, Hector A L, Kroll P and McMillan P F 2013 Nitrogen-rich transition metal nitrides *Coord. Chem. Rev.* **257** 2063–72
- [22] Hall P J and Bain E J 2008 Energy-storage technologies and electricity generation *Energy Policy* **36** 4352–5
- [23] Drozdov A P, Eremets M I, Troyan I A, Ksenofontov V and Shylin S I 2015 Conventional superconductivity at 203 K at high pressures *Nature* **525** 73
- [24] Somayazulu M *et al* 2019 Evidence for superconductivity above 260 K in lanthanum superhydride at megabar pressures *Phys. Rev. Lett.* **122** 027001
- [25] Sun Y *et al* 2019 Route to a superconducting phase above room temperature in electron-doped hydride compounds under high pressure *Phys. Rev. Lett.* **123** 097001
- [26] Cohen M L 2006 Electron–phonon-induced superconductivity *J. Supercond. Novel Magn.* **19** 283
- [27] Cohen M L 2015 Superconductivity in modified semiconductors and the path to higher transition temperatures *Supercond. Sci. Technol.* **28** 043001
- [28] Akashi R, Kawamura M, Tsuneyuki S, Nomura Y and Arita R 2015 First-principles study of the pressure and crystal-structure dependences of the superconducting transition temperature in compressed sulfur hydrides *Phys. Rev. B* **91** 224513
- [29] Sanna A, Davydov A, Dewhurst J K, Sharma S and Flores-Livas J A 2018 Superconductivity in hydrogenated carbon nanostructures *Eur. Phys. J. B* **91** 177
- [30] Snider E, Dasenbrock-Gammon N, McBride R, Debessai M, Vindana H, Vencatasamy K, Lawler K V, Salamat A and Dias R P 2020 *Nature* **586** 373
- [31] Boeri L and Bachelet G B 2019 *J. Phys.: Condens. Matter.* **31** 234002



- [32] Flores-Livas J A *et al* 2020 *Phys. Rep.* **856** 1–78
- [33] Drozdov A P, Erements M I, Troyan I A, Ksenofontov V and Shylin S I 2015 *Nature* **525** 73
- [34] Heil C and Boeri L 2015 *Phys. Rev. B* **92** 06508(R)
- [35] Heil C *et al* 2019 *Phys. Rev. B* **99** 220502(R)
- [36] Errea I *et al* 2020 *Nature* **578** 66
- [37] Semenok D V *et al* 2020 *Curr. Opin. Solid State Mater. Sci.* **24** 100808
- [38] Peng F *et al* 2017 *Phys. Rev. Lett.* **119** 107001
- [39] Flores-Livas J A *et al* 2016 *Phys. Rev. B* **93** 020508(R)
- [40] Quan Y and Pickett W E 2016 *Phys. Rev. B* **93** 104526
- [41] Ashcroft N W 1968 Metallic hydrogen: a high-temperature superconductor? *Phys. Rev. Lett.* **21** 1748
- [42] Babaev E, Sudbø A and Ashcroft N W 2004 A superconductor to superfluid phase transition in liquid metallic hydrogen *Nature* **431** 666–8
- [43] Carlsson A E and Ashcroft N W 1983 Approaches for reducing the insulator-metal transition pressure in hydrogen *Phys. Rev. Lett.* **50** 1305–8
- [44] Hemley R J, Ahart M, Liu H and Somayazulu M 2018 Road to room-temperature superconductivity:  $T_c$  above 260 K in lanthanum superhydride under pressure *Superconductivity and Pressure: A Fruitful Relationship on the Road to Room Temperature Superconductivity* (Madrid, Spain 21–22 May 2018) ed M A Alario y Franco (Madrid: Fundación Ramón Areces) pp 199–213
- [45] Ge Y, Zhang F and Hemley R J 2020 Room-temperature superconductivity in boron-nitrogen doped lanthanum superhydride (arXiv:2012.13398)
- [46] Ge Y, Zhang F, Dias R P, Hemley R J and Yao Y 2020 Hole-doped room-temperature superconductivity in  $H_3S_{1-x}Z_x$  ( $Z = C, Si$ ) *Mater. Today Phys.* **15** 100330
- [47] Kagan M Y and Bianconi A 2019 Fermi–Bose mixtures and BCS-BEC crossover in high- $T_c$  superconductors *Condens. Matter* **4** 51
- [48] Guan P-W, Hemley R J and Viswanathan V 2020 Combining pressure and electrochemistry to synthesize superhydrides (arXiv:2007.15613)
- [49] Liu H, Naumov I I, Geballe Z M, Somayazulu M, Tse J S and Hemley R J 2018 Dynamics and superconductivity in compressed lanthanum superhydride *Phys. Rev. B* **98**
- [50] Hemley R J and Mao H K 1992 *Phys. Lett. A* **163** 429–34
- [51] McMahon J M, Morales M A, Pierleoni C and Ceperley D M 2012 *Rev. Mod. Phys.* **84** 1607–53
- [52] Gregoryanz E, Ji C, Dalladay-Simpson P, Li B, Howie R T and Mao H-K 2020 *Matter Radiat. Extremes* **5** 038101
- [53] Dias R P and Silvera I F 2017 *Science* **355** 715–8
- [54] Erements M I, Drozdov A P, Kong P P and Wang H 2019 *Nat. Phys.* **15** 1246–9
- [55] Loubeyre P, Occelli F and Dumas P 2020 *Nature* **577** 631
- [56] Morales M A, Pierleoni C, Schwegler E and Ceperley D M 2010 *Proc. Natl Acad. Sci.* **107** 12799–803
- [57] Zha C S, Liu H, Tse J S and Hemley R J 2017 *Phys. Rev. Lett.* **119** 075302
- [58] Zaghoo M, Salamat A and Silvera I F 2016 *Phys. Rev. B* **93** 155128
- [59] Celliers P M *et al* 2018 *Science* **361** 677–82
- [60] Knudson M D, Desjarlais M P, Becker A, Lemke R W, Cochrane K R, Savage M E, Bliss D E, Mattsson T R and Redmer R 2015 *Science* **348** 1455–60
- [61] Pierleoni C, Morales M A, Rillo G, Holzmann M and Ceperley D M 2016 *Proc. Natl Acad. Sci.* **113** 4954–7
- [62] Rillo G, Morales M A, Ceperley D M and Pierleoni C 2019 *Proc. Natl Acad. Sci. USA* **116** 9770–4
- [63] Cohen A J, Mori-Sanchez P and Yang W 2008 *Science* **321** 792–4
- [64] Pickett C J and Needs R J 2007 *Nat. Phys.* **3** 473–6
- [65] Pickett C J, Martinez-Canales M and Needs R J 2012 *Phys. Rev. B* **85** 214114
- [66] McMinis J, Clay R C, Lee D and Morales M A 2015 *Phys. Rev. Lett.* **114** 105305
- [67] Morales M A, McMahon J M, Pierleoni C and Ceperley D M 2013 *Phys. Rev. Lett.* **110** 65702
- [68] Morales M A, McMahon J M, Pierleoni C and Ceperley D M 2013 *Phys. Rev. B* **87** 184107
- [69] Pierleoni C and Ceperley D 2006 The coupled electron–ion Monte Carlo method *Lecture Notes in Physics* vol 703 (Berlin: Springer) pp 641–83
- [70] Rillo G, Morales M A, Ceperley D M and Pierleoni C 2018 *J. Chem. Phys.* **148** 102314
- [71] Yang Y, Gorelov V, Pierleoni C, Ceperley D M and Holzmann M 2020 *Phys. Rev. B* **101** 85115
- [72] Gorelov V, Ceperley D M, Holzmann M and Pierleoni C 2020 *J. Chem. Phys.* **153** 234117
- [73] Holzmann M, Clay R, Morales M A, Tubman N M, Ceperley D M and Pierleoni C 2016 *Phys. Rev. B* **94** 035126
- [74] Gorelov V, Holzmann M, Ceperley D M and Pierleoni C 2020 *Phys. Rev. Lett.* **124** 116401
- [75] Gorelov V, Ceperley D M, Holzmann M and Pierleoni C 2020 *Phys. Rev. B* **102** 195133
- [76] Oganov A R 2010 *Modern Methods of Crystal Structure Prediction* (New York: Wiley)
- [77] Drozdov A P *et al* 2019 Superconductivity at 250 K in lanthanum hydride under high pressures *Nature* **528** 569
- [78] Duan D *et al* 2014 Pressure-induced metallization of dense  $(H_2S)_2H_2$  with high- $T_c$  superconductivity *Sci. Rep.* **4** 6968
- [79] Liu H, Naumov I I, Hoffmann R, Ashcroft N W and Hemley R J 2017 Potential high- $T_c$  superconducting lanthanum and yttrium hydrides at high pressure *Proc. Natl Acad. Sci. USA* **114** 6990–5
- [80] Errea I *et al* 2015 High-pressure hydrogen sulfide from first principles: a strongly anharmonic phonon-mediated superconductor *Phys. Rev. Lett.* **114** 157004
- [81] Amsler M, Rostami S, Tahmasbi H, Khajehpasha E R, Faraji S, Rasoulkhani R and Ghasemi S A 2020 FLAME: a library of atomistic modeling environments *Comput. Phys. Commun.* **256** 107415
- [82] Zhou F, Nielson W, Xia Y and Ozoliņš V 2014 Lattice anharmonicity and thermal conductivity from compressive sensing of first-principles calculations *Phys. Rev. Lett.* **113** 185501
- [83] Xia Y, Hegde V I, Pal K, Hua X, Gaines D, Patel S, He J, Aykol M and Wolverton C 2020 High-throughput study of lattice thermal conductivity in binary rocksalt and zinc blende compounds including higher-order anharmonicity *Phys. Rev. X* **10** 041029
- [84] Allahyari Z and Oganov A R 2020 Coevolutionary search for optimal materials in the space of all possible compounds *npj Comput. Mater.* **6** 1–10
- [85] Lv J, Sun Y, Liu H and Ma Y 2020 Theory-orientated discovery of high-temperature superconductors in superhydrides stabilized under high pressure *Matter Radiat. Extremes* **5** 068101
- [86] Zhang L, Wang Y, Lv J and Ma Y 2017 Materials discovery at high pressures *Nat. Rev. Mater.* **2** 17005
- [87] Peng F, Sun Y, Pickett C J, Needs R J, Wu Q and Ma Y 2017 Hydrogen clathrate structures in rare earth hydrides at high pressures: possible route to room-temperature superconductivity *Phys. Rev. Lett.* **119** 107001
- [88] Wang H, Tse J S, Tanaka K, Iitaka T and Ma Y 2012 Superconductive sodalite-like clathrate calcium hydride at high pressures *Proc. Natl Acad. Sci.* **109** 6463
- [89] Ma Y, Erements M, Oganov A R, Xie Y, Trojan I, Medvedev S, Lyakhov A O, Valle M and Prakapenka V 2009 Transparent dense sodium *Nature* **458** 182
- [90] Tong Q, Gao P, Liu H, Xie Y, Lv J, Wang Y and Zhao J 2020 Combining Machine Learning Potential and Structure

- Prediction for Accelerated Materials Design and Discovery *J. Phys. Chem. Lett.* **11** 8710–20
- [91] Hajinazar S, Thorn A, Sandoval E D, Kharabadze S and Kolmogorov A N 2021 MAISE: construction of neural network interatomic models and evolutionary structure optimization *Comput. Phys. Commun.* **259** 107679
- [92] Wu S Q, Ji M, Wang C Z, Nguyen M C, Zhao X, Umamoto K, Wentzcovitch R M and Ho K M 2014 An adaptive genetic algorithm for crystal structure prediction *J. Phys.: Condens. Matter.* **26** 035402
- [93] Behler J and Parrinello M 2007 Generalized neural-network representation of high-dimensional potential-energy surfaces *Phys. Rev. Lett.* **98** 146401
- [94] Zuo Y *et al* 2020 Performance and cost assessment of machine learning interatomic potentials *J. Phys. Chem. A* **124** 731
- [95] Pozdnyakov S N, Willatt M J, Bartók A P, Ortner C, Csányi G and Ceriotti M 2020 Incompleteness of atomic structure representations *Phys. Rev. Lett.* **125** 166001
- [96] Dolgirev P E, Kruglov I A and Oganov A R 2016 Machine learning scheme for fast extraction of chemically interpretable interatomic potentials *AIP Adv.* **6** 085318
- [97] Hajinazar S, Shao J and Kolmogorov A N 2017 Stratified construction of neural network based interatomic models for multicomponent materials *Phys. Rev. B* **95** 014114
- [98] Bernstein N, Csányi G and Deringer V L 2020 De novo exploration and self-guided learning of potential-energy surfaces *npj Comput. Mater.* **5** 99
- [99] Podryabinkin E V, Tikhonov E V, Shapeev A V and Oganov A R 2019 Accelerating crystal structure prediction by machine-learning interatomic potentials with active learning *Phys. Rev. B* **99** 064114
- [100] Ibarra-Hernández W, Hajinazar S, Avendaño-Franco G, Bautista-Hernández A, Kolmogorov A N and Romero A H 2018 Structural search for stable Mg–Ca alloys accelerated with a neural network interatomic model *Phys. Chem. Chem. Phys.* **20** 27545
- [101] Jacobsen T, Jørgensen M and Hammer B 2018 On-the-fly machine learning of atomic potential in density functional theory structure optimization *Phys. Rev. Lett.* **120** 026102
- [102] Rybicki D, Jurkutat M, Reichardt S, Kapusta C and Haase J 2016 Perspective on the phase diagram of cuprate high-temperature superconductors *Nat. Commun.* **7** 6–11
- [103] Grochala W and Hoffmann R 2001 Real and hypothetical intermediate-valence AgII/AgIII and AgII/AgI fluoride systems as potential superconductors *Angew. Chem., Int. Ed.* **40** 2742–81
- [104] Gawraczynski J *et al* 2019 Silver route to cuprate analogs *Proc. Natl Acad. Sci. USA* **116** 1495–1495
- [105] Rybin N, Novoselov D Y, Korotin D M, Anisimov V I and Oganov A R 2020 Novel copper fluoride analogs of cuprates *Phys. Chem. Chem. Phys.* **23** 15989–93
- [106] Yang Y, Wang W-S, Ting C-S and Wang Q-H 2020 Monolayer NbF<sub>4</sub>: a 4d1-analogue of cuprates *Sci. Bull.* **65** 1901–6
- [107] Mounet N *et al* 2018 Two-dimensional materials from high-throughput computational exfoliation of experimentally known compounds *Nat. Nanotechnol.* **13** 246–52
- [108] Bandemehr J, Conrad M and Kraus F 2016 Redetermination of the crystal structure of NbF<sub>4</sub> *Acta Crystallogr. E* **72** 1211–3
- [109] Lyakhov A O, Oganov A R, Stokes H T and Zhu Q 2013 New developments in evolutionary structure prediction algorithm USPEX *Comput. Phys. Commun.* **184** 1172–82
- [110] Kresse G and Furthmüller J 1996 Efficiency of *ab-initio* total energy calculations for metals and semiconductors using a plane-wave basis set *Comput. Mater. Sci.* **6** 15–50
- [111] Lichtenstein A I, Anisimov V I and Zaanen J 1995 Density-functional theory and strong interactions: orbital ordering in Mott–Hubbard insulators *Phys. Rev. B* **52** 5467–71
- [112] Şaşıoğlu E, Friedrich C and Blügel S 2011 Effective Coulomb interaction in transition metals from constrained random-phase approximation *Phys. Rev. B* **83** 121101
- [113] Lin J, Zhang S, Guan W, Yang G and Ma Y 2018 Gold with +4 and +6 oxidation states in AuF<sub>4</sub> and AuF<sub>6</sub> *J. Am. Chem. Soc.* **140** 9545–50
- [114] Kurzydłowski D, Derzsi M, Zurek E and Grochala W 2020 Fluorides of silver under large compression (arXiv:2012.09583)
- [115] Feng J, Grochala W, Jaroń T, Hoffmann R, Bergara A and Ashcroft N W 2006 Structures and potential superconductivity in SiH<sub>4</sub> at high pressure: en route to ‘metallic hydrogen’ *Phys. Rev. Lett.* **96** 017006
- [116] Pickard C J and Needs R J 2006 High-pressure phases of silane *Phys. Rev. Lett.* **97** 045504
- [117] Eremets M I, Trojan I A, Medvedev S A, Tse J S and Yao Y 2008 Superconductivity in hydrogen dominant materials: silane *Science* **319** 1506–9
- [118] Pickard C J, Errea I and Eremets M I 2020 Superconducting hydrides under pressure *Annu. Rev. Condens. Matter Phys.* **11** 57–76
- [119] Pickard C J, Martínez-Canales M and Needs R J 2013 Decomposition and terapascal phases of water ice *Phys. Rev. Lett.* **110** 245701
- [120] Pickard C J and Needs R J 2011 *Ab initio* random structure searching *J. Phys.: Condens. Matter.* **23** 053201
- [121] Monserrat B, Drummond N D, Dalladay-Simpson P, Howie R T, López Ríos P, Gregoryanz E, Pickard C J and Needs R J 2018 Structure and metallicity of phase V of hydrogen *Phys. Rev. Lett.* **120** 255701
- [122] Deringer V L, Pickard C J and Csányi G 2018 Data-driven learning of total and local energies in elemental boron *Phys. Rev. Lett.* **120** 156001
- [123] Falls Z, Avery P, Wang X, Hilleke K P and Zurek E 2020 The XtalOpt evolutionary algorithm for crystal structure prediction *J. Phys. Chem. C* **125** 1601–20
- [124] Bi T, Zarifi N, Terpstra T and Zurek E 2019 The search for superconductivity in high pressure hydrides *Elsevier Reference Module in Chemistry, Molecular Sciences and Chemical Engineering* ed J Reedijk (Waltham, MA: Elsevier) pp 1–36
- [125] Cui W, Bi T, Shi J, Li Y, Liu H, Zurek E and Hemley R J 2020 Route to high-*T<sub>c</sub>* superconductivity via CH<sub>4</sub>-intercalated H<sub>3</sub>S hydride perovskites *Phys. Rev. B* **101** 134504
- [126] Sun Y, Tian Y, Jiang B, Li X, Li H, Iitaka T, Zhong X and Xie Y 2020 Computational discovery of a dynamically stable cubic SH<sub>3</sub>-like high-temperature superconductor at 100 GPa via CH<sub>4</sub> intercalation *Phys. Rev. B* **101** 174102
- [127] Yan Y, Bi T, Geng N, Wang X and Zurek E 2020 A metastable CaSH<sub>3</sub> phase composed of HS honeycomb sheets that is superconducting under pressure *J. Phys. Chem. Lett.* **11** 9629–36
- [128] Ge Y, Zhang F, Dias R P, Hemley R J and Yao Y 2020 Holographic room-temperature superconductivity in H<sub>3</sub>S<sub>1-x</sub>Z<sub>x</sub> (Z = C, Si) *Mater. Today Phys.* **15** 2542
- [129] Flores-Livas J A, Boeri L, Sanna A, Profeta G, Arita R and Eremets M 2020 A perspective on conventional high-temperature superconductors at high pressure: methods and materials *Phys. Rep.* **856** 1
- [130] e.g. Wang T, Nomoto T, Nomura Y, Shinaoka H, Otsuki J, Koretsune T and Arita R 2020 Efficient *ab initio* Migdal–Eliashberg calculation considering the retardation effect in phonon-mediated superconductors *Phys. Rev. B* **102** 134503
- [131] Wang T, Hirayama M, Nomoto T, Koretsune T, Arita R and Flores-Livas J A 2021 Absence of conventional room temperature superconductivity at high pressure in carbon doped H<sub>3</sub>S (arXiv:2104.03710)

- [132] Davydov A, Sanna A, Pellegrini C, Dewhurst J K, Sharma S and Gross E K U 2020 *Ab initio* theory of plasmonic superconductivity within the Eliashberg and density-functional formalisms *Phys. Rev. B* **102** 214508
- [133] Schrodi F, Aperis A and Oppeneer P M 2020 Eliashberg theory for spin fluctuation mediated superconductivity: application to bulk and monolayer FeSe *Phys. Rev. B* **102** 014502
- [134] Kontani H and Onari S 2010 Orbital-fluctuation-mediated superconductivity in iron pnictides: analysis of the five-orbital Hubbard–Holstein model *Phys. Rev. Lett.* **104** 157001
- [135] Imada M and Miyake T 2010 Electronic structure calculation by first principles for strongly correlated electron systems *J. Phys. Soc. Japan* **79** 112001
- [136] LeBlanc J P F *et al* 2015 Solutions of the two-dimensional Hubbard model: benchmarks and results from a wide range of numerical algorithms *Phys. Rev. X* **5** 041041
- [137] Drozdov A P, Eremets M I, Troyan I A, Ksenofontov V and Shylin S I 2020 Conventional superconductivity at 203 kelvin at high pressures in the sulfur hydride system *Nature* **525** 73
- [138] Errea I *et al* 2016 Quantum hydrogen-bond symmetrization in the superconducting hydrogen sulfide system *Nature* **532** 81
- [139] Allen P B and Cohen M L 1972 Superconductivity and phonon softening *Phys. Rev. Lett.* **29** 1593
- [140] Oliveira L N, Gross E K U and Kohn W 1988 Density-functional theory for superconductors *Phys. Rev. Lett.* **60** 2430
- [141] Lüders M, Marques M A L, Lathiotakis N N, Floris A, Profeta G, Fast L, Continenza A, Massidda S and Gross E K U 2005 *Ab initio* theory of superconductivity: I. Density functional formalism and approximate functionals *Phys. Rev. B* **72** 024545  
Marques M A L, Lüders M, Lathiotakis N N, Profeta G, Floris A, Fast L, Continenza A, Gross E K U and Massidda S 2005 *Ab initio* theory of superconductivity: II. Application to elemental metals *Phys. Rev. B* **72** 024546
- [142] Sanna A, Pellegrini C and Gross E K U 2020 Combining Eliashberg theory with density functional theory for the accurate prediction of superconducting transition temperatures and gap functions *Phys. Rev. Lett.* **125** 057001
- [143] Essenerberger F, Sanna A, Linscheid A, Tandetzky F, Profeta G, Cudazzo P and Gross E K U 2014 Superconducting pairing mediated by spin fluctuations from first principles *Phys. Rev. B* **90** 214504
- [144] Stewart G R 2017 Unconventional superconductivity *Adv. Phys.* **66** 75
- [145] Akashi R and Arita R 2013 Development of density-functional theory for a plasmon-assisted superconducting state: application to lithium under high pressures *Phys. Rev. Lett.* **111** 057006
- [146] Pietronero L, Strässler S and Grimaldi C 1995 Nonadiabatic superconductivity: I. Vertex corrections for the electron–phonon interactions *Phys. Rev. B* **52** 10516
- [147] See chapter section 14 by Ryotaro Arita in this issue
- [148] Requist R, Proetto C R and Gross E K U 2019 Exact factorization-based density functional theory of electron–phonon systems *Phys. Rev. B* **99** 165136
- [149] Abedi A, Maitra N T and Gross E K U 2010 Exact factorization of the time-dependent electron-nuclear wave function *Phys. Rev. Lett.* **105** 123002
- [150] Härkönen V J, van Leeuwen R and Gross E K U 2020 Many-body Green’s function theory of electrons and nuclei beyond the Born–Oppenheimer approximation *Phys. Rev. B* **101** 235153
- [151] Margine E R and Giustino F 2013 Anisotropic Migdal–Eliashberg theory using Wannier functions *Phys. Rev. B* **87** 024505
- [152] Giustino F, Cohen M L and Louie S G 2007 Electron–phonon interaction using Wannier functions *Phys. Rev. B* **76** 165108
- [153] Poncé S, Margine E R, Verdi C and Giustino F 2016 EPW: electron–phonon coupling, transport and superconducting properties using maximally localized Wannier functions *Comput. Phys. Commun.* **209** 116
- [154] Lafuente-Bartolome J, Gurtubay I G and Eiguren A 2020 Fully anisotropic superconductivity with few Helmholtz Fermi-surface harmonics *Phys. Rev. B* **102** 161107(R)
- [155] Heil C, Poncé S, Lambert H, Schlipf M, Margine E R and Giustino F 2017 Origin of superconductivity and latent charge density wave in NbS<sub>2</sub> *Phys. Rev. Lett.* **119** 087003
- [156] Sanna A, Flores-Livas J A, Davydov A, Profeta G, Dewhurst K, Sharma S and Gross E K U 2018 *Ab initio* Eliashberg theory: making genuine predictions of superconducting features *J. Phys. Soc. Japan* **87** 041012
- [157] Schrodi F, Oppeneer P M and Aperis A 2020 Full-bandwidth Eliashberg theory of superconductivity beyond Migdal’s approximation *Phys. Rev. B* **102** 024503
- [158] Li Z, Antonius G, Wu M, da Jornada F H and Louie S G 2019 Electron–phonon coupling from *ab initio* linear-response theory within the GW method: correlation-enhanced interactions and superconductivity in Ba<sub>1-x</sub>K<sub>x</sub>BiO<sub>3</sub> *Phys. Rev. Lett.* **122** 186402
- [159] Curtarolo S, Hart G L W, Nardelli M B, Mingo N, Sanvito S and Levy O 2013 The high-throughput highway to computational materials design *Nat. Mater.* **12** 191
- [160] Xie S R, Stewart G R, Hamlin J J, Hirschfeld P J and Hennig R G 2019 Functional form of the superconducting critical temperature from machine learning *Phys. Rev. B* **100** 174513
- [161] Tanifuji M, Matsuda A and Yoshikawa H 2019 Materials data platform—a FAIR system for data-driven materials science 2019 8th Int. Congress on Advanced Applied Informatics (IIAI-AAI) pp 1021–2
- [162] Stanev V, Oses C, Kusne A G, Rodriguez E, Paglione J, Curtarolo S and Takeuchi I 2018 Machine learning modeling of superconducting critical temperature *npj Comput. Mater.* **4** 29
- [163] Hutcheon M J, Shipley A M and Needs R J 2020 Predicting novel superconducting hydrides using machine learning approaches *Phys. Rev. B* **101** 144505
- [164] Tipton W W and Hennig R G 2013 A grand canonical genetic algorithm for the prediction of multi-component phase diagrams and testing of empirical potentials *J. Phys.: Condens. Matter* **25** 495401
- [165] Friederich P, Häse F, Proppe J and Aspuru-Guzik A 2021 Machine-learned potentials for next-generation matter simulations *Nat. Mater.* **20** 750–61
- [166] Scalapino D J 2012 A common thread: the pairing interaction for unconventional superconductors *Rev. Mod. Phys.* **84** 1383
- [167] Xie S R *et al* 2021 Machine learning of superconducting critical temperature from Eliashberg theory (arXiv:2106.05235)
- [168] Konno T, Kurokawa H, Nabeshima F, Sakishita Y, Ogawa R, Hosako I and Maeda A 2021 Deep learning model for finding new superconductors *Phys. Rev. B* **103** 014509
- [169] Iten R *et al* 2020 Discovering physical concepts with neural networks *Phys. Rev. Lett.* **124** 010508
- [170] Schmidt M and Lipson H 2009 Distilling free-form natural laws from experimental data *Science* **324** 81–5
- [171] Udrescu S-M and Tegmark M 2020 AI Feynman: a physics-inspired method for symbolic regression *Sci. Adv.* **6** eaay2631
- [172] Ishikawa T, Miyake T and Shimizu K 2019 Materials informatics based on evolutionary algorithms: application to search for superconducting hydrogen compounds *Phys. Rev. B* **100** 174506

- [173] Liu Z-L, Kang P, Zhu Y, Liu L and Guo H 2020 Material informatics for layered high- $T_c$  superconductors featured *APL Mater.* **8** 061104
- [174] Franceschetti A and Zunger A 1999 The inverse band-structure problem of finding an atomic configuration with given electronic properties *Nature* **402** 60–3
- [175] Noh J, Kim J, Stein H S, Sanchez-Lengeling B, Gregoire J M, Aspuru-Guzik A and Jung Y 2019 Inverse design of solid-state materials via a continuous representation *Matter* **1** 1370–84
- [176] Ling J, Hutchinson M, Antono E, Paradiso S and Meredig B 2017 High-dimensional materials and process optimization using data-driven experimental design with well-calibrated uncertainty estimates *Integr. Mater. Manuf. Innov.* **6** 207–17
- [177] Zhang Y *et al* 2019 Machine learning in electronic-quantum-matter imaging experiments *Nature* **570** 484–90
- [178] Court C J and Cole J M 2020 Magnetic and superconducting phase diagrams and transition temperatures predicted using text mining and machine learning *npj Comput. Mater.* **6** 18
- [179] Stritzker B and Buckel W 1972 Superconductivity in the palladium–hydrogen and the palladium–deuterium systems *Z. Phys.* **257** 1–8
- [180] Satterthwaite C B and Toepke I L 1970 Superconductivity of hydrides and deuterides of thorium *Phys. Rev. Lett.* **25** 741–3
- [181] Stritzker B 1974 High superconducting transition temperatures in the palladium-noble metal-hydrogen system *Z. Phys.* **268** 261–4
- [182] Syed H M, Webb C J and Gray E M 2016 Hydrogen-modified superconductors: a review *Prog. Solid State Chem.* **44** 20–34
- [183] Cui Y *et al* 2019 Ionic-liquid-gating induced protonation and superconductivity in FeSe, FeSe<sub>0.93</sub>S<sub>0.07</sub>, ZrNCl, 1T-TaS<sub>2</sub> and Bi<sub>2</sub>Se<sub>3</sub> *Chin. Phys. Lett.* **36** 077401
- [184] Syed H M, Gould T J, Webb C J and MacA G E 2016 Superconductivity in palladium hydride and deuteride at 52–61 kelvin (arXiv:1608.01774)
- [185] Lu N *et al* 2017 Electric-field control of tri-state phase transformation with a selective dual-ion switch *Nature* **546** 124–8
- [186] Rafique M, Feng Z, Lin Z, Wei X, Liao M, Zhang D, Jin K and Xue Q-K 2019 Ionic liquid gating induced protonation of electron-doped cuprate superconductors *Nano Lett.* **19** 7775–80
- [187] Errea I, Calandra M and Mauri F 2013 First-principles theory of anharmonicity and the inverse isotope effect in superconducting palladium-hydride compounds *Phys. Rev. Lett.* **111** 177002
- [188] Bianco R, Errea I, Paulatto L, Calandra M and Mauri F 2017 Second-order structural phase transitions, free energy curvature, and temperature-dependent anharmonic phonons in the self-consistent harmonic approximation: theory and stochastic implementation *Phys. Rev. B* **96** 014111
- [189] Bednorz J G and Müller K A 1986 Possible high- $T_c$  superconductivity in the Ba–La–Cu–O system *Z. Phys. B* **64** 189
- [190] Bardeen J, Cooper L N and Schrieffer J R 1957 Theory of superconductivity *Phys. Rev.* **108** 1175
- [191] Steglich F, Aarts J, Bredl C D, Lieke W, Meschede D, Franz W and Schäfer H 1979 Superconductivity in the presence of strong Pauli paramagnetism: CeCu<sub>2</sub>Si<sub>2</sub> *Phys. Rev. Lett.* **43** 1892
- [192] Jérôme D, Mazaud A, Ribault M and Bechgaard K 1980 Superconductivity in a synthetic organic conductor (TMTSF)<sub>2</sub>PF<sub>6</sub> *J. Phys. Lett.* **41** 95
- [193] Parkin S S P, Engler E M, Schumaker R R, Lagier R, Lee V Y, Scott J C and Greene R L 1983 Superconductivity in a new family of organic conductors *Phys. Rev. Lett.* **50** 270
- [194] Maeno Y, Hashimoto H, Yoshida K, Nishizaki S, Fujita T, Bednorz J G and Lichtenberg F 1994 Superconductivity in a layered perovskite without copper *Nature* **372** 532
- [195] Kamihara Y, Watanabe T, Hirano M and Hosono H 2008 Iron-based layered superconductor La[O<sub>1-x</sub>F<sub>x</sub>]FeAs ( $x = 0.05$ – $0.12$ ) with  $T_c = 26$  K *J. Am. Chem. Soc.* **130** 3296
- [196] Cao Y, Fatemi V, Fang S, Watanabe K, Taniguchi T, Kaxiras E and Jarillo-Herrero P 2018 Unconventional superconductivity in magic-angle graphene superlattices *Nature* **556** 43
- [197] Mazin I I, Jeschke H O, Lechermann F, Lee H, Fink M, Thomale R and Valentí R 2014 Theoretical prediction of a strongly correlated Dirac metal *Nat. Commun.* **5** 1
- [198] Yin Z P, Haule K and Kotliar G 2014 Spin dynamics and orbital-antiphase pairing symmetry in iron-based superconductors *Nat. Phys.* **10** 845
- [199] Held K 2018 Quantum criticality and superconductivity in diagrammatic extensions of DMFT *Rev. Mod. Phys.* **90** 025003
- [200] Kreisel A, Andersen B M, Sprau P O, Kostin A, Davis J C S and Hirschfeld P J 2017 Orbital selective pairing and gap structures of iron-based superconductors *Phys. Rev. B* **95** 174504
- [201] Zantout K, Altmeyer M, Backes S and Valentí R 2018 Superconductivity in correlated BEDT-TTF molecular conductors: critical temperatures and gap symmetries *Phys. Rev. B* **97** 014530
- [202] Glasbrenner J K, Mazin I I, Jeschke H O, Hirschfeld P J, Fernandes R M and Valentí R 2015 Effect of magnetic frustration on nematicity and superconductivity in iron chalcogenides *Nat. Phys.* **11** 953
- [203] Borisov V, Canfield P C and Valentí R 2018 Trends in pressure-induced layer-selective half-collapsed tetragonal phases in the iron-based superconductor family AeAF<sub>4</sub>As<sub>4</sub> *Phys. Rev. B* **98** 064104
- [204] Court C J and Cole J M 2020 Magnetic and superconducting phase diagrams and transition temperatures predicted using text mining and machine learning *npj Comput. Mater.* **6** 1
- [205] Mertz T and Valentí R 2020 Engineering topological phases guided by statistical and machine learning methods (arXiv:2008.11213)
- [206] Ran S *et al* 2019 Nearly ferromagnetic spin-triplet superconductivity *Science* **365** 684
- [207] Charpentier S, Galletti L, Kunakova G, Arpaia R, Song Y, Baghdadi R and Golubev D 2017 Induced unconventional superconductivity on the surface states of Bi<sub>2</sub>Te<sub>3</sub> topological insulator *Nat. Commun.* **8** 1